

- SIGN LEGEND**
- A** NON-ILLUMINATED Exterior Display w/ FCO Copy on Backer Panel
REF. DWG. KS2001705 for specs. & details
 - B** NON-ILLUMINATED Exterior Display w/ FCO Copy on Backer Panel
REF. DWG. KS2001705A for specs. & details
 - C** DOOR VINYL ONLY
REF. DWG. KS2001705B for specs. & details

- Page 1 - Site Map
- Page 2 - Non Illuminated Sign
- Page 3 - Non Illuminated Sign
- Page 4 - Door Vinyl
- Page 5 - Existing Tenant Sign-no changes
- Page 6 - Signage in Area

Kieffer | Starlite
National Sign Manufacturers and Consultants
Dallas/Ft. Worth | Chicago | Sheboygan | Charlotte

ACCOUNT: Whitecap Const. & Safety Supply
 LOCATION: 617 Salsipuedes, St. Store: #061
 ACCT. REP: Jennifer Lee DESIGNER: LMK
 DATE: 05/24/21
 COMPANION FILES: _____

REVISIONS:	INITIALS & DATE:
▲ Clean up site plan	MSO 7/2/21
▲ Per Request	TVS 09/30/21
▲ -	-
▲ -	-
▲ -	-
▲ -	-
▲ -	-
▲ -	-
▲ -	-

This is an original unpublished drawing submitted for use in connection with a project being planned for you by Kieffer Holding Co. It is not to be reproduced, copied or exhibited in any fashion without the written permission of Kieffer Holding Company.



**For Contact Information
visit us at
www.kssigngroup.com**

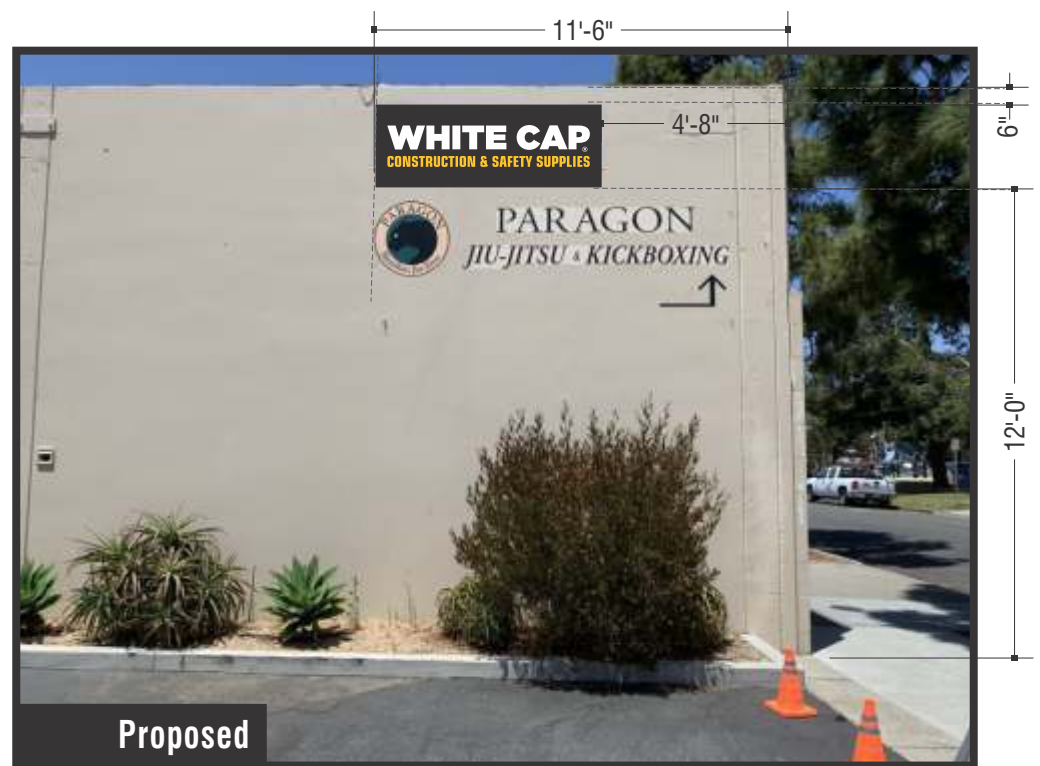



A Non-Illuminated Exterior Display 17.08
FCO Copy Scale: 1/2" = 1'-0"

Color Schedule

Paint	
	PMS 100% Black
	PMS 100% White
	PMS #123c Golden Yellow

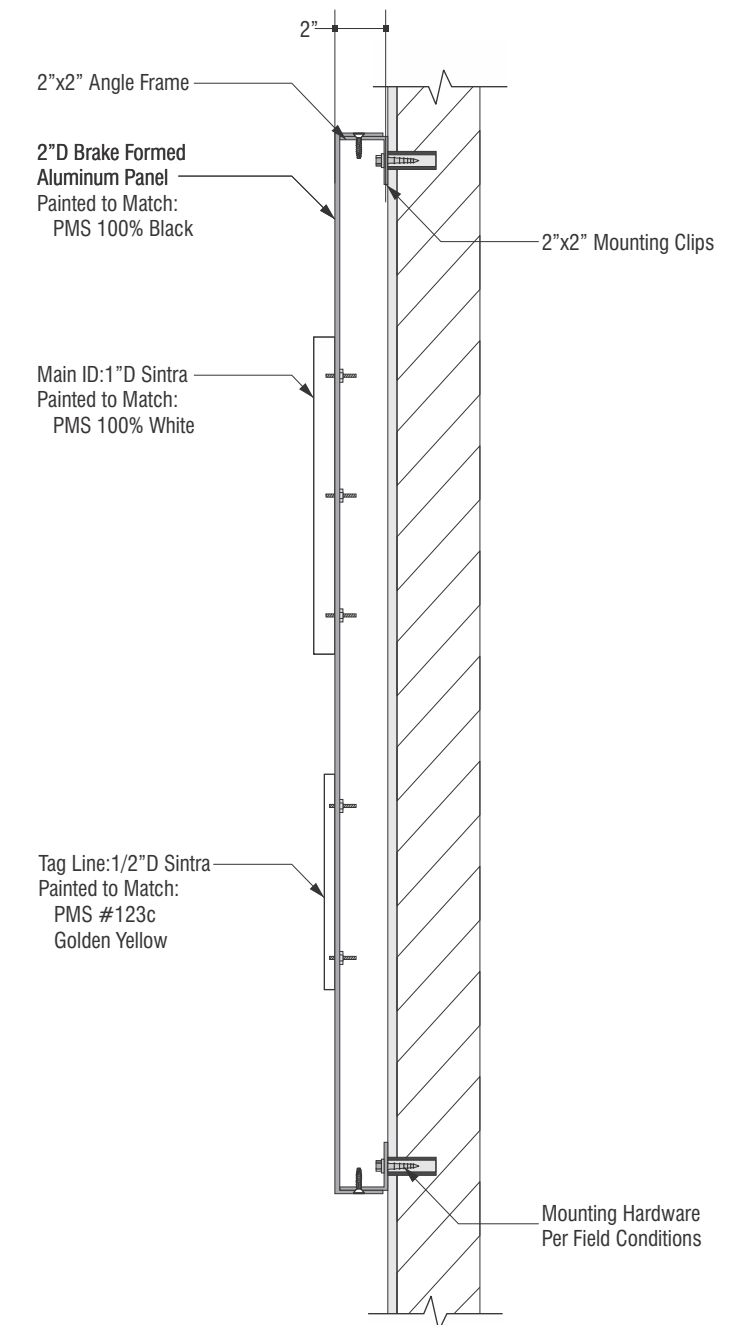

Non-Illuminated Exterior Display - FCO Copy
Scale: NTS

Landlord Initials _____

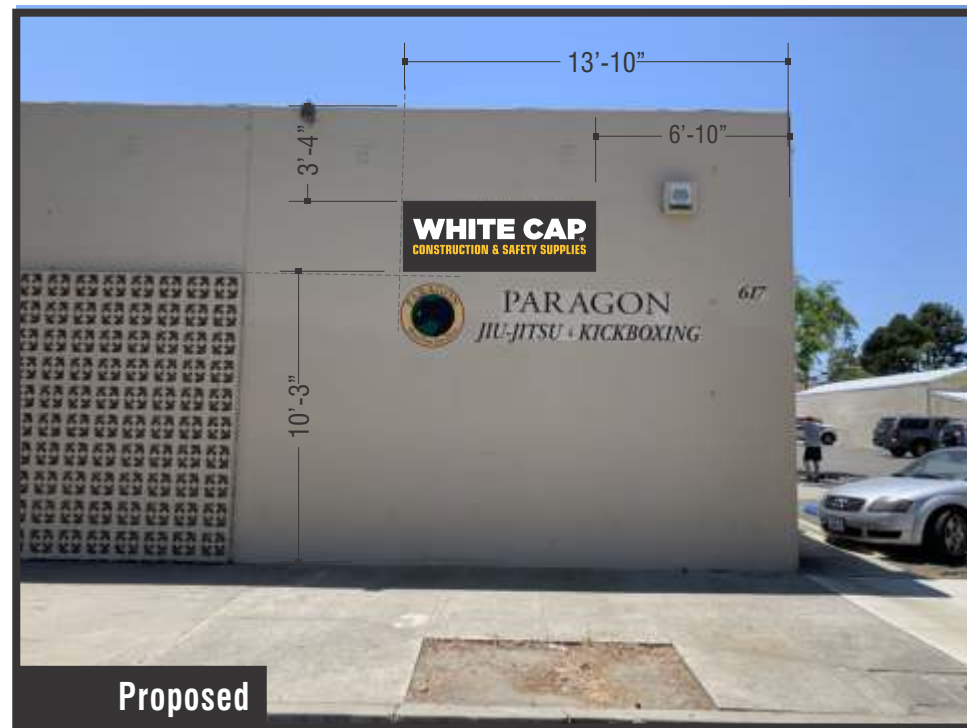
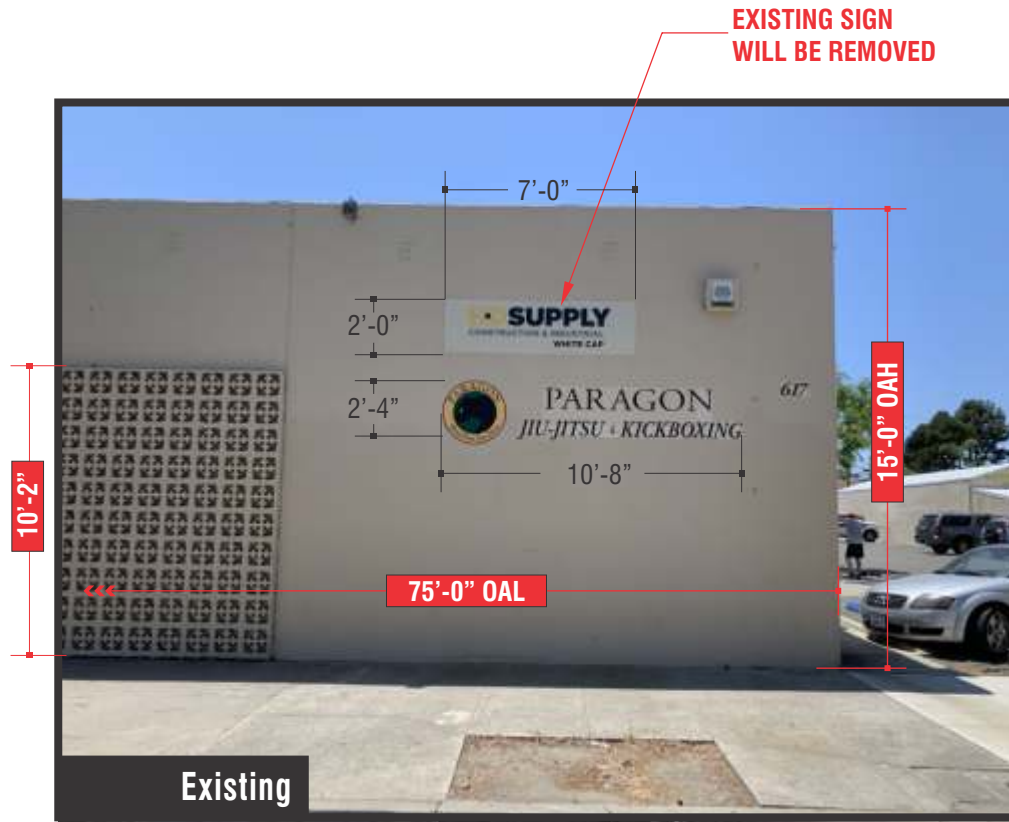

B Non-Illuminated Exterior Display 17.08
FCO Copy Scale: 1/2" = 1'-0"

Color Schedule

Paint	
	PMS 100% Black
	PMS 100% White
	PMS #123c Golden Yellow

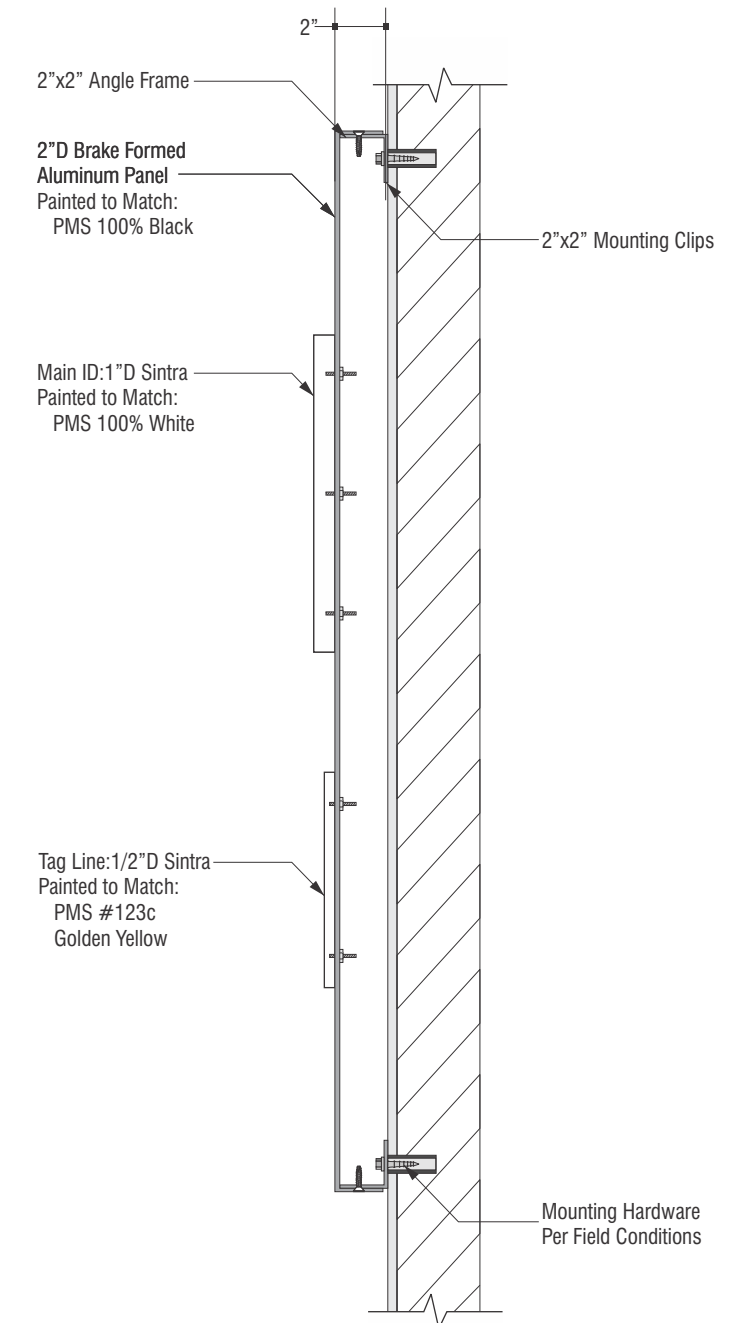

Non-Illuminated Exterior Display - FCO Copy
Scale: NTS

Landlord Initials _____

A	Building dimensions added.	INITIALS & DATE:	LMK 5/24/21
B	add sign placement dims		MSO 7/2/21
C	Revise elevation OAL		TVS - 10/07/21
D	-		-
E	-		-
F	-		-
G	-		-
H	-		-

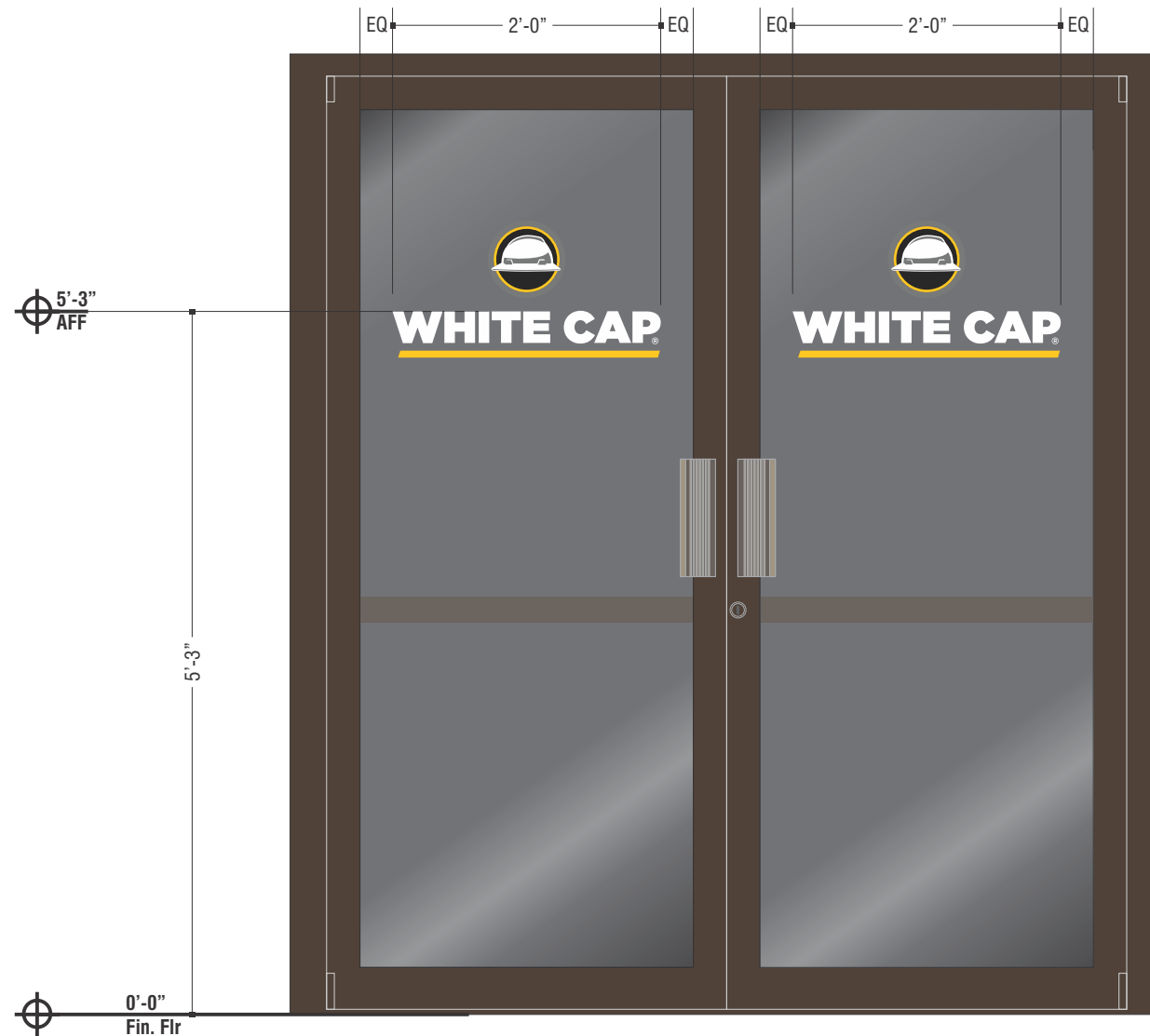

Door Vinyl Application

Scale: 3/4" = 1'-0"

GLASS DIMENSIONS WILL BE REQUIRED PRIOR TO MANUFACTURE

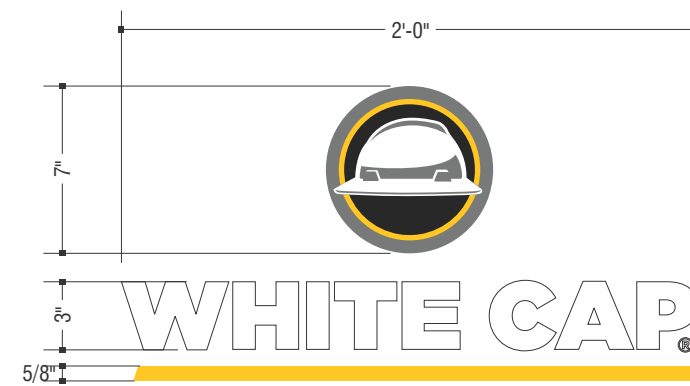

C Vinyl Graphics
(2) Sets Required

Scale: 1 1/2" = 1'-0"



General Description

First surface applied flat cut vinyl graphics.

-See **Color Schedule** for details and specifications

Color Schedule

Vinyl

-  **3M#7725-10**
White
-  **3M#7725-25**
Golden Yellow
-  **PMS #424c**
Gray

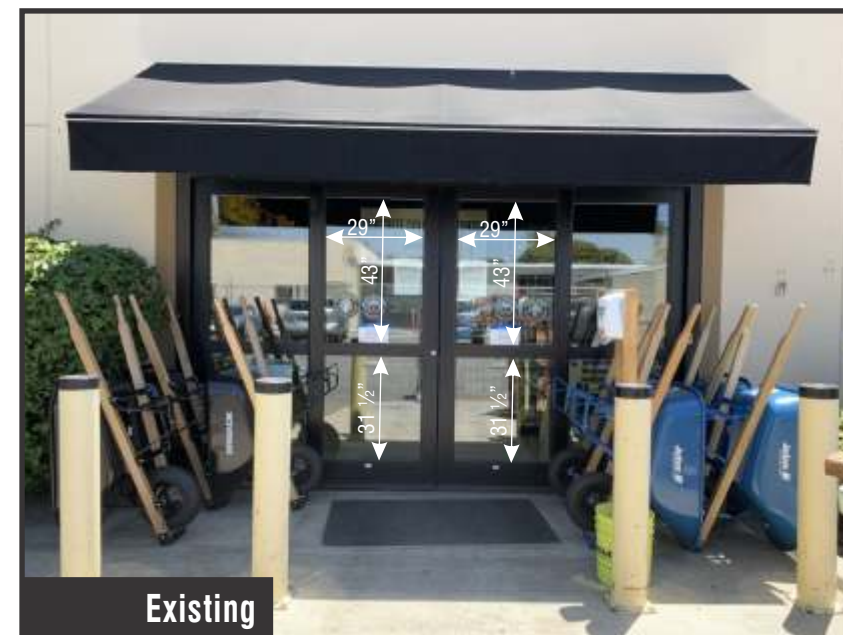

Landlord Initials _____



NO CHANGES TO THIS SIGN

Landlord Initials _____

REVISIONS:	INITIALS & DATE:
▲ A -	-
▲ B -	-
▲ C -	-
▲ D -	-
▲ E -	-
▲ F -	-
▲ G -	-
▲ H -	-



RJ CARROL & SONS PLUMBING - 648 N. SALSIPUEDES



SPORT CYCLE PACIFIC - 627 N. SALSIPUEDES



HOUSE OF CLUES - 629 N. SALSIPUEDES



ACTION ROOFING - 534 E. ORTEGA STREET



GIRLS INC. GREATER SANTA BARBARA - 531 E. ORTEGA STREET



PERFORMING ARTS CENTER - 599 E. COTA STREET

Landlord Approval Signature: _____

Printed Name: _____