

**CITY OF SANTA BARBARA**  
**PUBLIC WORKS DEPARTMENT WATER RESOURCES DIVISION**

***Memorandum***

**DATE:** March 20, 2025  
**TO:** Water Commission  
**VIA:** Joshua Haggmark, Water Resources Manager  
**FROM:** Kelly Bourque, Senior Project Engineer  
**SUBJECT:** Vic Trace Reservoir Replacement Project Update

**RECOMMENDATION**

That the Water Commission receive a report on updates to the Vic Trace Reservoir Replacement Project.

**DISCUSSION**

**Background**

The Vic Trace Reservoir is located at 740 Dolores Drive in the City of Santa Barbara's (City) Mesa neighborhood. The facility was constructed in 1956 as a partially buried, 10-million-gallon (MG) concrete reservoir used for treated drinking water storage. The City identified the Vic Trace Reservoir Replacement Project (Project) as critical in its Water Distribution Infrastructure Plan (WDIP). The WDIP provides strategic guidance and recommendations to address the City's water distribution needs through the Planning Year 2050. As the City's second largest reservoir, Vic Trace Reservoir was recommended for replacement due to its age, increasing repair needs, and importance to the City's overall drinking water system. The Project's key benefits include bringing the reservoir up to current seismic standards, extended service life, improved water quality protection, water supply resilience, improved site drainage, landscaping, and enhanced security.

**Design**

The Project's Preliminary Design Report (PDR) was completed in February 2025 and includes project drawings at roughly 15% development phase (final design will be at the 100% phase). The project's preliminary design includes the following key elements:

- Two 5 MG buried (circular) pre-stressed concrete tanks that meet current seismic codes
- Site improvements – access roads, stormwater compliance, improved grading and terracing, and security
- Replacement of La Coronilla Pump Station and Valve Building onsite
- Relocation of Infrastructure Technology (IT) facilities and facility consolidation
- La Coronilla Transmission Main relocation from private easements to the right-of-way
- Relocation of the La Vista Del Oceano Pressure Reducing Valve station (PRV) to Dolores Drive

Before proceeding with the next phase of design (30%), the City will engage directly with the public, Community Development and other City departments. Additionally, the City will finalize its project description to begin its

environmental review process. Engaging the public at this early stage ensures feedback is comprehensively considered and incorporated, as well as mitigating future, costly design changes.

### **Community Outreach**

The City and Katz and Associates (K&A) completed a comprehensive Strategic Communication Plan for the Project's public outreach. The plan identifies stakeholders, sets Project messaging, and outlines specific methods of community engagement through design, environmental, pre- and post-construction phases. The City will be conducting its first Community Engagement Workshop on May 1, 2025 from 5:30 P.M. to 7:00 P.M. at Monroe Elementary School in the Mesa neighborhood as outlined in the plan. The purpose of the in-person meeting is to introduce the project and project renderings, solicit preliminary feedback, answer questions, and make City staff available to engage with community members directly. Key details of the Community Engagement Workshop are noted below:

- Attendance sign-in and opt-in to the project's subscription email notifications
- Brief presentation and staff introductions
- Posterboard materials with comment cards
- Open house (1:1) question and answer session with staff and consultants

Following the workshop on May 7, 2025, at 5:30 P.M., the City will host an online webinar for those who cannot attend the workshop in-person. The webinar will be recorded and posted to the Project's website ([www.santabarbaraca.gov/VicTrace](http://www.santabarbaraca.gov/VicTrace)).

The City estimates 50 community members will attend, along with at least ten City staff and consultants. Workshop noticing includes:

- Direct mailers
- Press release
- Emails to Project subscribers
- Posting on the City's News in Brief, social media, event calendar, and NextDoor
- Sharing with Santa Barbara Unified School District to post to ParentSquare

After the Community Engagement Workshop, the City anticipates up to thirty public and community meetings related to the Project. These meetings include formal presentations to City Boards and Commissions (e.g., Architectural Board of Review, Planning Commission, City Council), CEQA public meetings, and additional engagement meetings with the community and neighborhood throughout both design and construction. These are summarized in the Project's [Strategic Communication Plan](#), posted to the Project's website.

### **Environmental Process**

This Project requires California Environmental Quality Act (CEQA) compliance and permitting. The City completed its Phase 1 environmental review in 2023 with Rincon Consultants, Inc. (Rincon). Continuing to work with Rincon, the City will initiate its CEQA Environmental Impact Review (EIR) process this year. This fall, the City anticipates distributing a CEQA Initial Study for public review. The Initial Study will be presented and discussed at a Public Scoping Meeting (Fall 2025). Project resource areas of concern include air quality, biology, cultural resources, hazards and hazardous materials, noise, and sustainability. The Project's EIR will be drafted and presented to Water Commission, the Planning Commission and City Council over the next two years, with final certification anticipated in Spring 2027.

### Planning Application

The Project's Pre-Application Review (PRE) will be submitted to Community Development in March 2025. The purpose of the PRE is for early consultation on various design items, including zoning compliance, required City approvals (e.g., Fire, Sustainability and Resilience, etc.), and a design concept consultation with the Architectural Board of Review (ARB). The ARB presentation is scheduled for summer 2025 following the Community Engagement Workshop. The City and KJ's Architect will present the Project's drawings, renderings, and any notable public design feedback.

### Project Cost

The current estimated total Project cost is \$129M. The cost increase is driven by an updated construction cost estimate of \$113M that reflects the current Project design elements and contingencies. This includes the final reservoir replacement design, site improvements (grading, access roads, fire-safe landscaping, stormwater compliance), and the relocation of the transmission main and the pressure-reducing valve station. This number also includes several contingencies that capture current design uncertainties and unknown market conditions, typical of engineering cost estimates performed during the preliminary design phase. As the design progresses through 30%, 60%, and 100% phases, the construction cost estimate will be further refined with less contingencies applied. Costs presented below include current and future City contracts, and City staff costs.

	<b>AMOUNT</b>
<b>DESIGN</b>	\$5M
<b>COMMUNITY OUTREACH</b>	\$1M
<b>ENVIRONMENTAL</b>	\$1M
<b>CONSTRUCTION</b>	\$113M
<b>TOTAL</b>	<b>\$129M</b>

### Timeline

The Project's timeline remains on track with the final design to be initiated in Summer 2025 and construction starting in 2028. Upcoming Project milestones for Water Commission include:

- Award of Phase 2 Design Contract (Water Commission and City Council) – Summer 2025
- CEQA Initial Study and Public Scoping Meeting – Summer 2025

**ATTACHMENT:** Preliminary Drawings And Renderings



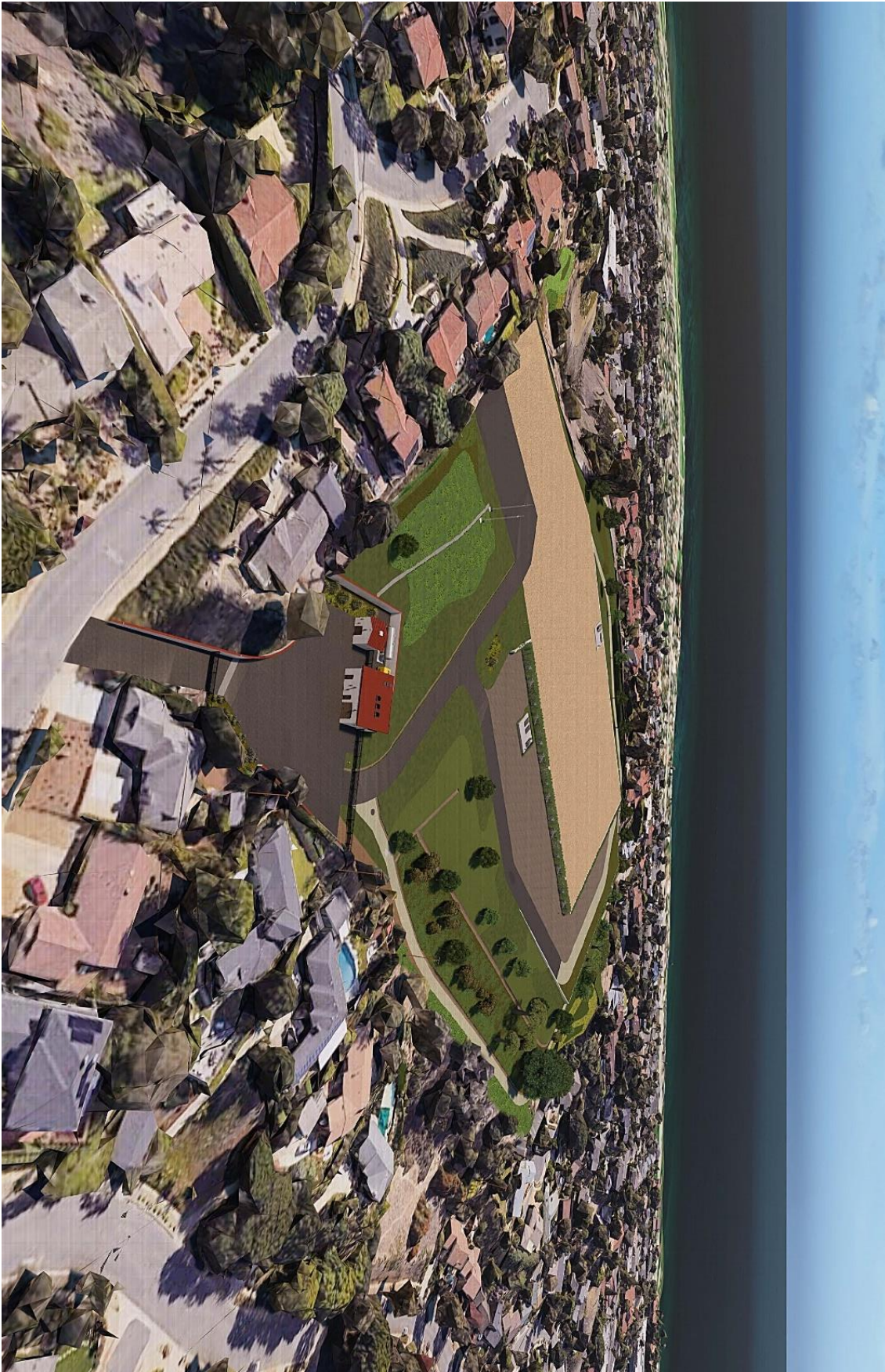





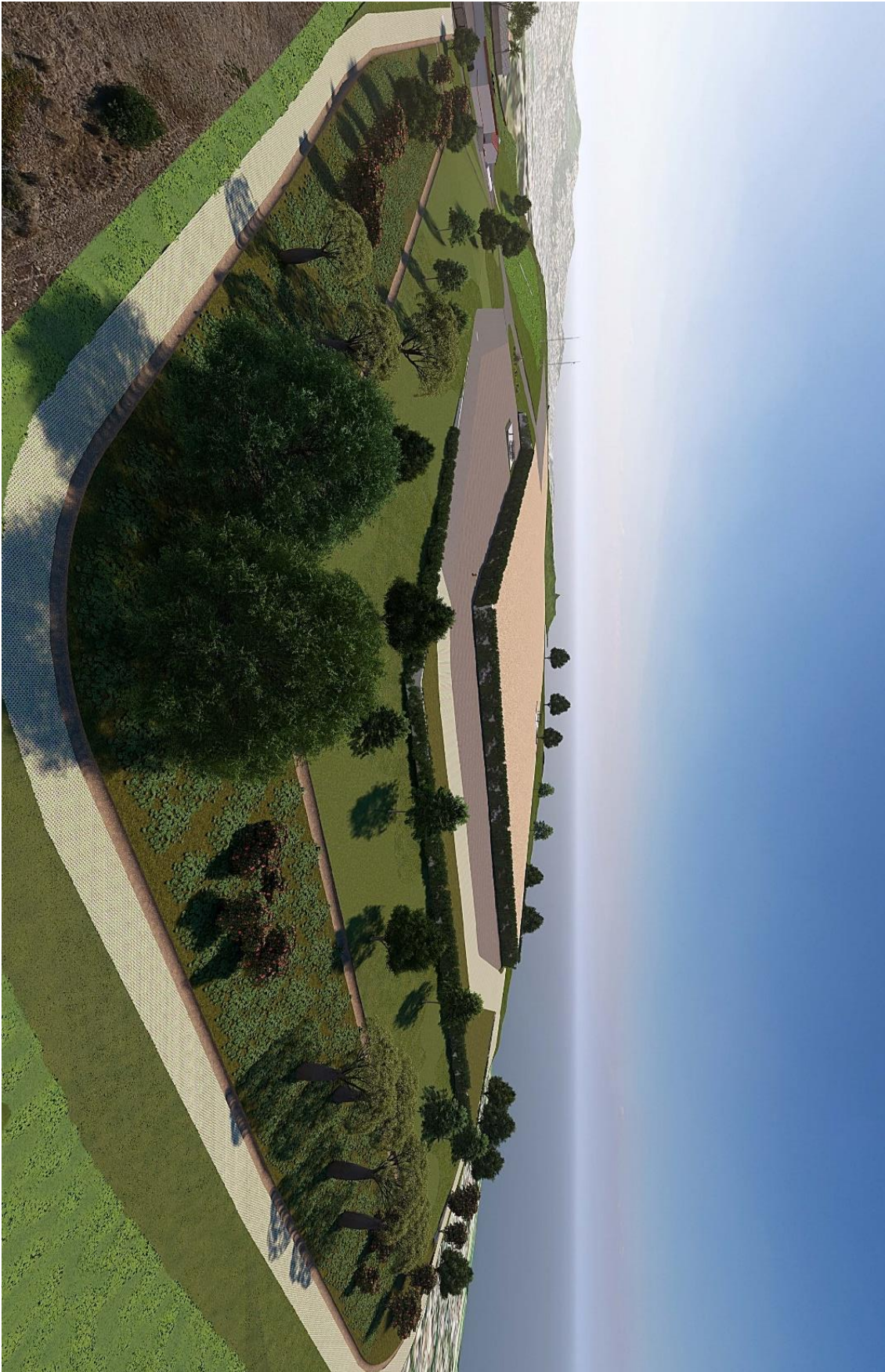













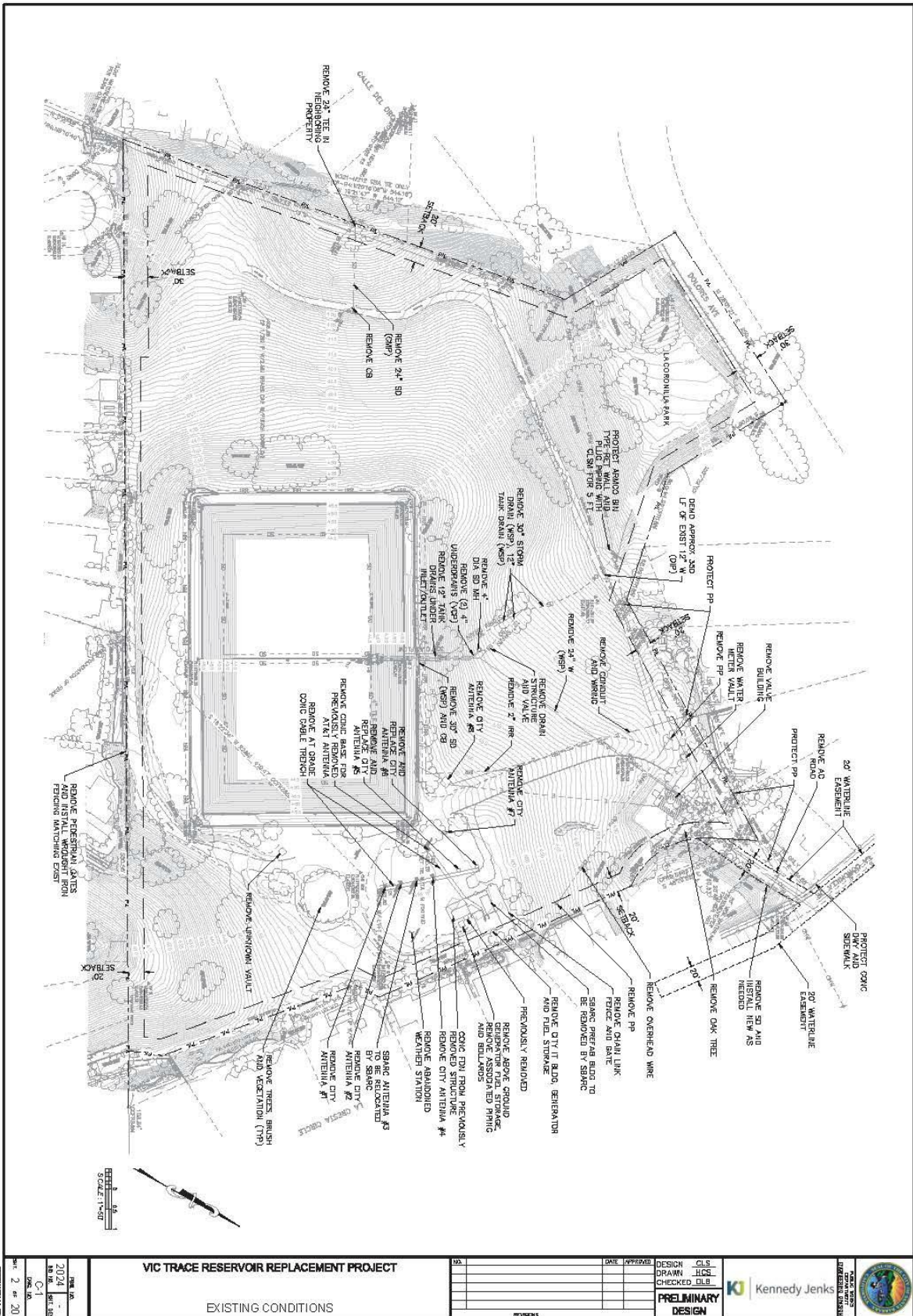

<b>VIC TRACE RESERVOIR REPLACEMENT PROJECT</b> EXISTING CONDITIONS		DATE: _____ APPROVED: _____	DESIGN: CJS CHECKED: HCH DRAWN: DLB		
PRELIMINARY DESIGN		DATE: _____ APPROVED: _____	DESIGN: CJS CHECKED: HCH DRAWN: DLB		



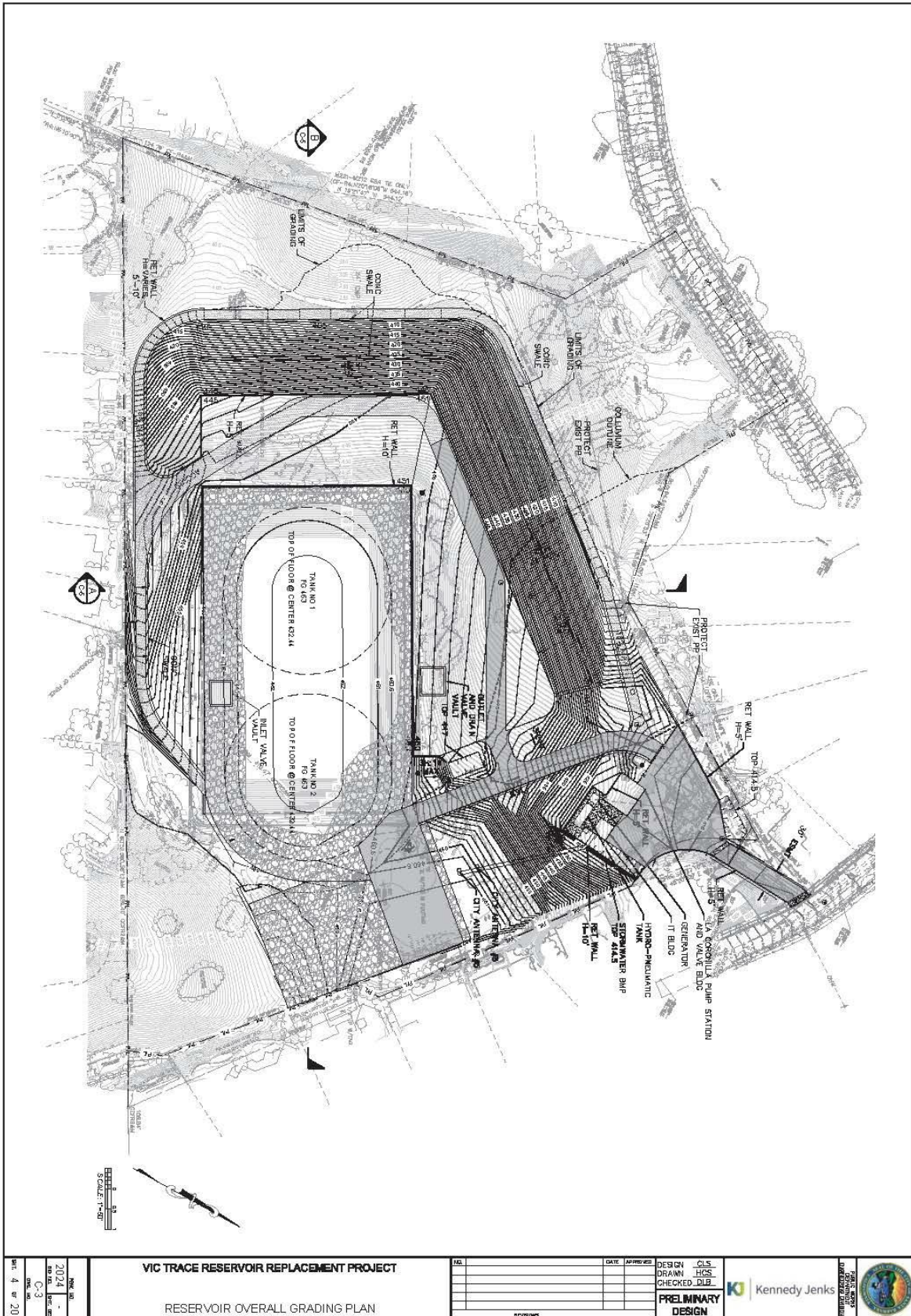

DATE	2025
BY	PCD
CHECKED	DLB
SCALE	1" = 50'
SHEET NO.	4 OF 20

**VIC TRACE RESERVOIR REPLACEMENT PROJECT**

RESERVOIR OVERALL GRADING PLAN

NO.	DATE	APPROVED

DESIGN: CJS  
 DRAWN: HCS  
 CHECKED: DLB  
**PRELIMINARY DESIGN**

Kennedy Jenks



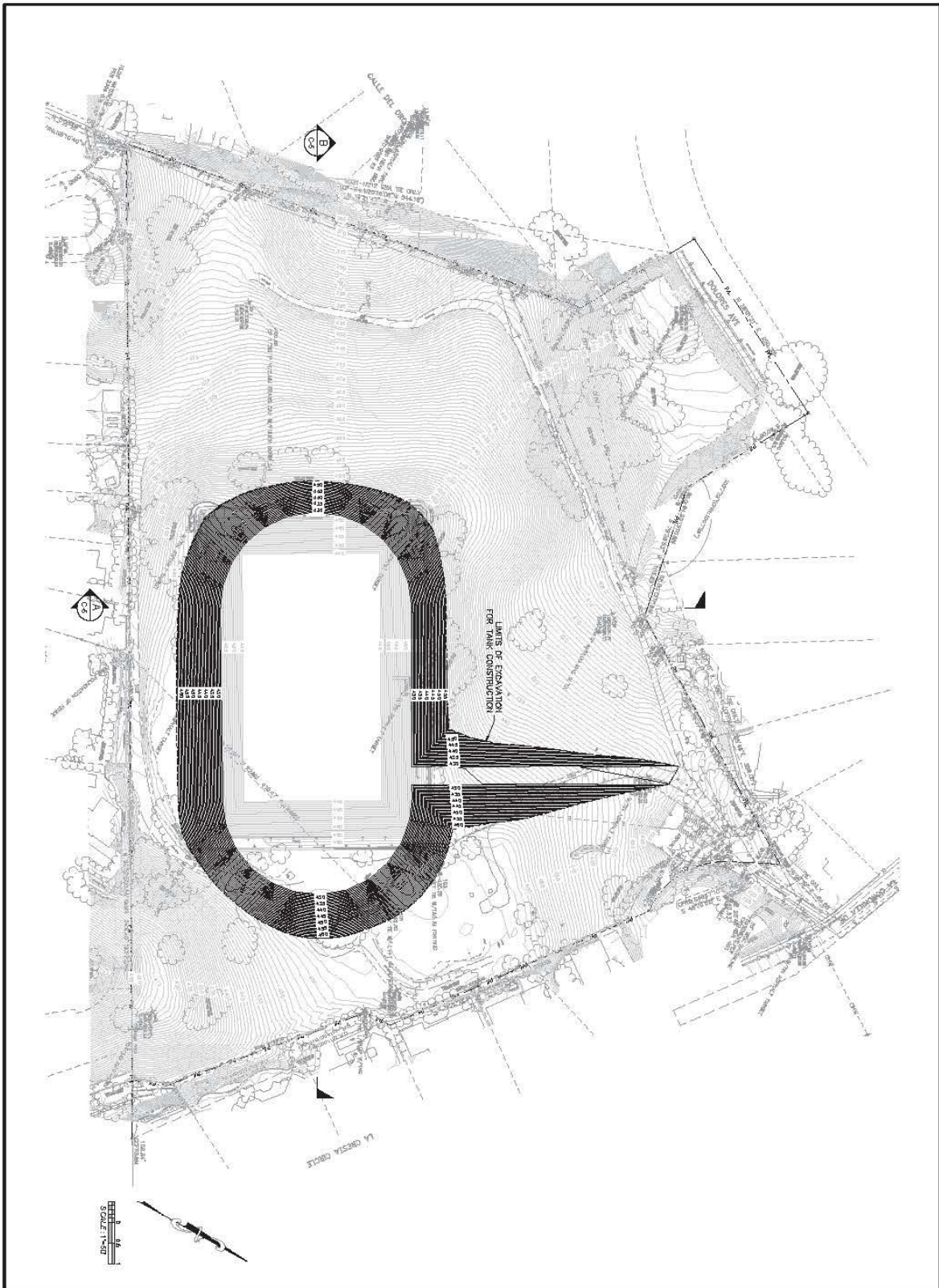

VIC TRACE RESERVOIR REPLACEMENT PROJECT TEMPORARY CONSTRUCTION EXCAVATION AND GRADING PLAN	DATE: _____ APPROVED: _____	DESIGN: CLS DRAWN: HCS CHECKED: DLB	Kennedy Jenks	
	REVISIONS: _____	PRELIMINARY DESIGN		

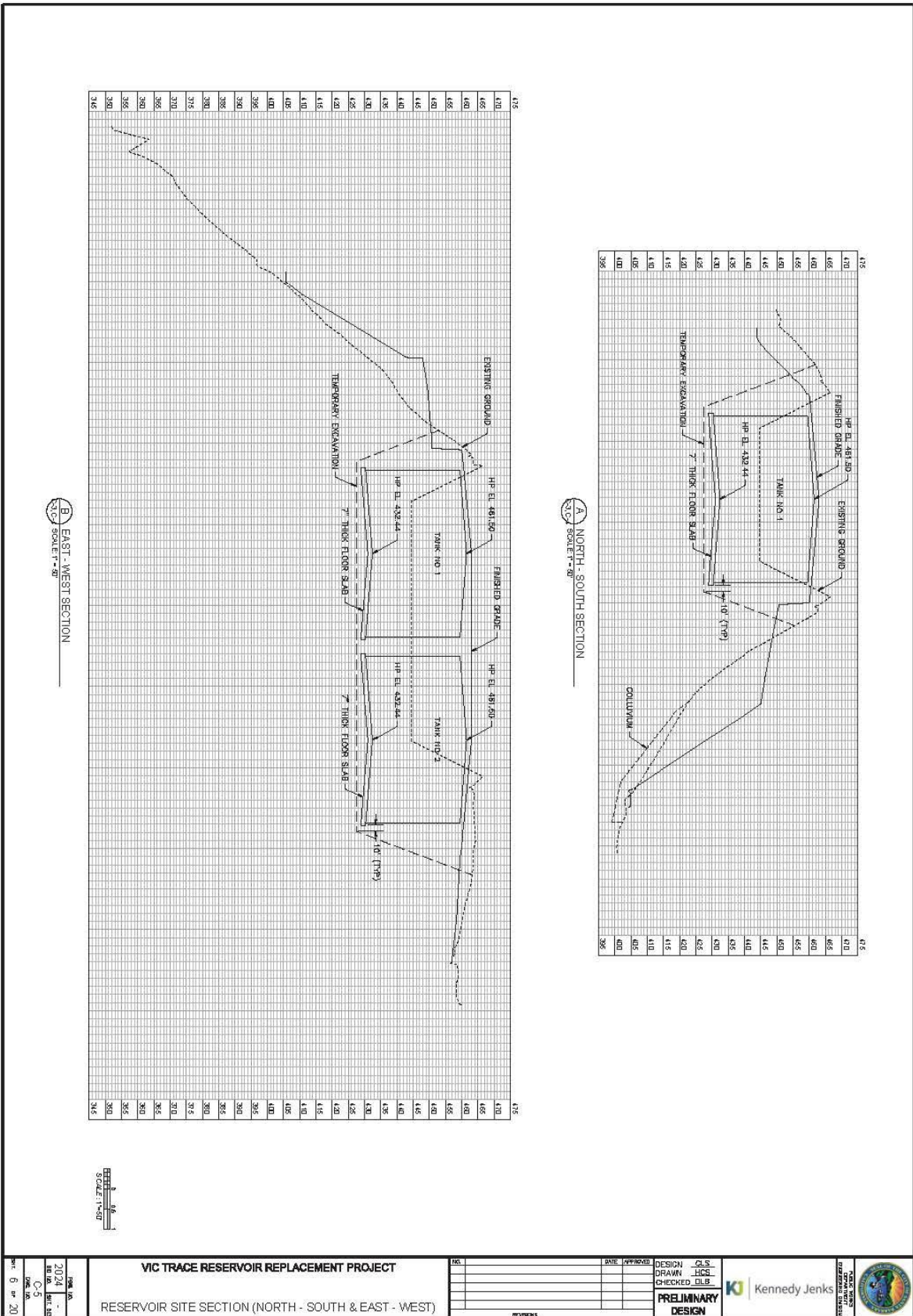

<b>VIC TRACE RESERVOIR REPLACEMENT PROJECT</b> RESERVOIR SITE SECTION (NORTH - SOUTH & EAST - WEST)		DATE: _____ APPROVED: _____	DESIGN: CJS DRAWN: HJS CHECKED: DLB <b>PRELIMINARY DESIGN</b>		
SHEET NO. 2024 OF 5 DATE: 6/20/20	PROJECT NO. 2024-05	REVISIONS:	DESIGN: CJS DRAWN: HJS CHECKED: DLB <b>PRELIMINARY DESIGN</b>	Kennedy Jenks	



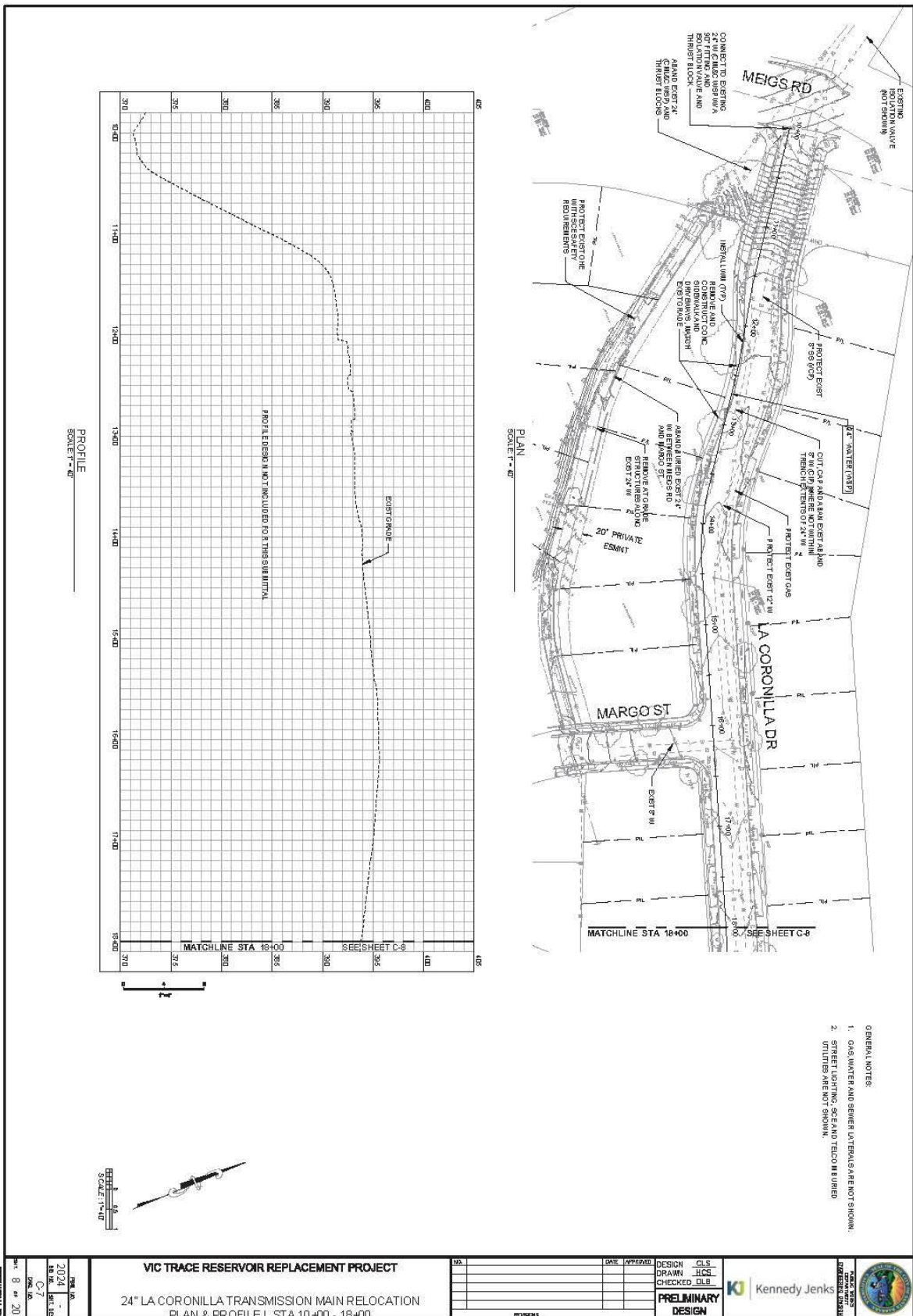

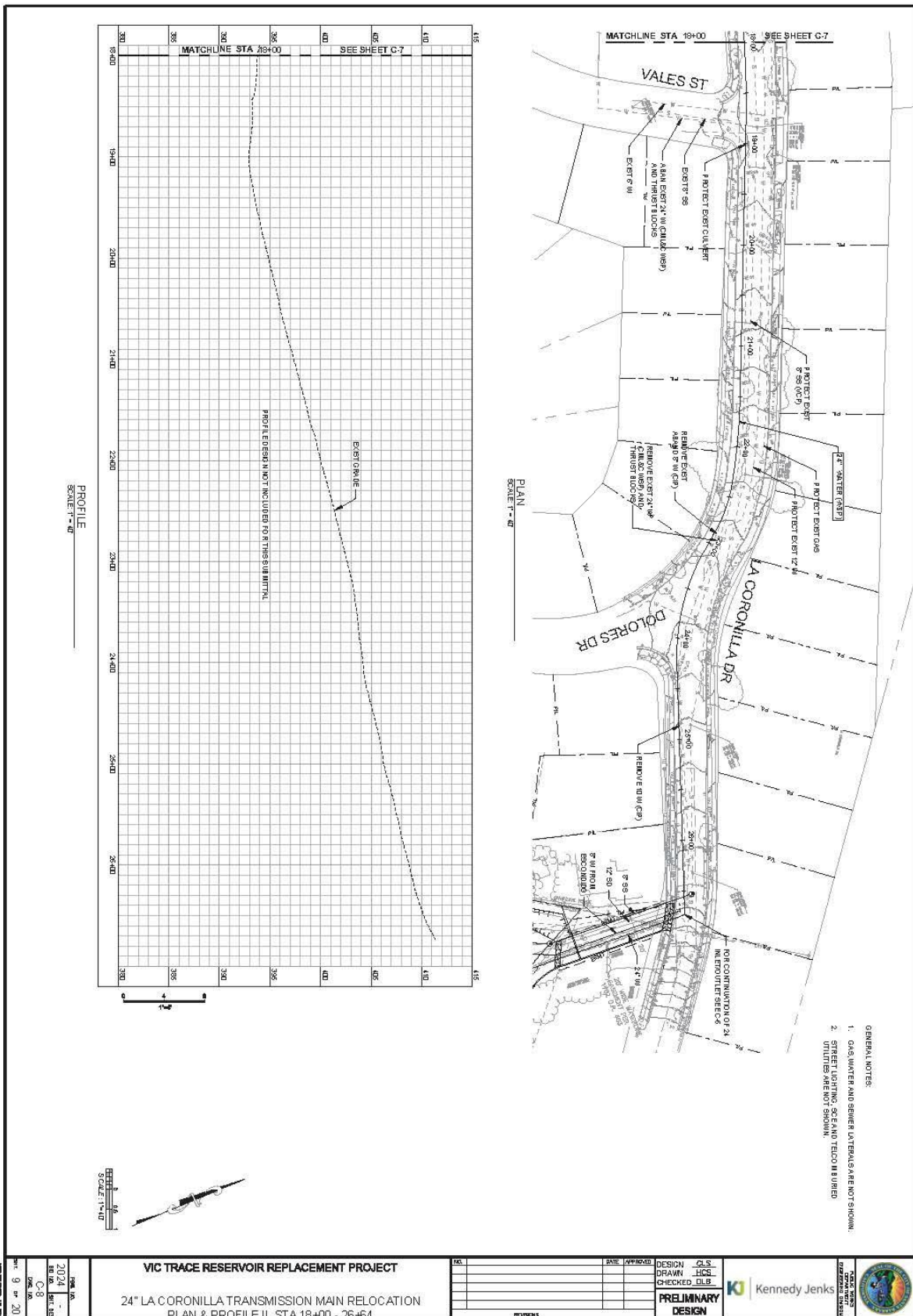

TITLE BLOCK <b>VIC TRACE RESERVOIR REPLACEMENT PROJECT</b> 24" LA CORONILLA TRANSMISSION MAIN RELOCATION PLAN & PROFILE II STA 18+00 - 26+64	REVISIONS NO.   DATE   APPROVED   DESCRIPTION	DESIGN   CJS DRAWN   HCS CHECKED   DLB	Kennedy Jenks 	
		PRELIMINARY DESIGN		
DATE: 2024 DESIGNED BY: CJS DRAWN BY: HCS CHECKED BY: DLB SCALE: 1"=40' 9th Mar 2025	PROJECT NO.: 2024-08 SHEET NO.: 18 OF 18			









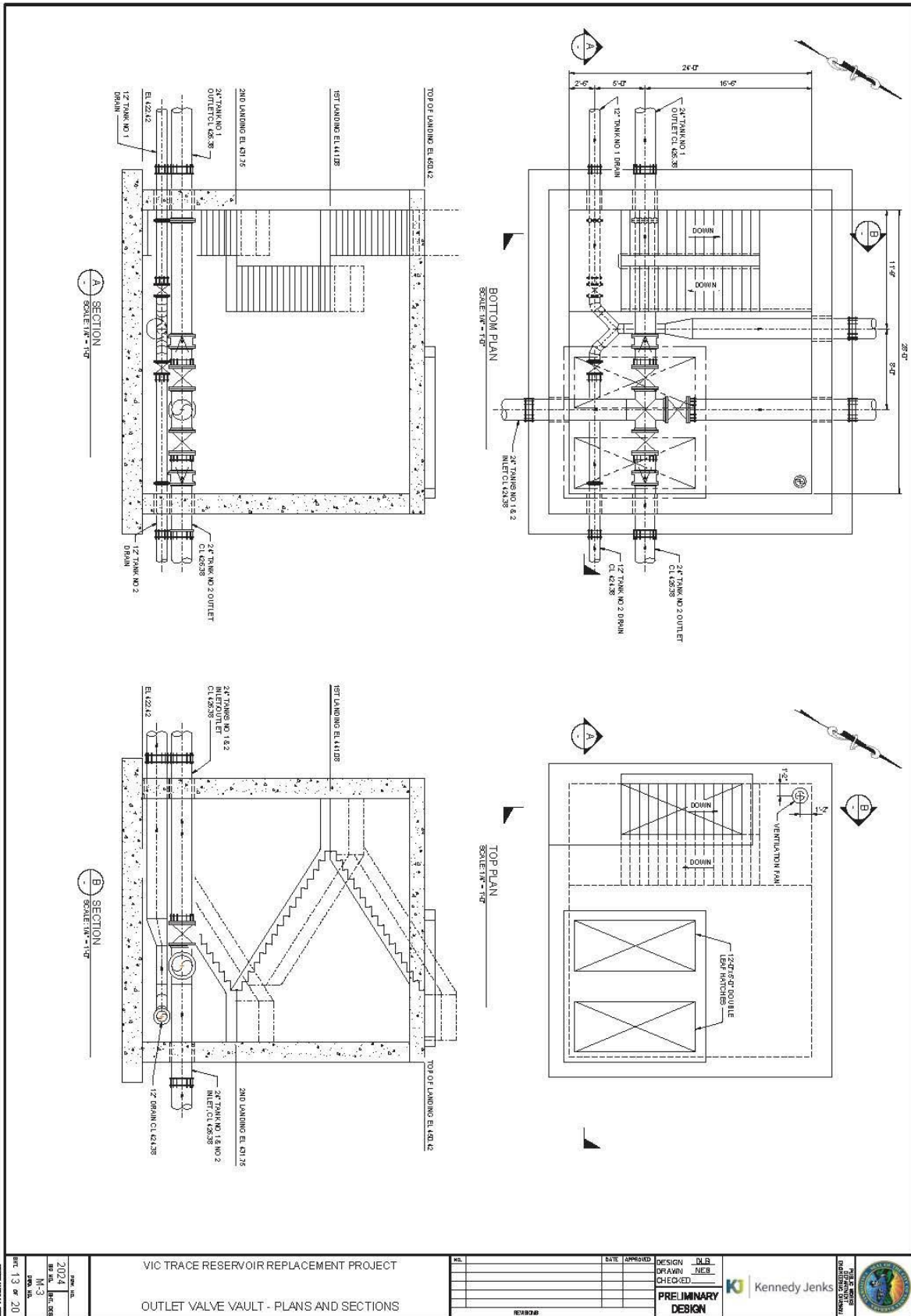

VIC TRACE RESERVOIR REPLACEMENT PROJECT  OUTLET VALVE VAULT - PLANS AND SECTIONS	NO. _____ DATE _____	DESIGN DRAWN CHECKED PRELIMINARY DESIGN	D.B. N.E.B. N.E.B.	Kennedy Jenks 
	2024 10-3 10-3	DATE APPROVED _____ APPROVED _____	DATE _____ DRAWN _____ CHECKED _____	

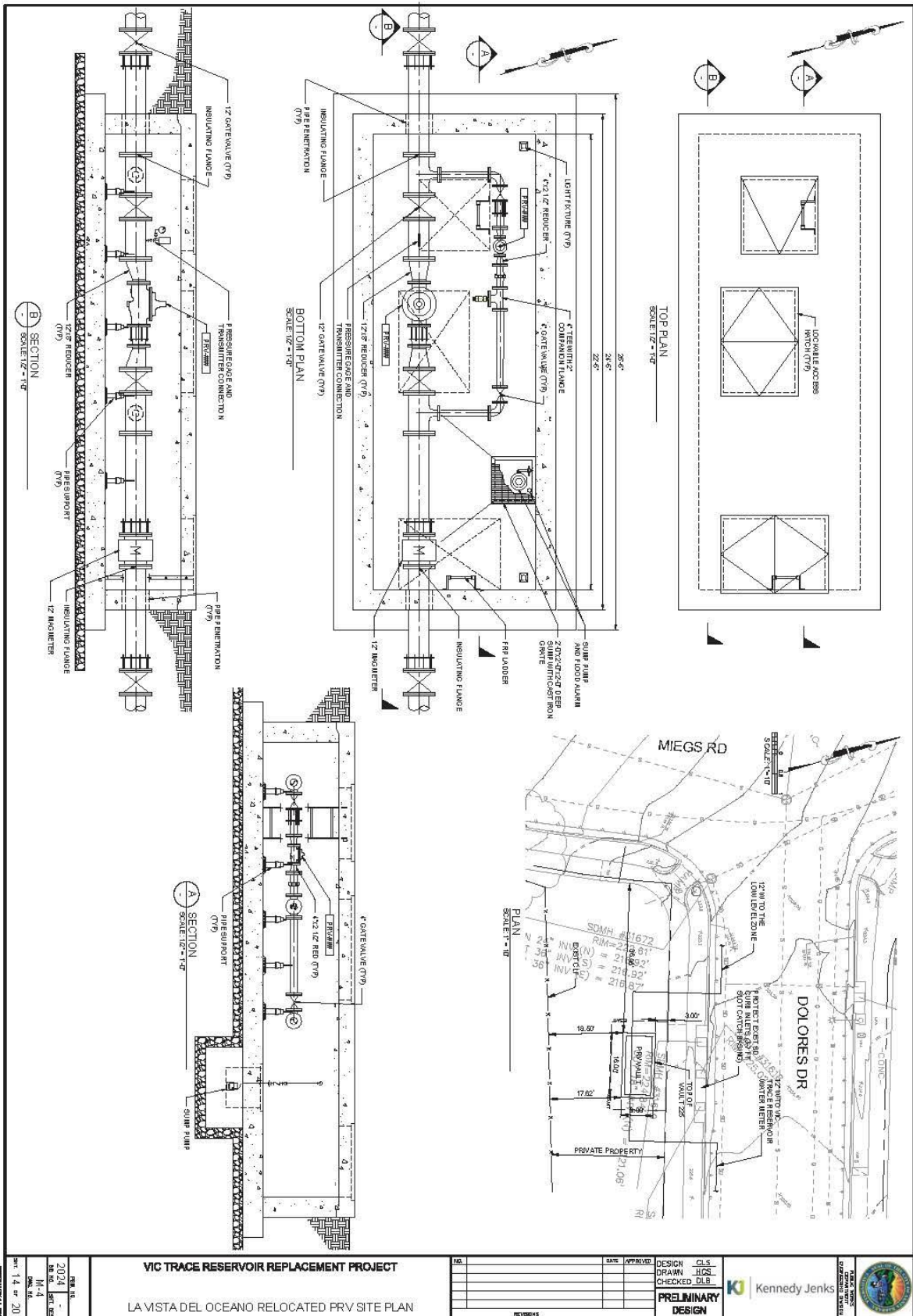





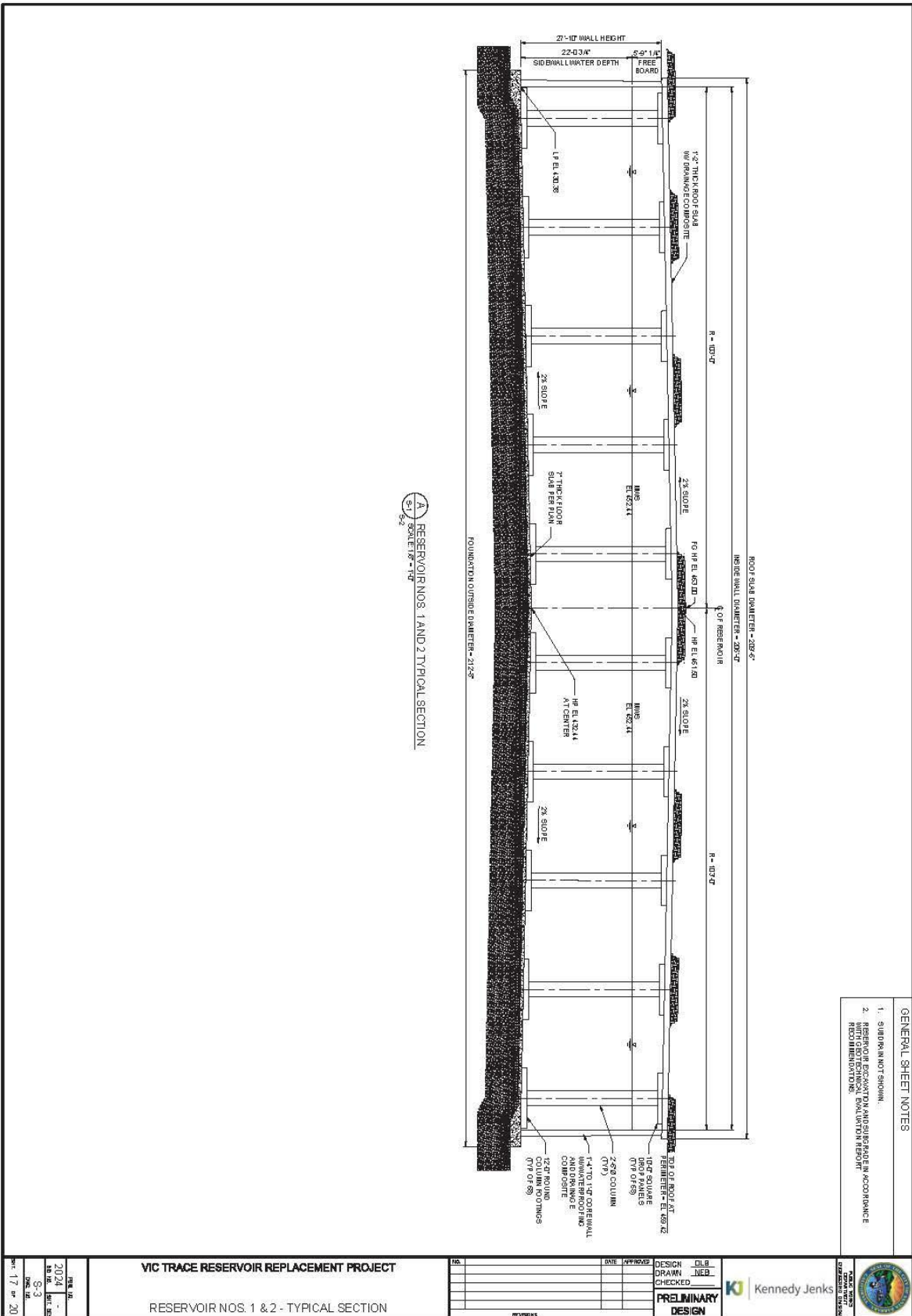



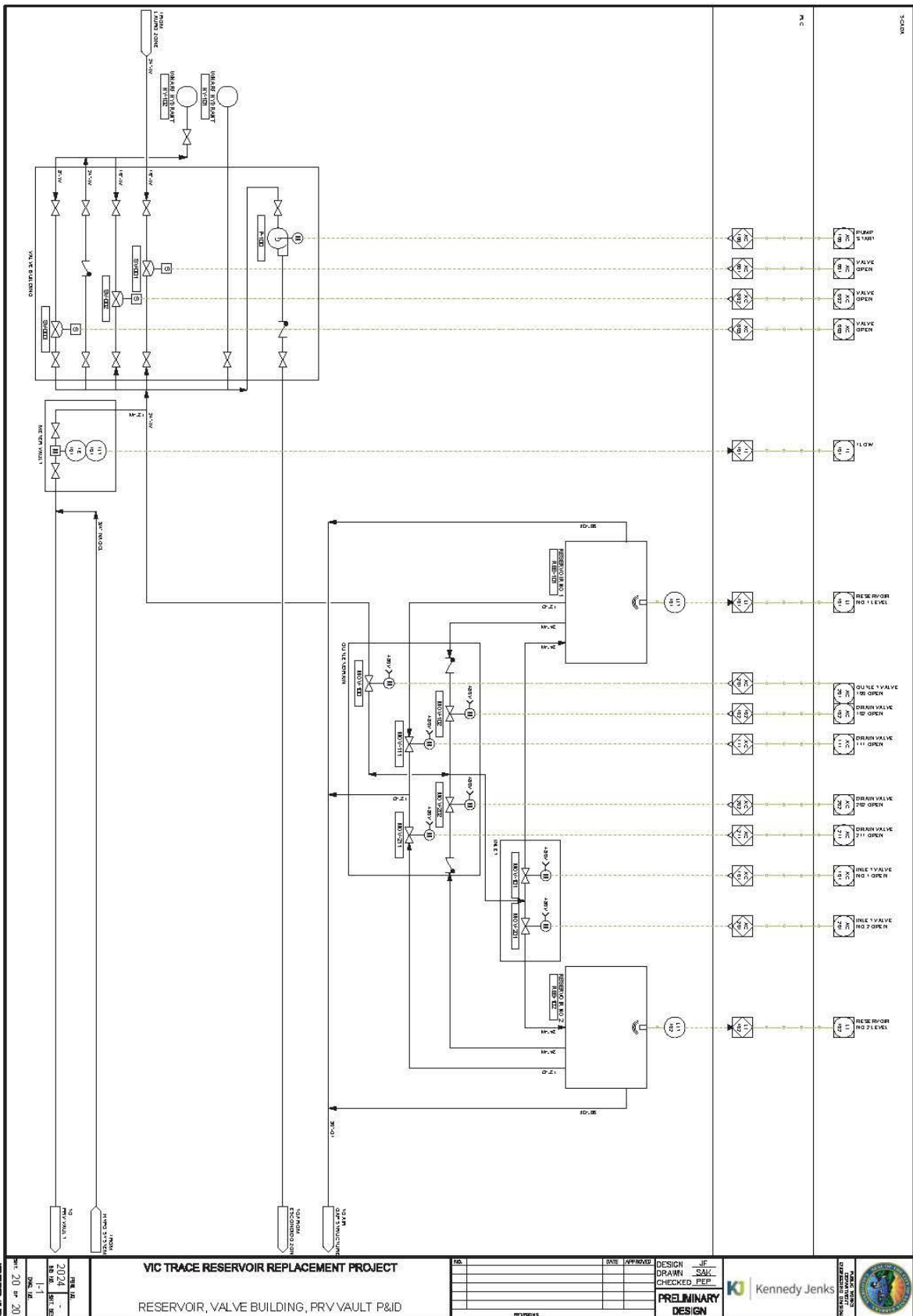

VIC TRACE RESERVOIR REPLACEMENT PROJECT RESERVOIR, VALVE BUILDING, PRV VAULT P&ID	DATE: 2/20/25 APPROVED: [Signature]	DESIGN: [Signature] DRAWN: [Signature] CHECKED: [Signature]	
	REVISIONS:	PRELIMINARY DESIGN	