

# Title 25: Objective Design and Development Standards

City of Santa Barbara  
Proposed for Adoption  
October 17, 2024  
Adopted: \_\_\_\_  
City Council Resolution No. \_\_\_\_



*This page intentionally left blank*

# Table of Contents

---

<b>Chapter 25.01</b>	<b>Introduction</b>	<b>1</b>
25.01.010	Purpose	1
25.01.020	Overview	1
25.01.030	Goals	2
25.01.040	Relationship to Santa Barbara General Plan	2
25.01.050	Relationship to Local Coastal Program	4
25.01.060	Relationship to City of Santa Barbara Municipal Code	4
25.01.070	Applicability	5
25.01.080	Procedures	6
25.01.090	Zones Established	7
25.01.100	Summary of Zones	7
25.01.110	Zone Map	8
25.01.120	Architectural Styles Map	8
25.01.130	Quick Code Guide	11
<b>Chapter 25.02</b>	<b>Zones</b>	<b>13</b>
25.02.010	Purpose	13
25.02.020	Overview	13
25.02.030	General Requirements	14
25.02.040	Design Sites	15
25.02.050	Façade Zone	18
25.02.060	Neighborhood Medium (NM)	21
25.02.070	Neighborhood Large (NL)	25
25.02.080	Mixed-Use Corridor (MUC)	29
25.02.090	Downtown Edge (DE)	33
25.02.100	Downtown Core (DC)	37

<b>Chapter 25.03</b>	<b>General Site Design Standards</b>	<b>41</b>
25.03.010	Purpose	41
25.03.020	General Requirements	41
25.03.030	Habitat Buffers	42
25.03.040	Open Yards	43
25.03.050	Landscape	43
25.03.060	Lighting	45
25.03.070	Fences and Hedges	45
25.03.080	Screening	46
25.03.090	Trash Enclosures	47
25.03.100	Parking Techniques	48
25.03.110	Sloped Parcels	49
25.03.120	Retaining Walls	53
25.03.130	Privacy	54
25.03.140	Rooftop Decks	55
25.03.150	Ground Surfaces and Paving	56
25.03.160	Large Site Standards	57
<b>Chapter 25.04</b>	<b>Building Types</b>	<b>63</b>
25.04.010	Purpose	63
25.04.020	Overview	63
25.04.030	General Requirements	65
25.04.040	Allowed Building Types	67
25.04.050	Duplex Side-by-Side	68
25.04.060	Duplex Stacked	70
25.04.070	Cottage Court	72
25.04.080	Medium Multiplex	74
25.04.090	Duplex Court	76
25.04.100	Side Court	78
25.04.110	Medium Courtyard	80
25.04.120	Large Multiplex	82
25.04.130	Large Courtyard	84
25.04.140	Downtown Building	86
25.04.150	Massing Types	88
25.04.160	Massing and Façade Composition	91
25.04.170	Adjacency and Height Standards	98

<b>Chapter 25.05</b>	<b>Frontages</b>	<b>101</b>
25.05.010	Purpose	101
25.05.020	General Requirements	101
25.05.030	Allowed Frontage Types	103
25.05.040	Porch Projecting	104
25.05.050	Porch Recessed	106
25.05.060	Dooryard	108
25.05.070	Stoop	110
25.05.080	Forecourt	112
25.05.090	Maker Shopfront	114
25.05.100	Shopfront	116
25.05.110	Terrace	118
25.05.120	Gateway	120
25.05.130	Arcade	122
<b>Chapter 25.06</b>	<b>Architectural Design</b>	<b>125</b>
25.06.010	Purpose	125
25.06.020	General Requirements	125
25.06.030	Quick Code Guide: Architectural Design Standards	127
25.06.040	Craftsman Style Group	128
25.06.050	Mediterranean Style Group	144
25.06.060	Contemporary Style Group	162
<b>Chapter 25.07</b>	<b>Exceptions</b>	<b>179</b>
25.07.010	Purpose	179
25.07.020	Exceptions to Standards	179
<b>Chapter 25.08</b>	<b>Definitions</b>	<b>191</b>
25.08.010	Purpose	191
25.08.020	Definitions	191

*This page intentionally left blank*

# Chapter 25.01 Introduction

---

## Sections:

25.01.010	Purpose
25.01.020	Overview
25.01.030	Goals
25.01.040	Relationship to Santa Barbara General Plan
25.01.050	Relationship to Local Coastal Program
25.01.060	Relationship to City of Santa Barbara Municipal Code
25.01.070	Applicability
25.01.080	Procedures
25.01.090	Zones Established
25.01.100	Summary of Zones
25.01.110	Zone Map
25.01.120	Architectural Styles Map
25.01.130	Quick Code Guide

---

## 25.01.010 Purpose

The purpose of this Title, also referred to as the Objective Design and Development Standards (ODDS), is to provide clear, objective, and measurable standards for multi-unit and mixed-use residential development within the zones established in Chapter 25.02 (Zones).

---

## 25.01.020 Overview

The ODDS regulate the desired physical form and character of new multi-unit housing projects to encourage a diversity of pedestrian-oriented housing types within walkable neighborhoods. Pedestrian orientation refers to design qualities and features that contribute to an active, inviting, and pleasant place for pedestrians that typically include most of the following elements:

- A. Highly-articulated building façades at street level, located directly behind the sidewalk.
- B. Visibility into buildings at street level.
- C. A continuous sidewalk, with minimum intrusions into pedestrian right-of-way.
- D. Continuity of building façades along the right-of-way with few interruptions in the progression of buildings.
- E. Design amenities at the street level such as awning, paseos, arcades, landscape, and street furniture.

The ODDS regulations address the relationship between buildings and the public realm, the context of buildings in their neighborhoods, and development of new street networks on larger sites. The ODDS promotes desirable development patterns by regulating building size, placement, frontages, and architectural style. The ODDS are offered as an alternative path for planning entitlements to replace subjective guidelines with predictable and objective standards.

---

## 25.01.030 Goals

- A. **Increase Predictability** and confidence in the City review process with consistent expectations for desirable results.
- B. **Promote a Livable City** by supporting diverse housing types that engage the streetscape to create a vibrant and walkable community.
- C. **Respect the Context** of Santa Barbara's existing built and natural environment with buildings and design that reflect the City's vision of exemplary architecture.
- D. **Create a Visual Language** to better communicate local standards with photographs, illustrations, maps, and tables in a catalog of agreed-upon designs.

---

## 25.01.040 Relationship to Santa Barbara General Plan

The ODDS implements the City's General Plan principles for development, which encourage sustainable land use and circulation patterns.

- A. **Focus growth** to encourage housing with easy access to transit and commercial services and providing incentives to develop affordable housing.
- B. **Encourage a mix of land uses** to include strong retail and workplace centers with easy access to commercial services and recreation, connectivity and civic engagement, and public space for pedestrians.
- C. **Strengthen mobility options and promote active, healthy living** by linking mixed-use development with transit; encouraging compact, vibrant, walkable places; encouraging the use of bicycles; and reducing the need for parking.

The General Plan establishes residential densities (dwelling units per acre) for applicable land use designations, including parcels that can use the ODDS. The ODDS have been prepared to conform with the General Plan land use designations and to correlate with the City's Average Unit Size Density Incentive Program as the City's foremost multi-unit housing program to implement the General Plan goals. Applicants are responsible for complying with residential densities in the General Plan through choice of unit sizes, building footprint/massing, and building types. Table 25.01.040 A (General Plan Land Use Designations Correlated to ODDS Zones) shows how the existing General Plan land use designations correspond to ODDS zones as described in Chapter 25.02 (Zones).



Table 25.01.040.A: General Plan Land Use Designations Correlated to ODDS Zones						
Land Use Designation	Max. Density	ODDS Zones				
		Neighborhood Medium	Neighborhood Large	Mixed-Use Corridor	Downtown Edge	Downtown Core
<b>Low Density Residential</b>	<b>2-3 du/acre</b>					
Low Density Residential		X				
<b>Medium Density Residential</b>	<b>12 du/acre</b>					
Medium Density Residential		X				
Office-Medium Density Residential		X				
<b>Medium-High Density Residential</b>	<b>27 du/acre</b>					
Medium High Density Residential		X	X	X	X	X
Office-Medium High Density Residential			X	X		
Commercial-Medium High Density Residential			X	X	X	X
Commercial Industrial-Medium High Density Residential			X	X	X	
<b>High Density Residential</b>	<b>36 du/acre</b>					
High Density Residential			X			
Office-High Density Residential			X		X	
Commercial-High Density Residential			X	X	X	X
<b>Priority Housing Overlay</b>	<b>63 du/acre</b>					
Priority Housing Overlay <sup>1</sup>			X	X	X	X

Lots with more than one Land Use Designation: Apply the applicable ODDS Zone following the Land Use Designation boundaries.

<sup>1</sup> Parcels with Priority Housing Overlay have an underlying Land Use Designation.

## 25.01.050 Relationship to Local Coastal Program

The Local Coastal Program establishes residential densities (dwelling units per acre) for applicable land use designations for parcels in the Coastal Zone that can use the ODDS. Applicants for projects in the Coastal Zone are responsible for complying with Coastal Land Use Plan residential densities through choice of unit sizes, building footprint/massing, and building types. Development in the Coastal Zone shall require approval of a Coastal Development Permit consistent with the requirements of the Coastal Land Use Plan policies, including protection of coastal resources. Table 25.01.050.A (Local Coastal Program Land Use Designations Correlated to ODDS Zones) shows how existing coastal land use designations correspond to ODDS Zones.

Table 25.01.050.A: Local Coastal Program Land Use Designations Correlated to ODDS Zones						
Land Use Designation	Max. Density	ODDS Zones				
		Neighborhood Medium	Neighborhood Large	Mixed-Use Corridor	Downtown Edge	Downtown Core
<b>Medium Density Residential</b>	<b>12 du/acre</b>					
Medium Density Residential		X				
<b>Medium-High Density Residential</b>	<b>27 du/acre</b>					
Medium High Density Residential		X	X			
Hotel & Residential			X			
Coastal-Oriented Commercial/Medium High Residential				X		
Hotel & Related Commerce II/Medium High Residential				X		
Coastal-Oriented Commercial/Hotel & Related Commerce II				X		
Commercial/Medium High Residential			X	X		

Lots with more than one Land Use Designation: Apply the applicable ODDS Zone following the Land Use Designation boundaries.

## 25.01.060 Relationship to City of Santa Barbara Municipal Code

The ODDS work in conjunction with the entire Santa Barbara Municipal Code to implement State law that requires "applicable, objective general plan, zoning, and subdivision standards and criteria, including design review standards" per the Housing Crisis Act of 2019 (*Senate Bill 330*).

The ODDS provide most of the development standards for housing development projects in Title 25, except that subdivision standards in *Title 27 (Subdivisions)* apply and land use continues to be regulated by *Title 28 (Zoning-Coastal)* and *Title 30 (Zoning-Inland)*. Where Title 25 is silent, the rest of the Municipal Code prevails. Where a conflict exists between the standards in Title 25 and *Title 28 (Zoning-Coastal)* and *Title 30 (Zoning-Inland)*, Title 25 shall prevail.

Table 25.01.060.A (Base Zones Correlated to ODDS Zones) shows how the ODDS corresponds to the existing Title 30 Base Zones.

Projects in the Coastal Zone will rely on certain portions of *Title 28 (Zoning-Coastal)* that remain in effect or are not included in Title 25 until *Title 30 (Zoning-Inland)* is certified as a Local Coastal Program Amendment by the California Coastal Commission.

Base Zones <sup>1</sup>	ODDS Zones				
	Neighborhood Medium	Neighborhood Large	Mixed-Use Corridor	Downtown Edge	Downtown Core
<b>Residential</b>					
R-2 (Two-Unit Residential)	X				
R-M (Residential Multi-Unit)		X	X		
R-MH (Residential Multi-Unit and Hotel)		X			
<b>Nonresidential</b>					
O-R (Office Restricted)		X	X	X	
C-R (Commercial Restricted)		X	X		
C-G (Commercial General)		X	X	X	X
M-C (Manufacturing Commercial)		X	X	X	X
CO-HV (Coastal-Oriented Hotel and Visitor-Serving)		X	X		
CO-CAR (Coastal-Oriented Commercial, Arts, and Recreation)			X		

Lots with more than one Base Zone: Apply the applicable ODDS Zone following the Base Zone boundaries.

<sup>1</sup> All Base Zones listed are Inland Zones. See *Section 30.05.010 (Zones Established)* for Coastal Zone equivalencies.

## 25.01.070 Applicability

- A. **Rules for Construction of Language.** The rules for construction of language in *Chapter 30.10 (Rules for Construction of Language)* apply to the text of the ODDS.
- B. **Standards.** The applicable standards of the ODDS apply so as to not require stating the phrase "and all applicable standards" throughout the ODDS.
- C. **Applicability.** ODDS applies to qualifying residential projects for which the State requires review for compliance using only objective standards, including Housing Development Projects meeting the definition of *Government Code § 65589.5(h)(2)*.
  1. Applicants may opt out of using ODDS for a project, including those projects that qualify under State law for objective review, however, the project will then proceed under the City's discretionary review process as outlined in *Chapter 30.205 (Common Procedures)* which voluntarily takes a project outside of the Housing Accountability Act provisions.
  2. Development standard waivers, concessions, or incentives granted pursuant to State Density Bonus Law (*Government Code § 65915*) and administrative exceptions allowed in Chapter 25.07 (Exceptions) of this code are allowed. No other exception to ODDS through a discretionary variance, modification, exception, waiver, or other discretionary approval is allowed.

- D. **New Construction.** The ODDS is only applicable for new construction, not additions, expansions, alterations, or remodels. The ODDS shall not be used to add new buildings to sites with existing buildings to remain except as provided below.
  - 1. The ODDS may be used to add a Cottage Court, Duplex Court, or Side Court building type on a site with an existing single-unit or two-unit residential building provided the development is consistent with density standards in Subsection 25.02.030.D (Density). The existing building is not required to comply with the ODDS standards unless exterior alterations are proposed.
- E. **Reference Illustrations.** Images, figures, diagrams, and graphics are intended to provide a reference and are illustrative, not regulatory. They are not an exhaustive representation of applicable standards. In case of conflict between the text and a diagram or graphic, the text controls.
- F. **Definitions.** See Chapter 25.08 (Definitions) for definitions of specialized terms used within the ODDS. All other terms are defined in *Chapter 30.300 (Definitions)*.

---

## 25.01.080 Procedures

Applications for development are to be processed in compliance with the City's common procedures for reviewing all applications and processing permits and approvals identified in *Chapter 30.205 (Common Procedures)*, consistent with State law, and the following:

- A. **Administrative Relief.** Requests for administrative relief from certain standards in the ODDS are to be processed in compliance with the procedures and the required findings in Section 25.07.020 (Exceptions to Standards).
- B. **Affordable Housing Streamlined Approval (Senate Bill 35).** Streamlined affordable housing projects as defined in *Government Code § 65913.4* must select the Affordable Housing Streamlined Approval review process per *Section 30.145.035 (Affordable Housing Streamlined Approval)* at the time of initial application submittal.
- C. **Housing Development Projects (Senate Bill 330).** Housing Development Projects as defined in *Government Code § 65589.5(h)(2)* must select Objective Design Review process per Section 30.220.050 (Objective Design Review) at the time of initial application submittal.
- D. **Exempt from Concept Review.** Qualifying multi-unit housing development projects in compliance with the ODDS and constructed in accordance with the Average Unit-Size Density Incentive Program, are exempt from mandatory Pre-Application and Concept Review pursuant to *Section 30.150.060 (Pre-Application and Concept Review Required)*.
- E. **Amendments.** All proposals to change the text of this Title or revise a zone or zoning boundary line shown on the Zone Map or architectural styles boundary as shown on the Architectural Styles Map must be made pursuant to a Zoning Amendment as described in *Chapter 30.235 (General Plan and Zoning Amendments)*.

---

### 25.01.090 Zones Established

This Section identifies the zones, based on the intended physical form and character of the environments described in the ODDS. These zones focus on multi-unit residential and mixed-use environments and range in function and intensity from primarily residential areas (Neighborhood Medium and Neighborhood Large) to moderate-intensity centers (Mixed-Use Corridor), to higher intensity neighborhoods (Downtown Edge) and the highest intensity center (Downtown Core). The terminology reflects the intended physical form and hierarchy of different places. These zones are for the purpose of generating and supporting a variety of housing types and the physical character of existing and new walkable environments.

To reflect historic development patterns in the City of Santa Barbara, and to allow greater use of the ODDS on a wider variety of lots, the ODDS Zones build upon each other in building intensities by allowing small-to-medium footprint house-scale building types in all zones. To retain and create vibrant urban centers, certain portions of the Downtown Core along State Street requires ground floor nonresidential space.

---

### 25.01.100 Summary of Zones

The ODDS implements Santa Barbara's General Plan vision and policies through a palette of zones described in Chapter 25.02 (Zones), coupled with building type choices, site planning, development standards, and architectural styles. These zones are applicable to residential and mixed-use projects of two or more units and consist of objective standards to facilitate development on those parcels.

- A. Within the Downtown Core (DC) and Downtown Edge (DE) Zones, the ODDS:
  - 1. Provides for large footprint, high-intensity, residential mixed-use buildings within easy access to all modes of travel; and
  - 2. Facilitates transitions from the highest residential density and mixed-use areas to the adjacent nonresidential, mixed-use, and residential neighborhoods.
- B. Within the Mixed-Use Corridor (MUC) Zone, the ODDS:
  - 1. Supports medium-to-large footprint buildings with moderate intensity residential or mixed-use buildings along arterial streets; and
  - 2. Provides infill residential development within a safe, comfortable walking distance of services and amenities.
- C. Within the Neighborhood Large (NL) and Neighborhood Medium (NM) Zones, the ODDS:
  - 1. Promotes small-to-medium footprint buildings with low-to-moderate intensity residential with limited neighborhood-serving mixed-use; and
  - 2. Builds upon the existing character of Santa Barbara's walkable neighborhoods with a range of multi-unit or clustered housing types that are compatible in scale with single-unit or transitional neighborhoods.

---

## 25.01.110 Zone Map

- A. **Zone Map.** The zones established in this Section are mapped on the ODDS Zone Map (ODDS-ZM).
- B. **Zoning District Boundaries.** The boundaries of the ODDS zoning districts shall be shown on the ODDS-ZM as applicable. In the event a housing development project is proposed on a site without an assigned ODDS Zone (e.g., annexation, rezone, etc.), the ODDS Zone is assigned based on the General Plan Land Use Designation. Low Density Residential and Medium Density Residential Land Use Designations are assigned the Neighborhood Medium ODDS Zone. Medium-High Density Residential and High Density Residential Land Use Designations are assigned the Neighborhood Large ODDS Zone. Sites with more than one Land Use Designation shall apply the applicable ODDS Zone following the Land Use Designation boundaries.

---

## 25.01.120 Architectural Styles Map

- A. **Architectural Styles Map.** The architectural style groups established in Chapter 25.06 (Architectural Design) are mapped on the Architectural Styles Map (ODDS-ASM). The ODDS-ASM map designates areas that allow the Mediterranean style group, Mediterranean and Craftsman style groups, or Mediterranean, Craftsman, and Contemporary style groups.
- B. **Architectural Styles Map Boundaries.** The boundaries of the ODDS architectural style districts shall be shown on the ODDS-ASM as applicable. In the event a housing development project is proposed on a site without an assigned ODDS architectural style (e.g., annexation, rezone, etc.), the Mediterranean style group is assigned.

### Objective Design and Development Standards Zones

- Neighborhood Medium (NM)
- Neighborhood Large (NL)
- Mixed-Use Corridor (MUC)
- Downtown Edge (DE)
- Downtown Core (DC)

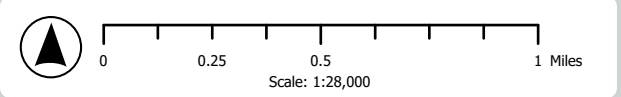
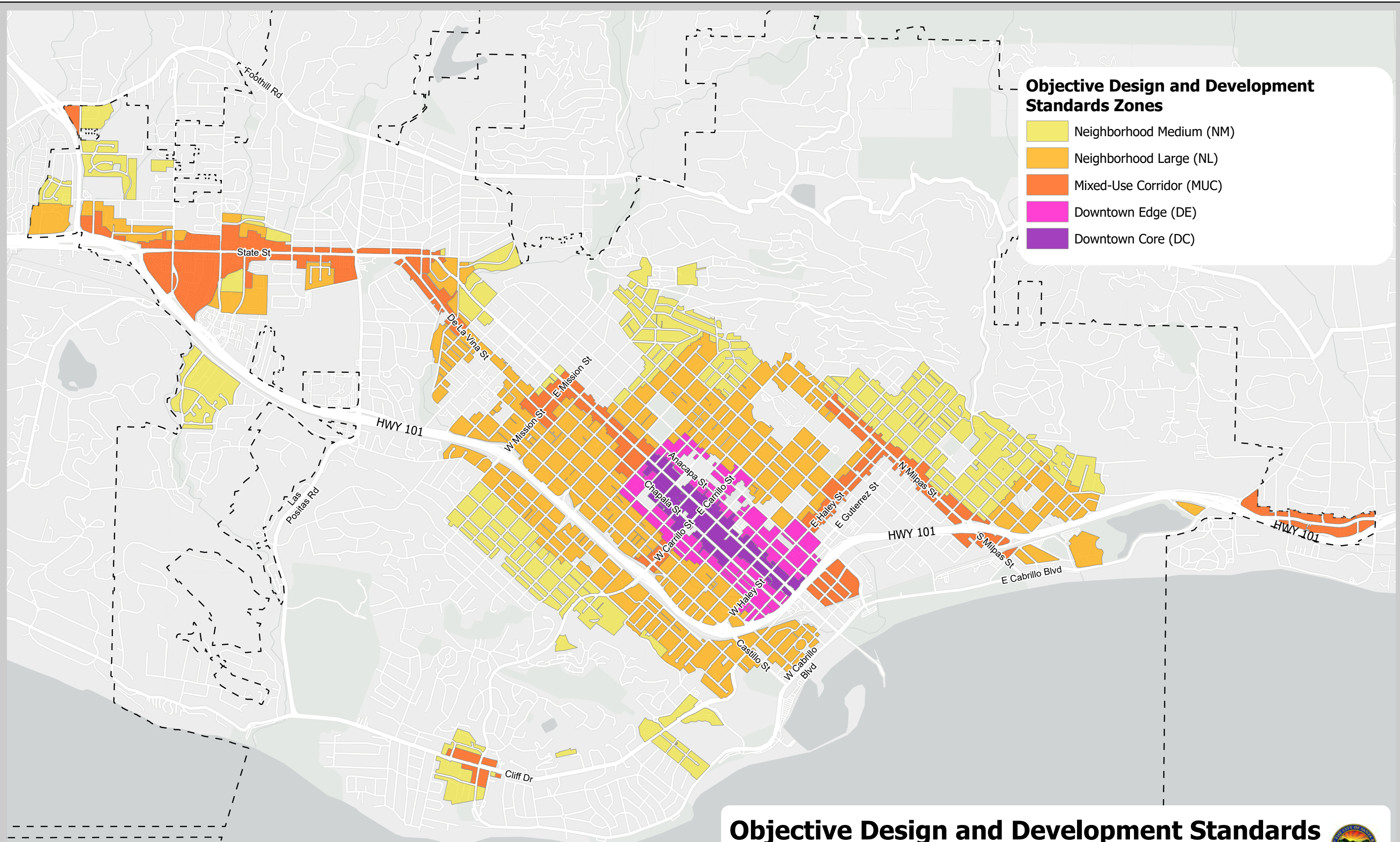

## Objective Design and Development Standards Zone Map (ODDS-ZM)



H:\Group Folders\GIS\Housing\ODS\ODS\_2023\ODS\_2023.aprx >Objective Design and Development Standards - Zones 11x17

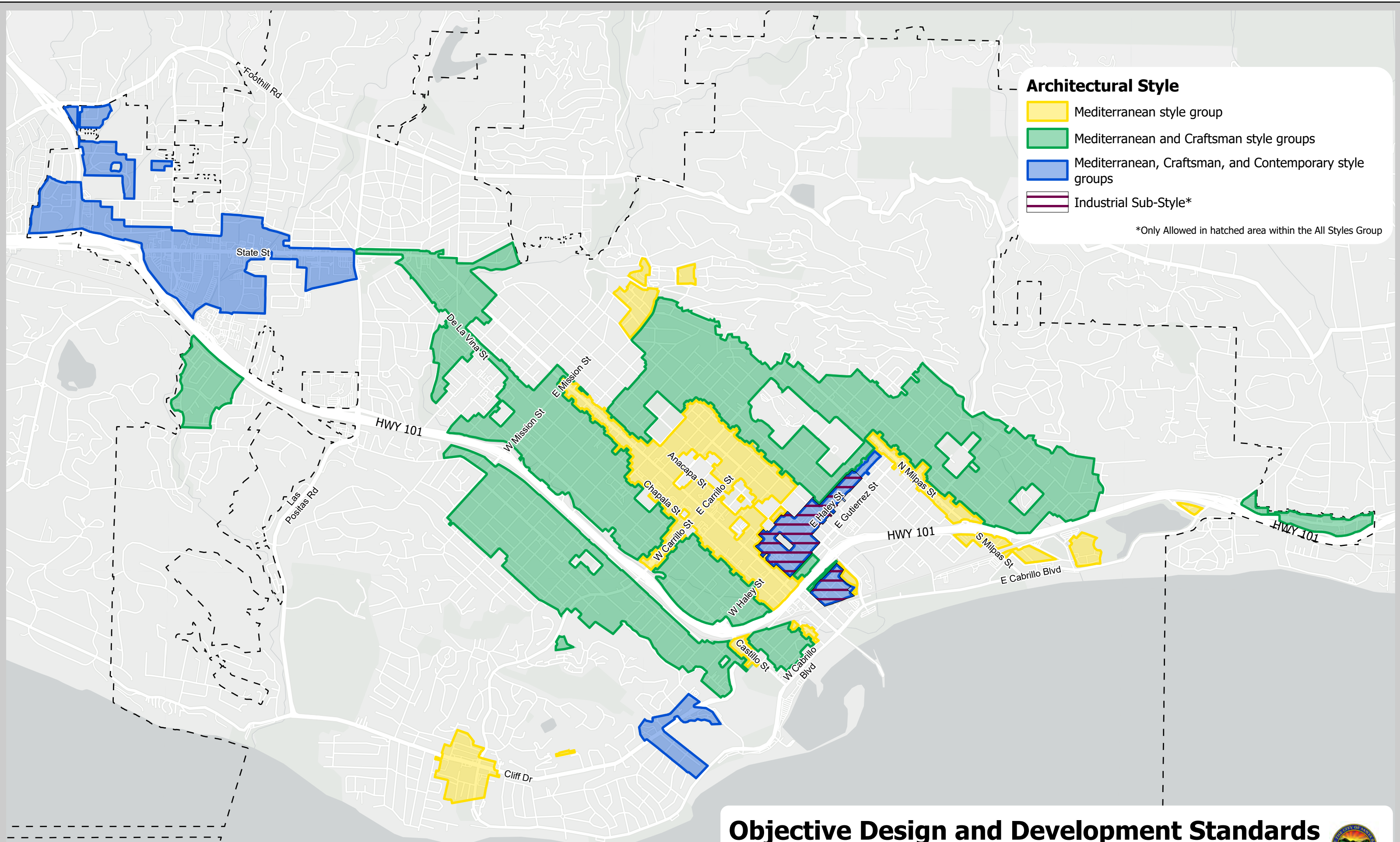

**Architectural Style**

- Mediterranean style group
- Mediterranean and Craftsman style groups
- Mediterranean, Craftsman, and Contemporary style groups
- Industrial Sub-Style\*

\*Only Allowed in hatched area within the All Styles Group

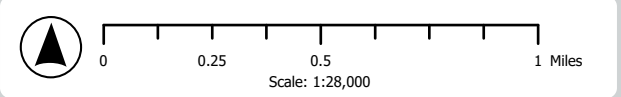

# Objective Design and Development Standards Architectural Styles Map (ODDS-ASM)





## 25.01.130 Quick Code Guide

The following is intended as a summary guide to using the ODDS. Refer to Title 30 permit procedures and application standards and ODDS forms and applications for complete guidance.

0

### Before You Begin

Identify the lot size, base zone, and, if mixed-use, verify nonresidential use is allowed in the base zone.

Identify the General Plan Land Use Designation and priority housing overlay to calculate maximum density for the site.

1

### Design Your Site

<b>Identify ODDS Zone</b>	Section 25.01.110 (Zone Map)
<b>Select Building Type and Apply Design Site Size</b>	Chapter 25.02 (Zones) Subsection B (Building Types and Design Site Size) of the Zone
<b>Apply Building Form and Placement Standards</b>	Chapter 25.02 (Zones) Subsection C (Building Form) and Subsection D (Building Placement) of the Zone  Chapter 25.04 (Building Types) Subsection C (Building Size and Massing) of the Building Type
<b>Apply Vehicle Access and Parking Standards</b>	Chapter 25.02 (Zones) Subsection E (Parking) of the Zone  Section 25.03.100 (Parking Techniques)  Chapter 25.04 (Building Types) Subsection E (Vehicle Access and Parking) of the Building Type
<b>Apply Bicycle and Pedestrian Access Standards</b>	Chapter 25.02 (Zones) Subsection E (Parking) of the Zone  Chapter 25.04 (Building Types) Subsection D (Pedestrian Access) of the Building Type
<b>Apply Open Yard Standards</b>	Section 25.03.040 (Open Yards)
<b>Apply Landscape Standards</b>	Section 25.03.050 (Landscape)

2

Designing the Building Form

**Select Massing Type and Determine Building Footprint**

Chapter 25.04 (Building Type)  
Subsection C (Building Size and Massing) of the Building Type

Section 25.04.150 (Massing Types)

**Apply Massing and Façade composition Requirements**

Section 25.04.160 (Massing and Façade Composition)

**Incorporate Adjacency and Height Standards**

Section 25.04.170 (Adjacency and Height Standards)

3

Activate the Streetscape

**Select the Frontage Type**

Chapter 25.02 (Zones)  
Subsection F (Frontages) of the Zone

**Apply Frontage Standards to Each Unit and Building Entrance**

Chapter 25.05 (Frontages)  
Subsections A-C of the Frontage

4

Apply the Architectural Style

**Select an Allowed Architectural Style**

Section 25.01.120 (Architectural Styles Map)

**Apply Standards for the Architectural Style**

Chapter 25.06 (Architectural Design)  
Subsections A-Q of the Architectural Style

5

Submit the Project

**Document Exception Request**

Chapter 25.07 (Exceptions)

**Submit a Planning Application** and supplemental checklist for objective design review

Chapter 30.205 (Common Procedures)  
Section 30.220.050 (Objective Design Review)

# Chapter 25.02 Zones

---

## Sections:

25.02.010	Purpose
25.02.020	Overview
25.02.030	General Requirements
25.02.040	Design Sites
25.02.050	Façade Zone
25.02.060	Neighborhood Medium (NM)
25.02.070	Neighborhood Large (NL)
25.02.080	Mixed-Use Corridor (MUC)
25.02.090	Downtown Edge (DE)
25.02.100	Downtown Core (DC)

---

## 25.02.010 Purpose

This Chapter establishes the palette of zones to implement the key characteristics that compromise the physical character of neighborhoods documented across Santa Barbara. The zones are for the purpose of generating and supporting the variety and physical character of existing and new pedestrian-oriented, walkable environments. These environments are described as walkable because of their interconnected streets and blocks with sidewalks, variety of housing choices, and proximity to services, shopping, and transit.

---

## 25.02.020 Overview

- A. The ODDS uses a palette of five zone districts to regulate and generate the intended physical character. Each zone district ("ODDS zone") regulates the following topics:
1. Intent: the intended physical character;
  2. Building Type and Design Site Size: the menu of allowed building types and the associated minimum design site dimensions;
  3. Building Form: the maximum overall building height or stories and minimum and maximum ground floor height;
  4. Building Placement: the minimum to maximum building setbacks, stepbacks, and requirements for façade and frontage within or abutting the façade zone;
  5. Parking: the required location and design requirements for parking and vehicle access;
  6. Frontages: the menu of allowed frontage types required at building entries along rights-of-way and open yards; and
  7. Open Yard: the required location and design requirements for open yard.

## 25.02.030 General Requirements

- A. **Main Building.** Development standards in this Chapter apply to main buildings.
- B. **Accessory Structures.** See *Section 30.140.020 (Accessory Buildings)*.
- C. **Uses.** Allowed uses are regulated by the Base Zone district (e.g., R-2). See *Title 30 (Zoning-Inland)* and *Title 28 (Zoning-Coastal)* of the Santa Barbara Municipal Code.
- D. **Density.** The total number of units per lot must not exceed the maximum allowed by the General Plan or Coastal Land Use Plan land use designation for the site, expressed as a range of dwelling units per acre (du/ac). The maximum number of units identified for each building type is dependent on the design site being large enough to accommodate all the zone's standards (e.g., setbacks, parking, open yard, etc.).
1. Minimum Unit Quantities. The ODDS requires a minimum of two residential units per project.
    - (a) Projects of three or more residential units must exceed, by at least one unit, the maximum base residential density for the base zone (*Section 30.20.030 (Development Standards)*, *Section 30.25.030 (Development Standards)*, and *Section 30.30.030 (Development Standards)*) and comply with the maximum average unit size per *Section 30.150.075 (Process to Establish Density Tier)*.
  2. Density Bonus. ODDS projects may exceed General Plan maximum density by using State or City density bonus in compliance with Chapter 30.145 (Affordable Housing and Density Bonus Incentives) or Section 28.87.400 (Density Bonus and Development Incentives).
- E. **Inclusionary Units.** All ODDS projects must comply with the inclusionary unit requirements.
1. If residential units in a rental housing project are developed using ODDS, the project shall comply with *Section 30.150.110 (Inclusionary Requirements for Rental Housing Projects)*.
  2. If residential units in an ownership housing project are developed using ODDS, the project shall comply with *Section 30.150.080 (Inclusionary Housing Requirements for Ownership Housing Projects)*.
- F. **Prohibition Against Hotel Conversion.** Residential units approved, permitted, or constructed under ODDS shall not be converted to a hotel or other similar use as delineated in *Section 30.295.040.P (Commercial Use Classifications)*.
- G. **Nonresidential Growth Management.** Nonresidential floor area is subject to the requirements of *Chapter 30.170 (Nonresidential Growth Management Program)*.
- H. **Building Form and Placement.** Standards for building height and setbacks are further limited in compliance with the following standards, as applicable, including but not limited to:
1. The requirements of *Section 30.140.170 (Solar Access Height Limitations)*.
  2. The requirements of *Section 25.04.170 (Adjacency and Height Standards)*.
  3. The requirements of *Section 30.30.300 (Development Standards)* for nonresidential portions of mixed-use buildings adjacent to residential zones.
  4. The requirements of the Coastal Zone Special Treatment Area in *Section 28.22.030 (Land Uses Permitted)*.
  5. The requirements of *Section 30.150.090 (Additional Development Incentives)* for market rate ownership projects within the Upper State Street Area (USS) Overlay Zone (*Chapter 30.85*).

- I. **Encroachments.** Encroachments are not allowed within the right-of-way unless approved by a separate encroachment permit in compliance with *Chapter 22.21 (Encroachments Into Public Roads, Streets, Alleys And Rights-Of-Way As Public Nuisance)*.
  1. Encroachments are not allowed across a design site line.
  2. Frontages are allowed to encroach into the primary front and secondary front setbacks by a maximum of 10 feet in the Neighborhood Medium (NM), Neighborhood Large (NL), and Mixed-Use Corridor (MUC) zones.
  3. For all other encroachments, see *Section 30.140.090 (Encroachments into Setbacks and Open Yards)*.

---

## 25.02.040 Design Sites

- A. **Intent.** A design site is a portion of land within a parcel, delineated from other design sites or parcels, to accommodate no more than one building type. The main purpose of a design site is to allow a parcel large enough to contain more than one building type to contain multiple building types while not requiring the legal subdivision of the parcel into additional parcels. Design sites provide flexibility for larger sites to develop with multiple buildings to align with existing development patterns, engage the public realm, and maximize the number of residential units.
- B. **Development Standards.** One parcel can delineate a single or multiple design sites as long as maximum density per the General Plan is not exceeded for the entire parcel and design site minimum width and depth standards per Subsection B (Building Types and Design Site Size) of the Zone can be met. The following standards apply to all design sites. Also see Subsection 25.02.040.C for single design sites and Subsection 25.02.040.D for multiple design sites.
  1. Design site depth shall be measured at the midpoint of the front design site line. Design site width shall be measured by a line connecting two points on opposite interior design site lines that will result in a line parallel to the front design site line.
  2. Determining the Primary and Secondary Front. For the purpose of designating setbacks, façade zone, and frontage, design sites must have a designated front as follows:
    - (a) Design Site abutting only one right-of-way. Design sites must have a primary front. The primary front is the portion of the design site that fronts onto the adjacent right-of-way. Design sites facing a right-of-way shall be parallel to the right-of-way and contiguous with the right-of-way line.
    - (b) Design Site abutting two or more rights-of-way. Design sites must have a primary and secondary front. The primary front is the narrowest portion of the parcel and the secondary front is the widest portion of the parcel that fronts onto either right-of-way. If the portions of the design site fronting onto either right-of-way are equal, the primary front is where the building frontage will be placed.
    - (c) Design Site not abutting a right-of-way. Design sites must have a primary front. The primary front is the portion of the design site that fronts onto a pedestrian pathway, courtyard, or Community Open Space (See Section 25.03.160 (Large Site Standards)) where the building frontage will be placed.

3. A design site shall have only one main building type per Chapter 25.02 (Zones), Subsection B (Building Types and Design Site Size) of the Zone, except for building types identified in Section 25.04.030 (General Requirements).
  4. Design sites with sloped topography shall be developed in compliance with Section 25.03.110 (Sloped Parcels).
  5. Where public improvements are required in compliance with *Section 22.44.070 (Public Improvement Standards)*, design sites shall not include the area of the public improvements.
- C. **Single Design Site Development Standards.** The following standards apply to a project with a single design site that covers the entire project area.
1. The existing lot lines are the design site lines. All portions of the parcel are included within the boundary of the design site.
- D. **Multiple Design Sites Development Standards.** The following standards apply to a project with multiple design sites that cover the entire project area.
1. Multiple design sites are not required to be legally subdivided into individual lots. Subdividing requires a minimum lot size and street frontage for newly created lots that must be in compliance with *Title 28 (Zoning-Coastal)* or *Title 30 (Zoning-Inland)*, and the standards for subdividing in *Title 27 (Subdivisions)*.
  2. Development standards apply to each individual design site, with the exception of the following, which are applied to the entire parcel:
    - (a) Solar access in compliance with *Section 30.140.170 (Solar Access Height Limitations)*;
    - (b) Number of units per General Plan maximum density; and
    - (c) Public improvements.
  3. Location and Orientation. See Figure 25.02.040.1 (Applying Design Sites on Existing Right-of-Way Network) for an example of a project site with multiple design sites abutting three rights-of-way. The size, location, and orientation of new design site lines shall meet the following standards:
    - (a) Each design site shall have a width and depth consistent with the minimum design site sizes in compliance with Chapter 25.02 (Zones), Subsection B (Building Types and Design Site Size) of the Zone, unless approved as an exception due to site conditions per Chapter 25.07 (Exceptions).
    - (b) There should be no remainder; all portions of the parcel must be included within the boundary of the design sites.
    - (c) Design site lines must be straight, unless there is a conflict with the natural environment, in which case the lines shall follow the course of the natural environment, such as top of creek bank.
    - (d) Interior design site lines abutting the right-of-way shall be at right angles perpendicular to the right-of-way on straight streets, or radial to the right-of-way on curved streets.
  4. Parking, driveways, and pedestrian pathways may be shared with adjacent design sites within the same parcel, in compliance with *City of Santa Barbara Access and Parking Design Standards*.
  5. Development projects on parcels of two or more acres are subject to Section 25.03.160 (Large Site Standards).

Figure 25.02.040.1: Applying Design Sites on Existing Right-of-Way Network

**1 Identify Zone**

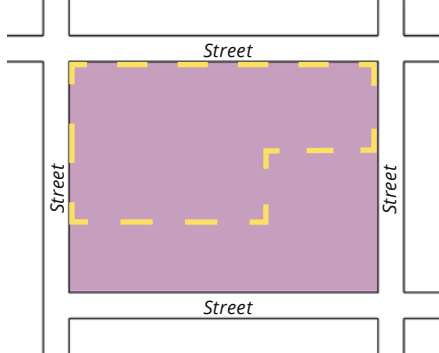

**2 Apply Design Sites**

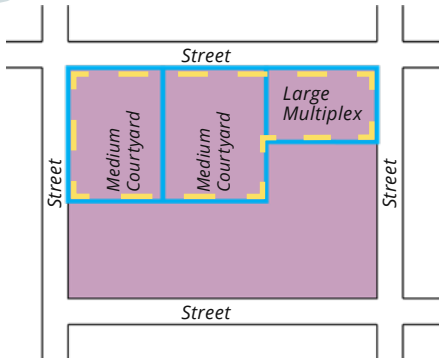

**3 Place Buildings**

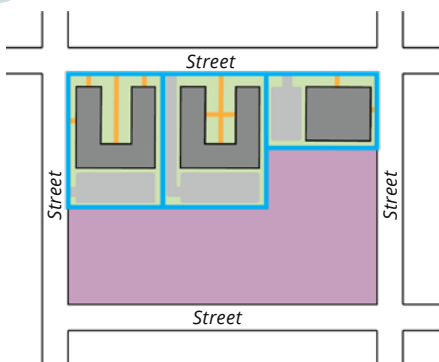

**A. Identify Zone**

1. See Zone Map.
2. See Section 25.02.040 (Design Sites) and Subsection B (Building Types and Design Site Size) of the Zone.

**B. Apply Design Sites**

1. Each design site is required to front onto the adjacent right-of-way. Where public improvements apply, design sites shall not include the right-of-way.
2. Select only one building type for each design site from the allowed building types for the zone and apply the required dimensional standards. (See Subsection B (Building Types and Design Site Size) of the Zone).

**C. Place Buildings**

1. Place each main building on its design site in compliance with the required setbacks and other standards of the Zone.
2. Each building is required to front onto the adjacent right-of-way.
3. Select and apply frontage types to each building (see Subsection F (Frontages) of the Zone).

**Key**

- |                  |               |                            |           |
|------------------|---------------|----------------------------|-----------|
| Project Site     | Main Building | Vehicle Access and Parking | Landscape |
| Design Site Line | Example Zone  | Pedestrian Pathways        |           |

## 25.02.050 Façade Zone

- A. **Intent.** The façade zone is the area between the minimum and maximum front setbacks lines along the primary front, or primary and secondary front for a corner design site. Façade zones place the building and frontages close to the public realm to reinforce pedestrian-oriented development along the right-of-way.
- B. **Development Standards.** Subsection D (Building Placement) of the Zone identifies how much of the building façade is required to be placed along the primary and secondary front.
  1. The façade zone standards apply to new main buildings and their frontages along the primary front or secondary front of a design site.
  2. Façades are allowed to be in any configuration if in compliance with the façade zone requirements in Chapter 25.02 (Zones), Subsection D (Building Placement) of the Zone, façade composition requirements in Section 25.04.160 (Massing and Façade Composition), selected frontage in Chapter 25.05 (Frontages), and the selected architectural style in Chapter 25.06 (Architectural Design).
  3. Only the front most buildings on a design site are subject to the façade zone. For building types that allow more than one building on a design site, see Chapter 25.04 (Building Types), Subsection D (Pedestrian Access) of the Building Type for fronting requirements.
  4. The length of the building required to be in the façade zone is expressed as a minimum and maximum percentage in Chapter 25.02 (Zones), Subsection D (Building Placement) of the Zone. The same method for the primary front applies to the secondary front, using the front and interior building setbacks. See Figure 25.02.050.1 (Determining the Required Amount Subject to the Façade Zone).
    - (a) Identify the width of the design site and apply required interior building setbacks.
    - (b) Subtract the horizontal length between each interior setback from the total width of the design site. The result is the net buildable width of the design site.
    - (c) Multiply the required minimum and maximum percentages in the zone standards by the net buildable width of the design site. The result is the minimum and maximum length, in feet, of building façade and frontage type that is required within or abutting the façade zone. Where no maximum is expressed, the façade may be up to 100 percent in the façade zone. See Figure 25.02.050.2 (Applying the Required Amount to the Façade Zone).

**Figure 25.02.050.1: Determining the Required Amount Subject to the Façade Zone**

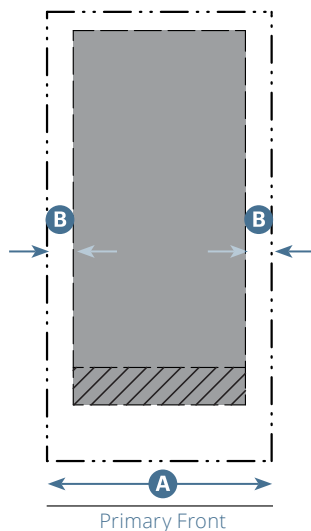



<b>A</b> Design Site Width	50'
<b>B</b> Interior Setback	- 6'
<b>B</b> Interior Setback	- 6'
Net Buildable Width	= 38'
Net Buildable Width	38'
x Zone Standard (e.g., 50%)	x 50%
Façade Required In or Abutting the Façade Zone	= 19'

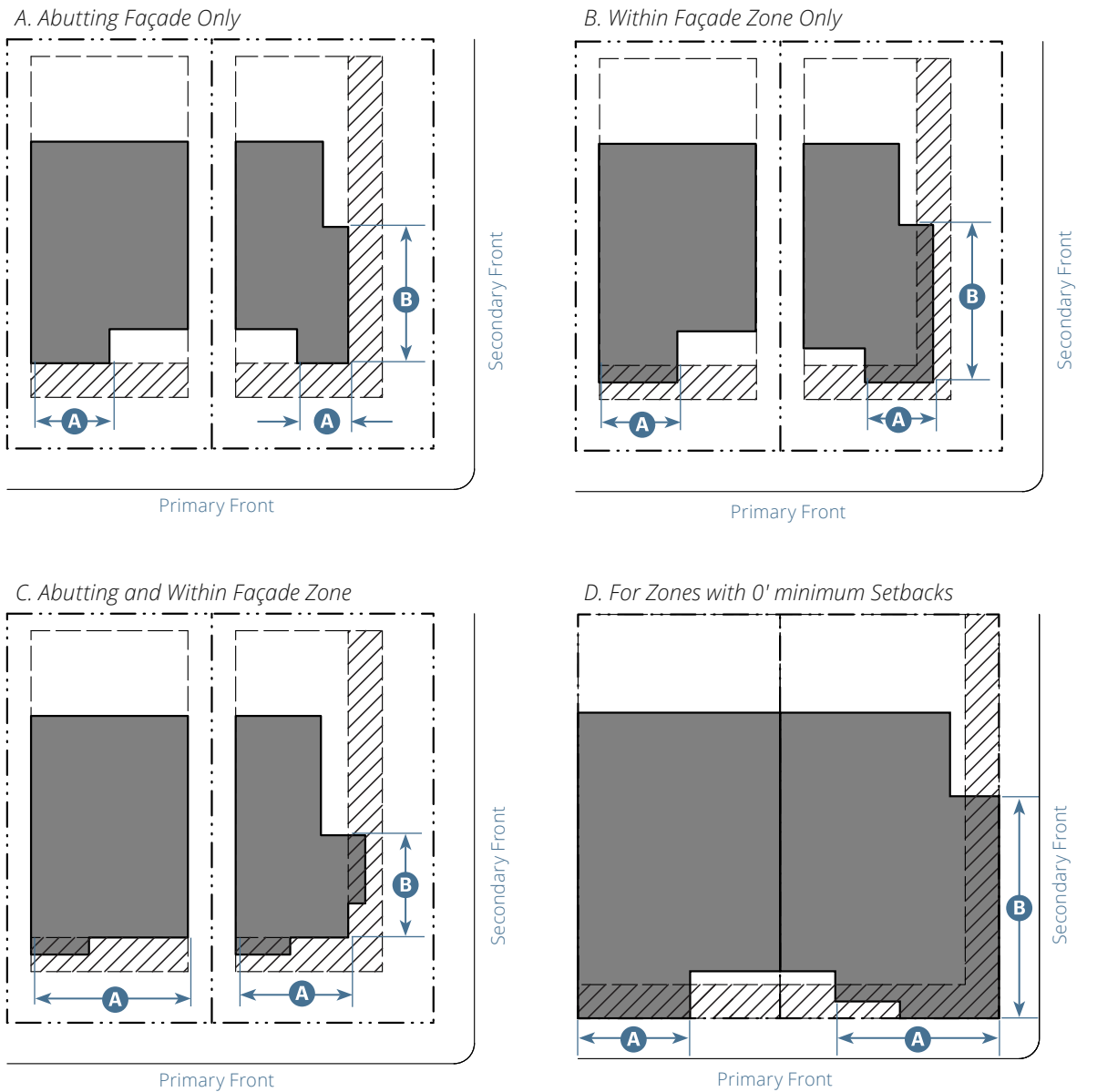

**Figure 25.02.050.2: Applying the Required Amount to the Façade Zone**



	Primary Front	Secondary Front
 Façade Zone	55% min. <sup>1</sup>	45% min. <sup>1</sup>
 Buildable Area for Building and Frontage Type	<b>A</b>	<b>B</b>

<sup>1</sup>See Subsection D (Building Placement) of the Zone.

*This page intentionally left blank*

---

25.02.060 Neighborhood Medium (NM)



**A. Intent**

The intended physical character of the Neighborhood Medium Zone is to promote a walkable neighborhood comprised of low-to-moderate-intensity housing choices. This Zone serves as a transition between lower density, single-unit neighborhoods and higher density, multi-unit and commercial areas.

This Zone is characterized by detached buildings with small footprints and space between buildings. It allows buildings up to 30 feet in height and two and a half stories, with porches, dooryards, and stoops.

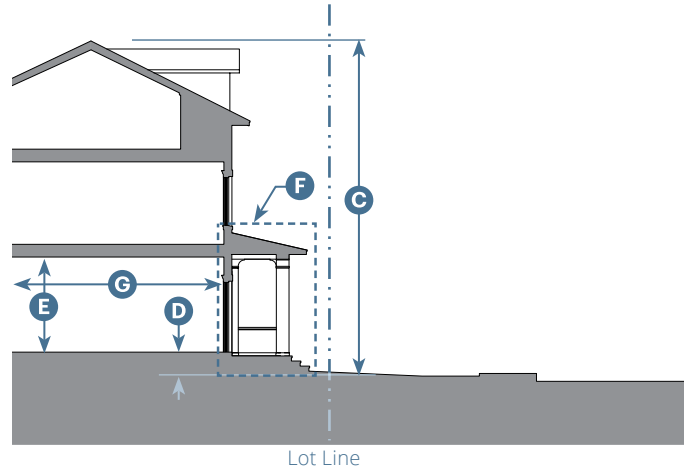
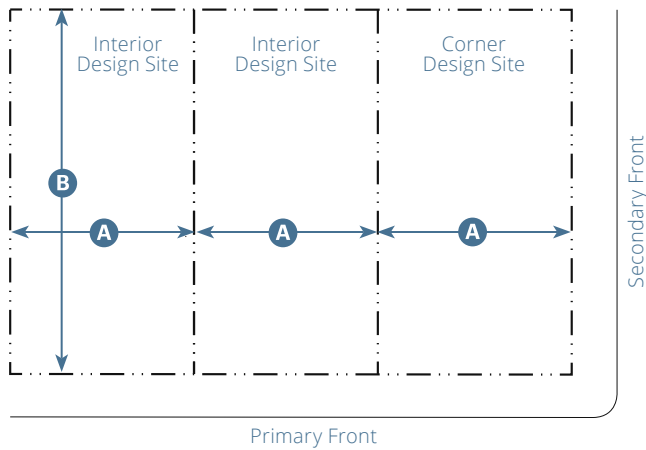

**Key**

--- Lot/Design Site Line

**Key**

--- Lot/Design Site Line

B. Building Types and Design Site Size			
Allowed Building Types	Design Site		Standards
	Width <b>A</b>	Depth <b>B</b>	
<b>House-Scale</b>			
Duplex Side-by-Side	50' min.	100' min.	25.04.050
Duplex Stacked	50' min.	100' min.	25.04.060
Cottage Court	90' min.	120' min.	25.04.070
Medium Multiplex	50' min.	110' min.	25.04.080
Duplex Court	50' min.	110' min.	25.04.090

Each design site shall have only one main building type.

C. Building Form		
Height		
<b>Main Building</b>		
Max. Stories	See standards in Chapter 25.04 (Building Types)	
Overall	30' max.	<b>C</b>
Ground Floor Finish Level <b>D</b>		
Residential	6" min. <sup>1</sup>	
Nonresidential	6" max.	
Ground Floor Ceiling <b>E</b>		
Residential	9' min.	
Nonresidential	12' min.	
Frontage See Subsection F (Frontages) <b>F</b>		
<b>Design Site Coverage</b>		
Max. Building	See standards in Chapter 25.04 (Building Types)	
Footprint		
Depth, Ground-Floor Space <b>G</b>		
Cottage Court	12' min. <sup>2</sup>	
All Building Types	25' min. <sup>2</sup>	

<sup>1</sup> Common entries may be set at grade in compliance with local and federal accessibility standards.

<sup>2</sup> For occupiable space only.

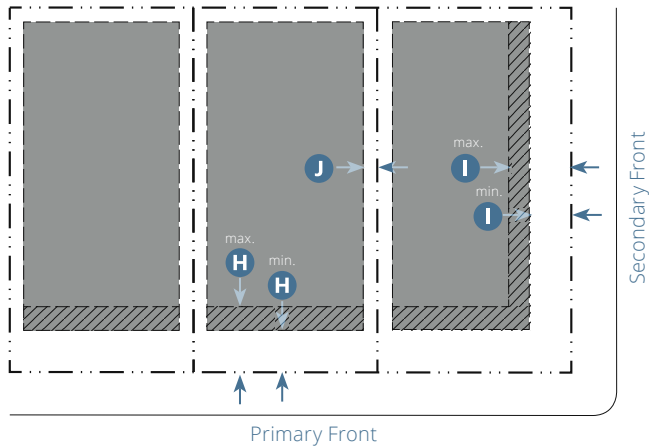

**Key**

- - - Lot/Design Site Line
- - - Building Setback Line
- Buildable Area
- ▨ Façade Zone

**D. Building Placement**

**Setback**

Primary Front (Façade Zone)	15' min.; 20' max.	<b>H</b>
Secondary Front (Façade Zone)	15' min.; 20' max.	<b>I</b>
Front Stepback (portion of structures more than 15' in height)	+5' min.	
Interior	6' min.	<b>J</b>

**Building Façade**

Façade Zone Defined By Main Building/Frontage Type	Primary Front	Secondary Front
Total length of façade required within or abutting façade zone	55% min.	45% min.

**Façade Design**

All building façades shall be designed in compliance with Chapter 25.06 (Architectural Design).

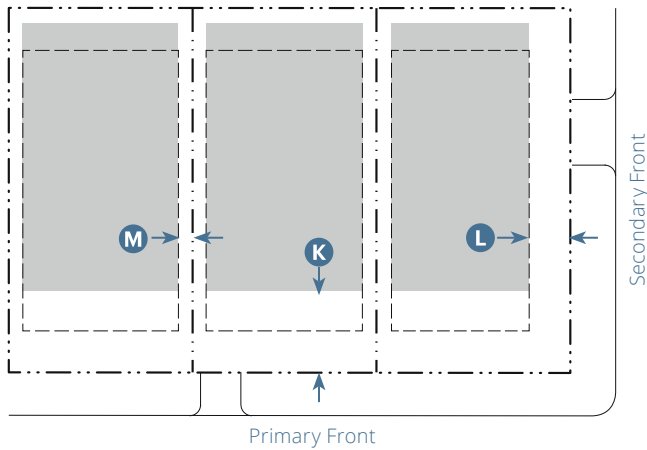

**Key**

- - - Lot/Design Site Line      ■ Parking Area
- - - Building Setback Line

**E. Parking**

**Automobile Spaces Required**

See Chapter 30.175 (Parking Regulations) for required spaces. In the Coastal Zone, see Chapter 28.90 (Automobile Parking Requirements) for required spaces.

**Bicycle Spaces Required**

1 long-term space per residential unit<sup>3</sup>  
 For nonresidential uses, see Chapter 30.175 (Parking Regulations) or Chapter 28.90 (Automobile Parking Requirements) in the Coastal Zone for required spaces.

**Setback**

Primary Front	45' min.	<b>K</b>
Secondary Front		<b>L</b>
Non-street facing	15' min.	
Street-facing	20' min.	
Interior		<b>M</b>
Uncovered	5' min.	
≤ 4 Covered Stalls	3' min.	
5+ Covered Stalls	6' min.	

See Section 25.03.100 (Parking Techniques) for general requirements.

See Chapter 25.04 (Building Types), Subsection E (Vehicle Access and Parking) of the Building Type for allowed parking techniques.

<sup>3</sup> For projects of 3 or more units.

**F. Frontages**

**Allowed Frontage Types**      **Standards**

Allowed Frontage Types	Standards
<b>House-Scale</b>	
Porch Projecting	25.05.040
Porch Recessed	25.05.050
Dooryard	25.05.060
Stoop	25.05.070

**G. Open Yard**

See Section 25.03.040 (Open Yards) for dimensions and additional standards.

## 25.02.070 Neighborhood Large (NL)



### A. Intent

The intended physical character of the Neighborhood Large Zone is to promote a walkable neighborhood of moderate-intensity housing choices. This Zone serves as a transition between medium-density areas and the commercial center.

This Zone is characterized by detached buildings with small to medium footprints and space between buildings. It allows buildings up to 45 feet in height and three stories, which is further refined by the building types, with porches, terraces, and shopfronts.

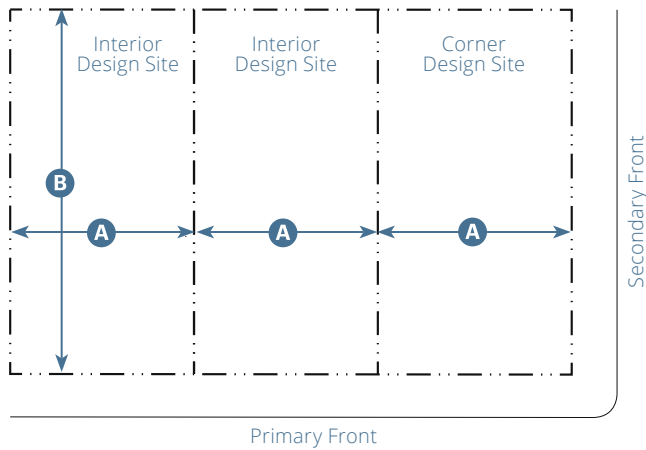

**Key**

--- Lot/Design Site Line

B. Building Types and Design Site Size			
Allowed Building Types	Design Site		Standards
	Width <b>A</b>	Depth <b>B</b>	
<b>House-Scale</b>			
Duplex Side-by-Side	50' min.	100' min.	25.04.050
Duplex Stacked	50' min.	100' min.	25.04.060
Cottage Court	90' min.	120' min.	25.04.070
Medium Multiplex	50' min.	110' min.	25.04.080
Duplex Court	50' min.	110' min.	25.04.090
Side Court	50' min.	100' min.	25.04.100
Medium Courtyard	70' min.	150' min.	25.04.110

Each design site shall have only one main building type.

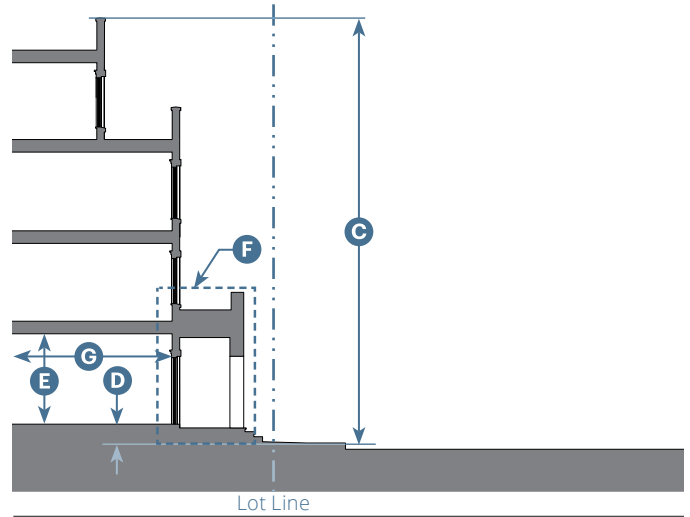

**Key**

--- Lot/Design Site Line

C. Building Form			
Height			
<b>Main Building</b>			
Max. Stories	See standards in Chapter 25.04 (Building Types)		
Overall	45' max.		<b>C</b>
Ground Floor Finish Level			<b>D</b>
Residential	6" min. <sup>1</sup>		
Nonresidential	6" max.		
Ground Floor Ceiling			<b>E</b>
Residential	9' min.		
Nonresidential	12' min.		
Frontage	See Subsection F (Frontages)		<b>F</b>
<b>Design Site Coverage</b>			
Max. Building Footprint	See standards in Chapter 25.04 (Building Types)		
Depth, Ground-Floor Space			<b>G</b>
Cottage Court	12' min. <sup>2</sup>		
All Building Types	25' min. <sup>2</sup>		

<sup>1</sup> Common entries may be set at grade in compliance with local and federal accessibility standards.

<sup>2</sup> For occupiable space only.



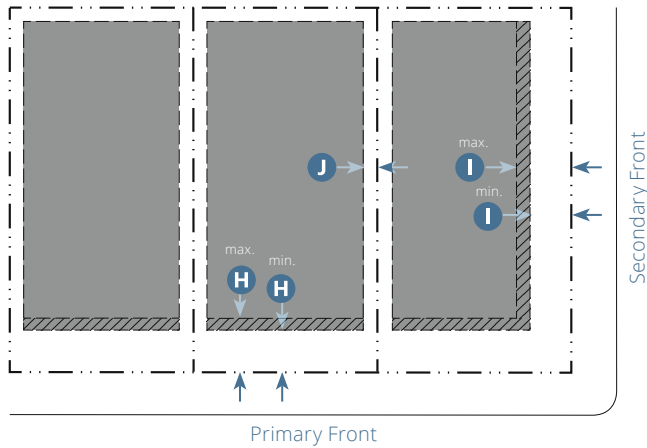

**Key**

- - - Lot/Design Site Line
- - - Building Setback Line
- Buildable Area
- ▨ Façade Zone

**D. Building Placement**

**Setback**

Primary Front (Façade Zone)	10' min.; 15' max.	<b>H</b>
Secondary Front (Façade Zone)	10' min.; 15' max.	<b>I</b>
Interior	6' min.	<b>J</b>
Front Stepback (portions of structures more than 30' in height)	+5' min.	
Interior Stepback (portions of structures more than 30' in height)	+4' min.	

**Building Façade**

Façade Zone Defined By Main Building/Frontage Type	Primary Front	Secondary Front
Total length of façade required within or abutting façade zone	60% min.	50% min.

**Façade Design**

All building façades shall be designed in compliance with Chapter 25.06 (Architectural Design).

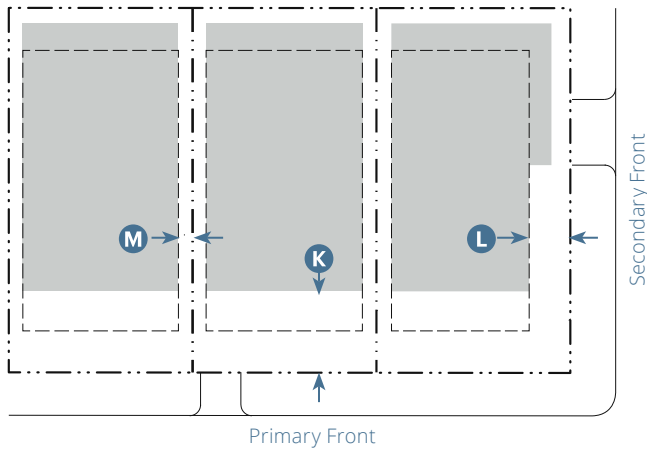

**Key**

- · - · - Lot/Design Site Line
- - - Building Setback Line
- Parking Area

**E. Parking**

**Automobile Spaces Required**

See Subsection 30.150.090.F (Additional Development Incentives) for required spaces and additional standards.  
 In the Coastal Zone, see Chapter 28.90 (Automobile Parking Requirements) for required spaces and additional standards.

**Bicycle Spaces Required**

1 long-term space per residential unit<sup>3</sup>  
 For nonresidential uses, see Chapter 30.175 (Parking Regulations) or Chapter 28.90 (Automobile Parking Requirements) in the Coastal Zone for required spaces.

**Setback**

Primary Front	35' min.	<b>K</b>
Secondary Front		<b>L</b>
Non-street facing	10' min. if > 75' from Primary Front	
	25' min. if ≤ 75' from Primary Front	
Street-facing	20' min.	
Interior		<b>M</b>
Uncovered	5' min.	
≤ 4 Covered Stalls	3' min.	
5+ Covered Stalls	6' min.	

**E. Parking (Continued)**

See Section 25.03.100 (Parking Techniques) for general requirements.  
 See Chapter 25.04 (Building Types), Subsection E (Vehicle Access and Parking) of the Building Type for allowed parking techniques.

<sup>3</sup> For projects of 3 or more units.

**F. Frontages**

Allowed Frontage Types	Standards
<b>House-Scale</b>	
Porch Projecting	25.05.040
Porch Recessed	25.05.050
Dooryard	25.05.060
Stoop	25.05.070
<b>Block-Scale</b>	
Shopfront	25.05.100
Terrace	25.05.110

**G. Open Yard**

See Section 25.04.030 (Open Yards) for dimensions and additional standards.

**25.02.080 Mixed-Use Corridor (MUC)****A. Intent**

The intended physical character of the Mixed-Use Corridor Zone is to promote a walkable neighborhood of moderate-to-high-intensity housing choices. This Zone serves as a neighborhood-serving commercial corridor that supports high-density residential units connected with transit.

This Zone is characterized by detached, medium-to-large footprint buildings with space between buildings. It allows up to 45 feet height and four stories with shopfronts, forecourts, and courtyards.

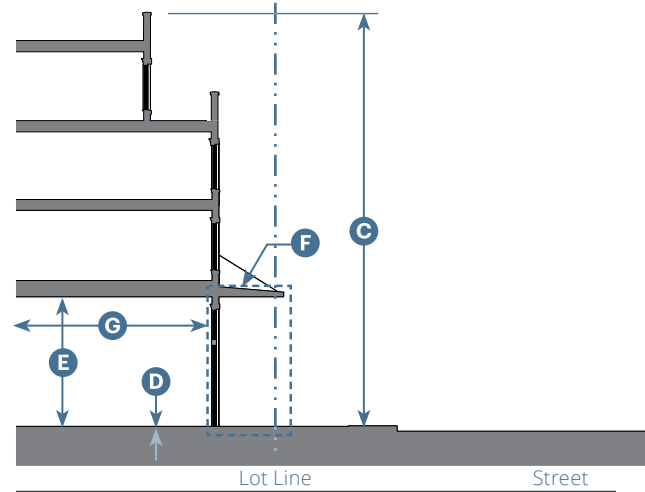
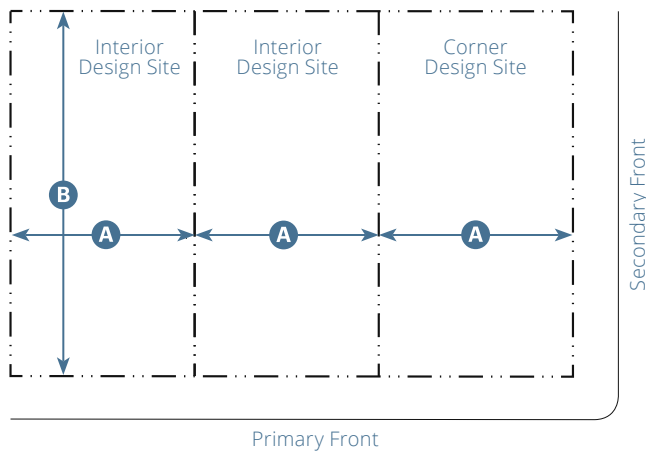

**Key**

- - - Lot/Design Site Line

**Key**

- - - Lot/Design Site Line

B. Building Types and Design Site Size			
Allowed Building Types	Design Site		Standards
	Width <b>A</b>	Depth <b>B</b>	
<b>House-Scale</b>			
Duplex Side-by-Side	50' min.	100' min.	25.04.050
Duplex Stacked	50' min.	100' min.	25.04.060
Cottage Court	90' min.	120' min.	25.04.070
Medium Multiplex	50' min.	110' min.	25.04.080
Duplex Court	50' min.	110' min.	25.04.090
Side Court	50' min.	100' min.	25.04.100
Medium Courtyard	70' min.	150' min.	25.04.110
<b>Block-Scale</b>			
Large Multiplex	75' min.	110' min.	25.04.120
Large Courtyard	75' min.	120' min.	25.04.130

Each design site shall have only one main building type.

C. Building Form		
Height		
<b>Main Building</b>		
Max. Stories	See standards in Chapter 25.04 (Building Types)	
Overall	45' max.	<b>C</b>
Ground Floor Finish Level <b>D</b>		
Residential	6" min. <sup>1</sup>	
Nonresidential	6" max.	
Ground Floor Ceiling <b>E</b>		
Residential	9' min.	
Nonresidential	14' min.	
Frontage <b>F</b>		
	See Subsection F (Frontages)	
<b>Design Site Coverage</b>		
Max. Building Footprint	See standards in Chapter 25.04 (Building Types)	
Depth, Ground-Floor Space <b>G</b>		
Cottage Court	12' min. <sup>2</sup>	
All Building Types	25' min. <sup>2</sup>	

<sup>1</sup> Common entries may be set at grade in compliance with local and federal accessibility standards.

<sup>2</sup> For occupiable space only.

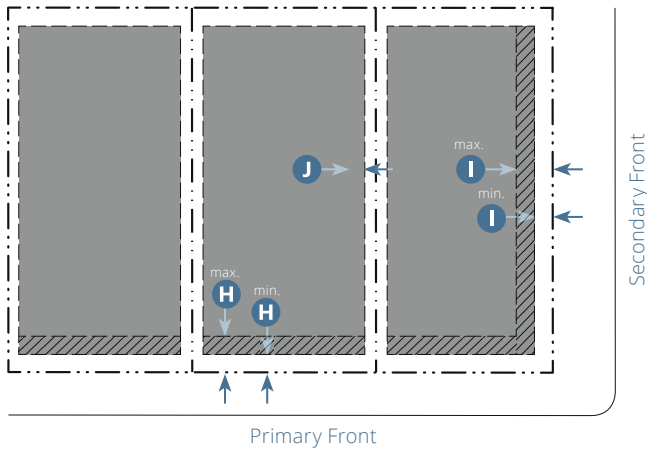

**Key**

- - - Lot/Design Site Line
- - - Building Setback Line
- Buildable Area
- ▨ Façade Zone

**D. Building Placement**

**Setback**

Primary Front (Façade Zone)	10' min.; 15' max.	<b>H</b>
Secondary Front (Façade Zone)	10' min.; 15' max.	<b>I</b>
Interior	6' min.	<b>J</b>
Front Stepback (portions of structures more than 30' in height)	+5' min.	
Interior Stepback (portions of structures more than 30' in height)	+4' min.	

**Building Façade**

Façade Zone Defined By Main Building/Frontage Type	Primary Front	Secondary Front
Total length of façade required within or abutting façade zone	70% min.	60% min.

**Façade Design**

All building façades shall be designed in compliance with Chapter 25.06 (Architectural Design).

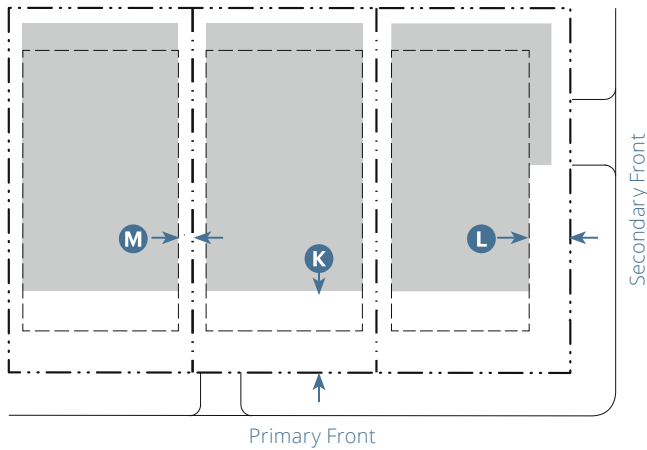

**Key**

- - - Lot/Design Site Line
- - - Building Setback Line
- Parking Area

**E. Parking**

**Automobile Spaces Required**

See Subsection 30.150.090.F (Additional Development Incentives) for required spaces and additional standards. In the Coastal Zone, see Chapter 28.90 (Automobile Parking Requirements) for required spaces and additional standards.

**Bicycle Spaces Required**

1 long-term space per residential unit<sup>3</sup>  
 For nonresidential uses, see Chapter 30.175 (Parking Regulations) or Chapter 28.90 (Automobile Parking Requirements) in the Coastal Zone for required spaces.

**Setback**

Primary Front	35' min.	<b>K</b>
Secondary Front		<b>L</b>
Non-street facing	10' min. if > 75' from Primary Front	
	25' min. if ≤ 75' from Primary Front	
Street-facing	20' min.	
Interior		<b>M</b>
Uncovered	5' min.	
≤ 4 Covered Stalls	3' min.	
5+ Covered Stalls	6' min.	

**E. Parking (Continued)**

See Section 25.03.100 (Parking Techniques) for general requirements. See Chapter 25.04 (Building Types), Subsection E (Vehicle Access and Parking) of the Building Type for allowed parking techniques.

<sup>3</sup> For projects of 3 or more units.

**F. Frontages**

**Allowed Frontage Types**

Allowed Frontage Types	Standards
<b>House-Scale</b>	
Porch Projecting	25.05.040
Porch Recessed	25.05.050
Dooryard	25.05.060
Stoop	25.05.070

**Block-Scale**

Forecourt	25.05.080
Maker Shopfront	25.05.090
Shopfront	25.05.100
Terrace	25.05.110

**G. Open Yard**

See Section 25.03.040 (Open Yards) for dimensions and additional standards.

25.02.090 Downtown Edge (DE)



**A. Intent**

The intended physical character of the Downtown Edge Zone is to promote a walkable neighborhood of high-intensity housing choices. This Zone serves as a transition to Downtown with residential and nonresidential uses able to coexist in the same structure.

This Zone is characterized by both detached and attached buildings with medium-to-large footprints that are typically built up to the property line. It allows buildings up to 48 feet in height and four stories, with shopfronts, courtyards, and arcades.

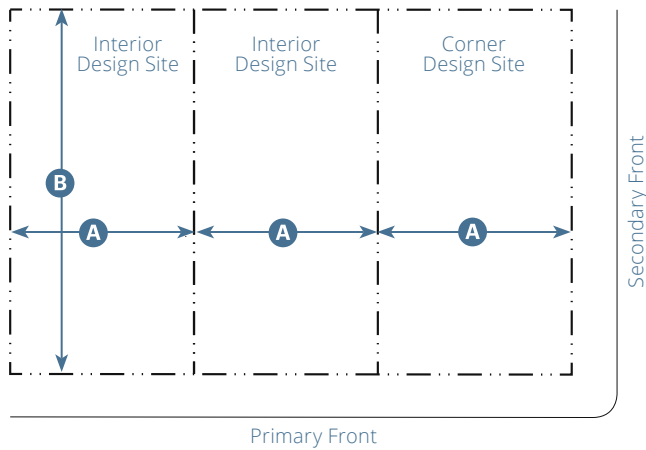

**Key**

--- Lot/Design Site Line

B. Building Types and Design Site Size			
Allowed Building Types	Design Site		Standards
	Width <b>A</b>	Depth <b>B</b>	
<b>House-Scale</b>			
Duplex Side-by-Side	50' min.	100' min.	25.04.050
Duplex Stacked	50' min.	100' min.	25.04.060
Cottage Court	90' min.	120' min.	25.04.070
Medium Multiplex	50' min.	110' min.	25.04.080
Duplex Court	50' min.	110' min.	25.04.090
Side Court	50' min.	100' min.	25.04.100
Medium Courtyard	70' min.	150' min.	25.04.110
<b>Block-Scale</b>			
Large Multiplex	75' min.	110' min.	25.04.120
Large Courtyard	75' min.	120' min.	25.04.130

Each design site shall have only one main building type.

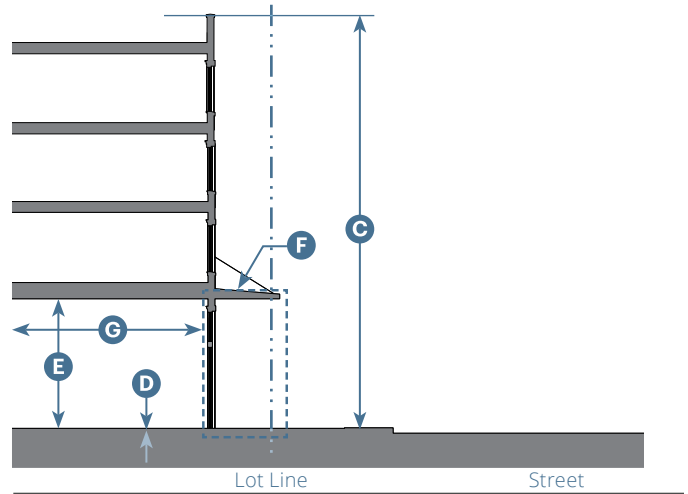

**Key**

--- Lot/ Design Site Line

C. Building Form			
Height			
<b>Main Building</b>			
Max. Stories	See standards in Chapter 25.04 (Building Types)		
Overall	48' max.		<b>C</b>
Ground Floor Finish Level			<b>D</b>
Residential	6" min. <sup>1</sup>		
Nonresidential	6" max.		
Ground Floor Ceiling			<b>E</b>
Residential	9' min.		
Nonresidential	14' min.		
Frontage	See Subsection F (Frontages)		<b>F</b>
<b>Design Site Coverage</b>			
Max. Building Footprint	See standards in Chapter 25.04 (Building Types)		
Depth, Ground-Floor Space			<b>G</b>
Cottage Court	12' min. <sup>2</sup>		
All Building Types	25' min. <sup>2</sup>		

<sup>1</sup> Common entries may be set at grade in compliance with local and federal accessibility standards.

<sup>2</sup> For occupiable space only.



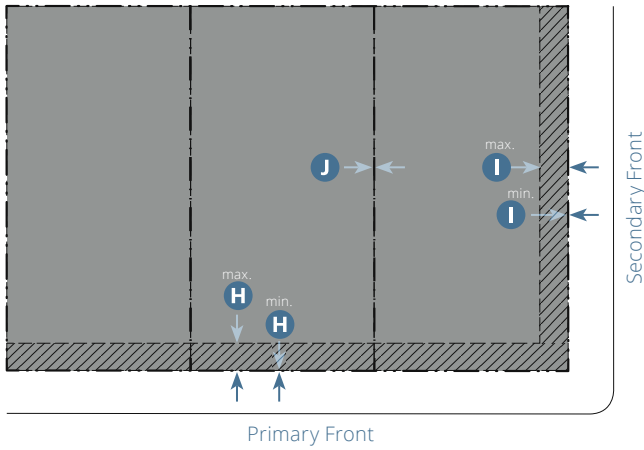

**Key**

- · · · Lot/Design Site Line
- - - Building Setback Line
- Buildable Area
- ▨ Façade Zone

**D. Building Placement**

Setback		
Primary Front (Façade Zone)	0' min.; 10' max.	<b>H</b>
Secondary Front (Façade Zone)	0' min.; 10' max.	<b>I</b>
Interior	0' min. <sup>3</sup>	<b>J</b>

<sup>3</sup>A 6' interior building setback is required when adjacent to a residential base zone.

**Building Façade**

Façade Zone Defined By Main Building/Frontage Type	Primary Front	Secondary Front
Total length of façade required within or abutting façade zone	75% min.; 90% max.	70% min.

**Façade Design**

All building façades shall be designed in compliance with Chapter 25.06 (Architectural Design).

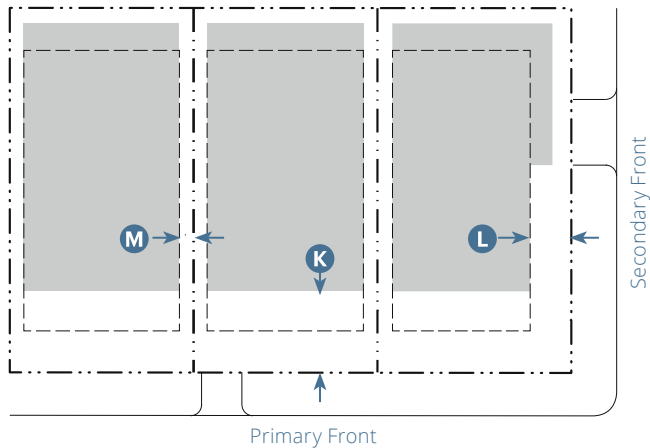

**Key**

- - - Lot/Design Site Line ■ Parking Area
- - - Building Setback Line

**E. Parking**

**Automobile Spaces Required**

See *Subsection 30.150.090.F (Additional Development Incentives)* for required spaces and additional standards.  
 In the Coastal Zone, see *Chapter 28.90 (Automobile Parking Requirements)* for required spaces and additional standards.

**Bicycle Spaces Required**

1 long-term space per residential unit<sup>3</sup>  
 For nonresidential uses, see *Chapter 30.175 (Parking Regulations)* or *Chapter 28.90 (Automobile Parking Requirements)* in the Coastal Zone for required spaces.

**Setback**

Primary Front	35' min.	Ⓚ
Secondary Front		Ⓛ
Non-street facing	5' min. if > 75' from Primary Front	
	35' min. if ≤ 75' from Primary Front	
Street-facing	20' min.	
Interior		Ⓜ
Uncovered	5' min.	
≤ 4 Covered Stalls	0' min.	
5+ Covered Stalls	0' min.	

**E. Parking (Continued)**

See Section 25.03.100 (Parking Techniques) for general requirements.  
 See Chapter 25.04 (Buildings Types), Subsection E (Vehicle Access and Parking) of the Building Type for allowed parking techniques.  
<sup>3</sup> For projects of 3 or more units.

**F. Frontages**

**Allowed Frontage Types** **Standards**

**House-Scale**

Porch Projecting	25.05.040
Porch Recessed	25.05.050
Dooryard	25.05.060
Stoop	25.05.070

**Block-Scale**

Forecourt	25.05.080
Maker Shopfront	25.05.090
Shopfront	25.05.100
Terrace	25.05.110
Gateway	25.05.120
Arcade	25.05.130

**G. Open Yard**

See Section 25.03.040 (Open Yards) for dimensions and additional standards.

**25.02.100 Downtown Core (DC)****A. Intent**

The intended physical character of the Downtown Core Zone is to promote a walkable neighborhood of high-intensity housing choice with priority for housing that enhances and supports the core Central Business District. The Zone offers a mix of residential units and requires ground-floor nonresidential uses along State Street to serve the entire City.

This Zone is comprised of buildings with footprints that cover most of the site, creating a consistent street frontage. Smaller buildings are allowed on smaller lots. It is characterized by attached buildings with medium-to-large building footprints typically built to the property line. It allows buildings up to 48 feet in height and four stories, with shopfronts, arcades, and gateways.

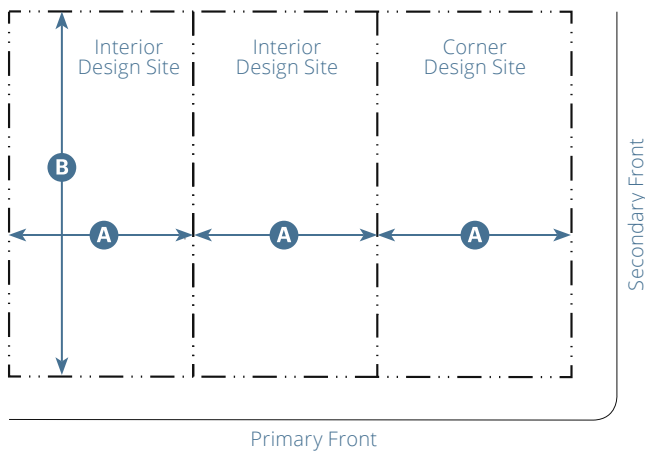

**Key**

--- Lot/Design Site Line

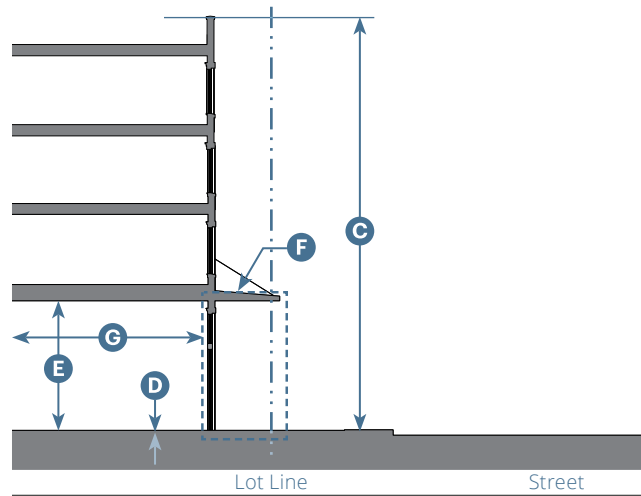

**Key**

--- Lot/Design Site Line

B. Building Types and Design Site Size			
Allowed Building Types	Design Site		Standards
	Width <b>A</b>	Depth <b>B</b>	
Duplex Side-by-Side	50' min.	100' min.	25.04.050
Duplex Stacked	50' min.	100' min.	25.04.060
Cottage Court	90' min.	120' min.	25.04.070
Medium Multiplex	50' min.	110' min.	25.04.080
Duplex Court	50' min.	110' min.	25.04.090
Side Court	50' min.	100' min.	25.04.100
Medium Courtyard	70' min.	150' min.	25.04.110
Block-Scale			
Large Multiplex	75' min.	110' min.	25.04.120
Large Courtyard	75' min.	120' min.	25.04.130
Downtown Building	25' min.	100' min.	25.04.140

Each design site shall have only one main building type.

C. Building Form			
Height			
Main Building			
Max. Stories	See standards in Chapter 25.04 (Building Types)		
Overall	48' max.		<b>C</b>
Ground Floor Finish Level			<b>D</b>
Residential	6" min. <sup>1</sup>		
Nonresidential	6" max.		
Ground Floor Ceiling			<b>E</b>
Residential	9' min.		
Nonresidential	14' min.		
Frontage	See Subsection F (Frontages)		<b>F</b>
Design Site Coverage			
Max. Building Footprint	See standards in Chapter 25.04 (Building Types)		
Depth, Ground-Floor Space			<b>G</b>
Cottage Court	12' min. <sup>2</sup>		
All Building Types	25' min. <sup>2</sup>		

<sup>1</sup> Common entries may be set at grade in compliance with local and federal accessibility standards.

<sup>2</sup> For occupiable space only. Projects on lots fronting State Street between Montecito Street and Sola Street are required to provide ground floor nonresidential uses.

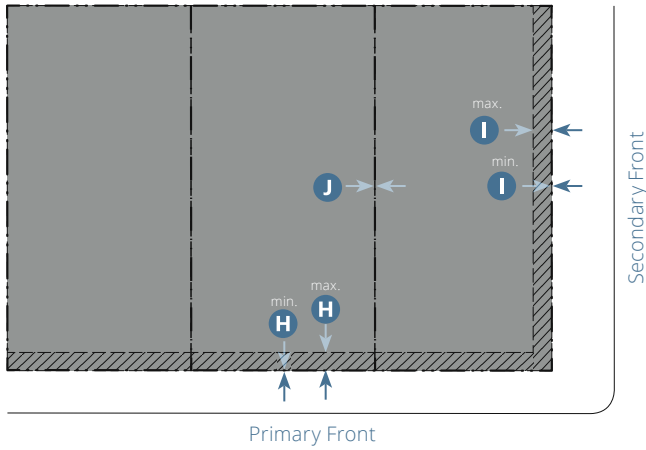

**Key**

- - - Lot/Design Site Line
- - - Building Setback Line
- Buildable Area
- ▨ Façade Zone

**D. Building Placement**

**Setback**

Primary Front (Façade Zone)	0' min.; 10' max.	<b>H</b>
Secondary Front (Façade Zone)	0' min.; 10' max.	<b>I</b>
Interior	0' min. <sup>3</sup>	<b>J</b>

<sup>3</sup>A 6' interior building setback is required when adjacent to a residential base zone.

**Building Façade**

Façade Zone Defined By Main Building/Frontage Type	Primary Front	Secondary Front
Total length of façade required within or abutting façade zone	80% min.; 90% max.	80% min.

**Façade Design**

All building façades shall be designed in compliance with Chapter 25.06 (Architectural Design).

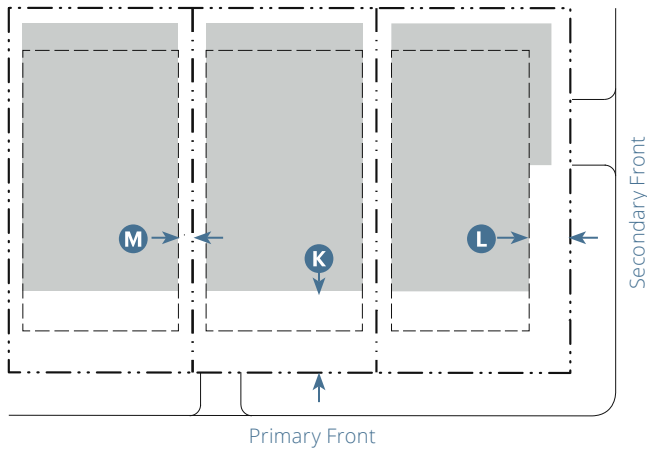

**Key**

- - - Lot/Design Site Line
- - - Building Setback Line
- Parking Area

**E. Parking**

**Automobile Spaces Required**

See Subsection 30.150.090.F (Additional Development Incentives) for required spaces and additional standards. In the Coastal Zone, see Chapter 28.90 (Automobile Parking Requirements) for required spaces and additional standards.

**Bicycle Spaces Required**

1 long-term space per residential unit<sup>3</sup>  
 For nonresidential uses, see Chapter 30.175 (Parking Regulations) or Chapter 28.90 (Automobile Parking Requirements) in the Coastal Zone for required spaces.

**Setback**

Primary Front	35' min.	<b>K</b>
Secondary Front		<b>L</b>
Non-street facing	5' min. if > 75' from Primary Front 35' min. if ≤ 75' from Primary Front	
Street-facing	20' min.	
Interior		<b>M</b>
Uncovered	5' min.	
≤ 4 Covered Stalls	0' min.	
5+ Covered Stalls	0' min.	

**E. Parking (Continued)**

See Section 25.03.100 (Parking Techniques) for general requirements. See Chapter 25.04 (Building Types), Subsection E (Vehicle Access and Parking) of the Building Type for allowed parking techniques.

<sup>3</sup> For projects of 3 or more units.

**F. Frontages**

Allowed Frontage Types	Standards
------------------------	-----------

House-Scale	
Porch Projecting	25.05.040
Porch Recessed	25.05.050
Dooryard	25.05.060
Stoop	25.05.070

**Block-Scale**

Forecourt	25.05.080
Maker Shopfront	25.05.090
Shopfront	25.05.100
Terrace	25.05.110
Gateway	25.05.120
Arcade	25.05.130

**G. Open Yard**

See Section 25.03.040 (Open Yards) for dimensions and additional standards.

# Chapter 25.03 General Site Design Standards

---

## Sections:

25.03.010	Purpose
25.03.020	General Requirements
25.03.030	Habitat Buffers
25.03.040	Open Yards
25.03.050	Landscape
25.03.060	Lighting
25.03.070	Fences and Hedges
25.03.080	Screening
25.03.090	Trash Enclosures
25.03.100	Parking Techniques
25.03.110	Sloped Parcels
25.03.120	Retaining Walls
25.03.130	Privacy
25.03.140	Rooftop Decks
25.03.150	Ground Surfaces and Paving
25.03.160	Large Site Standards

---

## 25.03.010 Purpose

This Chapter provides site design standards which are applicable to all projects. Many of these standards focus on the concept of "livability", as it pertains to a person's home and neighborhood. Desirable livability design features include landscape, access to light and air, attenuation of noise, safety, and privacy to and from neighboring properties. The standards ensure that new development makes a positive contribution to the development patterns of the area; and does not adversely affect neighboring properties, with "adversely affect" meaning to impact in a substantial, negative manner the livability of properties adjacent to new development.

---

## 25.03.020 General Requirements

- A. **Applicability.** This Chapter includes development and site standards that apply to development in all ODDS zones. These standards are to be used in conjunction with *Chapter 30.140 (General Site Regulations)*, *Chapter 28.87 (General Provisions)*, and *Title 22 (Environmental Policy and Construction)*, as applicable.
- B. **Storm Water.** Storm water runoff requirements are site design element and best management practices to satisfy the Storm Water Management Program's standards for peak runoff discharge management, runoff volume reduction, and water quality treatment as specified in the Storm Water Best Management Practices (BMP) Guidance Manual. Development shall comply with the Storm Water Runoff Requirements applicable to the activity as provided in the BMP Guidance Manual in compliance with *Chapter 22.87 (Storm Water Management)*.

- C. **Archaeological and Paleontological Resources.** Development shall be designed and constructed wherever feasible to avoid destruction of archaeological and paleontological resources in compliance with *Chapter 22.12 (Archaeological and Paleontological Resources)*.
- D. **Flood Plain Management.** Notwithstanding the ground floor finish height standards in Chapter 25.02 (Zones), Subsection C (Building Form) of the Zone, or the frontage finish level above sidewalk in Chapter 25.05 (Frontages), Subsection B (Required Elements) of the Frontage, development in areas of special flood hazards shall be designed and constructed in compliance with *Chapter 22.24 (Floodplain Management)*.
- E. **Undergrounding of Utilities.** All service connections for utilities, except for distribution facilities, shall be installed underground, unless undergrounding of utilities is exempted in compliance with *Chapter 22.38 (Undergrounding of Utilities)*.

---

### 25.03.030 Habitat Buffers

- A. **Intent.** These standards are designed to protect areas of biological significance with the use of buffers and development restrictions.
- B. **Inland Creek Buffer Area.** No development shall be located within the development limitation area in compliance with *Section 30.140.050 (Development Along Mission Creek)* or any other Inland Creek Buffer Area, as may be established by ordinance. Top of bank must be measured in compliance with *Section 30.15.040 (Determining Creek Top of Bank)* or any other ordinance which may be adopted establishing measurement of top of bank.
  - 1. A project may not include a request for an exception to this standard by applying for a variance, modification, exception, waiver, or other approval.
- C. **Applicability.** The Inland Creek Buffer Area standard shall be repealed and replaced with applicable creeks standards when adopted in *Title 22 (Environmental Policy and Construction)* of the Municipal Code.
- D. **Coastal Creek, Wetlands, and Environmentally Sensitive Habitat Area (ESHA) Buffer Areas.** Development in the Coastal Zone shall comply with coastal creek, wetlands, and ESHA habitat buffer area policies of the *Coastal Land Use Plan* in compliance with *Section 25.01.050 (Relationship to Local Coastal Program)*.



**25.03.040 Open Yards**

- A. **Intent.** These standards provide space for recreational and leisure activities, allow for increased light and air, provide permeable surfaces for storm water retention, improve the visual environment, and increase livability.
- B. **Standards.** All open yard minimum area and dimensions shall be in compliance with *Section 30.140.140 (Open Yards)* except as noted below.
  - 1. The minimum common and private open yard must be located within the design site boundary for each building type.
  - 2. Design sites developed with the Duplex Side-by-Side, Duplex Stacked, and Duplex Court Building Types must provide open yard in compliance with *Section 30.140.140.C.1 (Open Yards)*.
  - 3. Projects on design sites in the Mixed-Use Corridor (MUC), Downtown Edge (DE), and Downtown Core (DC) zones may provide an alternative common open yard in compliance with *Section 30.150.090.G.2.B. (Additional Development Incentives)*.
  - 4. All other Building Types must provide common and private open yard in compliance with *Section 30.140.140.C.2 (Open Yards)*.

**25.03.050 Landscape**

- A. **Intent.** These standards are intended to enhance the natural environment, create a successful pedestrian experience, and promote the efficient use of water resources. These standards are also intended to improve air quality, absorb storm water runoff, protect environmentally sensitive areas, and increase tree planting to provide shade and reduce the urban heat island effect.
- B. **Landscape Areas to be Unobstructed.** Required landscape areas must be provided on the ground level and must be open, unenclosed, and unobstructed by structures from the ground upward, except as provided in *Section 30.140.090 (Encroachments into Setbacks and Open Yards)*.
- C. **Minimum Percentage and Dimensions.** Landscape shall be provided and maintained in compliance with Table 25.03.050.A (Minimum Landscaped Areas by Zone).
  - 1. The minimum area of a design site to be landscaped can be combined with the minimum area of common or private ground level open yard in compliance with Section 25.03.040 (Open Yards) and setbacks.

Table 25.03.050.A: Minimum Landscaped Areas by Zone			
Landscape Requirements	Zones		
	NM	NL	MUC, DE, and DC
Minimum Landscape Area (as percent of Design Site)	20%	15%	No minimum, except compliance with Subsection 25.03.050.D (Required Landscape Areas)
Minimum Dimension of Landscape Area	2 feet wide in any direction		

- D. **Required Landscape Areas.** Each design site shall provide and maintain the following required landscape areas, even if there is no minimum percentage of design site area that must be landscaped pursuant to Table 25.03.050.A (Minimum Landscaped Areas By Zone). The following locations on a design site shall be landscaped on the ground level, and may count toward the minimum percentage of design site landscape:
1. Front Setback. All front setbacks, except areas used for exit, entry, and frontages shall be landscaped.
    - (a) Shade Trees. In the Neighborhood Medium (NM) zone, at least one 24-inch box tree shall be planted in the front setback, unless approved as an exception due to site constraints per Chapter 25.07 (Exceptions).
  2. Driveways and Parking Lots. Driveways and parking areas shall be landscaped per *Section 30.175.080 (Parking Area Landscape and Fence Standards)*.
  3. Parkway Planting. In addition to on-site landscape, parkway planting consistent with *Chapter 15.20 (Tree Planting and Maintenance)* shall be provided.
  4. Retaining Walls. Multiple terraced retaining walls shall be landscaped in the entire horizontal area between retaining walls.
- E. **Landscape Design Standards.** Landscape shall comply with the following:
1. Plant Material.
    - (a) Landscape may consist of any combination of living groundcovers, shrubs, vines, and trees. Plant size and spacing shall be based on the species selected and shall be installed to achieve intended coverage of the landscaped area within three years.
    - (b) Landscape and ground cover shall consist of live plant material. The use of indoor/outdoor carpeting, synthetic turf, or artificial shrubs, flowers, trees, or vines instead of living plants is prohibited.
    - (c) Hardscape featuring pervious paver stones, gravel, sand, wood, and decomposed granite may be used to satisfy up to 50 percent of the required landscape area. Landscape may include benches and sculptures placed within the landscaped setting.
  2. Species Selection. Plant species shall be selected in compliance with the *City's Water Efficient Landscape Standards*.
  3. Existing Vegetation.
    - (a) Trees protected by *Chapter 15.24 (Preservation of Trees)* shall not be removed or adversely affected without a permit.
    - (b) Trees allowed to be removed with a permit must be replaced on site on a minimum one to one basis.
- F. **Landscape and Irrigation Plans.** Landscape and irrigation plans must be prepared in compliance with the *City's Water Efficient Landscape Standards* and submitted with each development application.
- G. **Storm Water Management.** Landscape may be used for storm water Best Management Practices (BMPs) using biofiltration and retention and detention areas in compliance with *Chapter 22.87 (Storm Water Management)*.

---

### 25.03.060 Lighting

- A. **Intent.** This Section provides standards to promote high quality exterior lighting and efficient use of energy to reduce light pollution, glare, and light trespass.
- B. **Exterior Lighting.** Exterior Lighting shall be provided in compliance with the following:
  - 1. Lighting body, mount, and shield materials shall be selected from Chapter 25.06 (Architectural Design), Subsection Q (Materials) of the Architectural Style.
  - 2. All lighting shall be designed, located, and lamped with the light directed downward.
  - 3. Uplighting of the building façade, internally illuminated fascia, wall, roof, awning or other building parts and spot lighting or broadcast lighting are prohibited.
  - 4. Light fixtures shall use refractors, louvers, patterned, or translucent glass to obscure view of the lamp. Lamps that are not fully shielded shall not exceed 1,200 lumens.
  - 5. All lighting shall use lower color temperature lamps of no more than 3000 Kelvin to minimize blue light emissions.
  - 6. All parking lot lights shall be full cutoff luminaires, as certified by the manufacturer, with the light source directed downward and away from adjacent residences.
  - 7. Bollard and other path light fixtures shall be black, bronze, or Malaga green (i.e., RAL 6012, also known as black green) in color.

---

### 25.03.070 Fences and Hedges

- A. **Intent.** This Section provides standards for fences and hedges to support pedestrian-oriented development, protect property, enhance privacy, attenuate noise, and improve the visual environment.
- B. **Retaining Walls.** Refer to Section 25.03.120 (Retaining Walls).
- C. **Height Limitations.**
  - 1. Fences and hedges shall not exceed 42 inches in height within the first 10 feet of the front design site line, and shall not exceed five feet in height within the front setbacks, the façade zone, and frontages.
  - 2. Fences and hedges shall not exceed eight feet in height within interior setbacks.
  - 3. Maximum height of fences and hedges may be further limited in compliance with *Section 30.140.230 (Visibility at Driveways and Intersections)*.
- D. **Measuring the Height of Fences and Hedges.** The height of fences and hedges must be measured consistent with *Section 30.15.090 (Measuring Height)*.
  - 1. In situations where a hedge is located above a retaining wall, or within five feet of a fence, the overall combined height shall be the same as the maximum allowed height of a hedge for that location.

- E. **Fence Elements.** Pilaster caps, finials, posts, and lighting fixtures shall not exceed the maximum height by more than 12 inches in compliance with the following:
  - 1. Each element shall not exceed nine inch by nine inch wide.
  - 2. Each element shall be spaced a minimum of six feet apart, measured on-center.
  - 3. Elements must match the materials allowed for the architectural style.
- F. **Materials.** Refer to Chapter 25.06 (Architectural Design), Subsection Q (Materials) of the Architectural Style.
- G. **Temporary Fencing.** Temporary fencing may be used to provide security for construction sites, or vacant structures and land, which cannot otherwise be secured. All temporary fencing shall be in compliance with this section and the following standards:
  - 1. Must be green mesh, wood, or chain link with vine planting;
  - 2. Must not exceed six feet in height;
  - 3. Must not include signage, banners, or graffiti; and
  - 4. Must be removed when use is no longer required.

---

## 25.03.080 Screening

- A. **Intent.** This Section provides standards for screening to minimize visual, noise, and privacy impacts to surrounding properties and rights-of-way and improve the overall visual environment.
- B. **Height Maximums.** Fences and hedges used for screening shall not exceed the maximum heights identified in Section 25.03.070 (Fences and Hedges).
- C. **Landscape Screening.** Landscape used for screening shall be installed in compliance with Section 25.03.050 (Landscape).
- D. **Trash Enclosures.** All refuse bins, containers, and bundles must be within a walled or fenced enclosure with one or more gates for access in compliance with Section 25.03.090 (Trash Enclosures) or screened from public view by a fence or hedge in compliance with Section 25.03.070 (Fences and Hedges).
- E. **Mechanical and Other Equipment Screening**
  - 1. New or relocated mechanical equipment shall be located and screened in compliance with *Section 30.140.130 (Mechanical and Other Equipment)* and the following standards:
    - (a) **Roof-Mounted Equipment.** Building parapets or other architectural elements in the building's architectural style shall screen roof-mounted equipment.
      - (1) Buildings shall be designed to provide a parapet or other architectural element that is as tall or taller than the highest point on any mechanical equipment to be located on the roof of the building.

- (b) Attached and Free-Standing Equipment.
  - (1) Attached equipment shall be screened or painted the color of the main building, unless a different color is required by code.
  - (2) Free-standing equipment screened by landscape shall be painted black or black green (i.e., RAL 6012) , unless a different color is required by code.
  - (3) All screen devices shall be as high as the highest point of the equipment being screened.
- 2. The following mechanical equipment is exempt from screening:
  - (a) Free-standing or roof-mounted Solar Energy Systems; and
  - (b) Electric Vehicle charging equipment.

---

### 25.03.090 Trash Enclosures

- A. **Intent.** This Section provides standards for trash enclosures consistent with City standards for screening such facilities from public view; and providing space efficiency, sufficient capacity, and access.
- B. **Capacity and Design.** All waste, recycling, and trash enclosure areas must comply with the *City's Trash and Recycling Enclosure Design Guide* regarding distance from building, truck access point, siting considerations for driveways and parking lots, requirements for parking garages and indoor locations, capacity, size, and number of containers, container layout, and roof clearance and drainage.
- C. **Location.** Trash enclosures must be located within 50 feet from the truck access point and shall not be located in any of the following:
  - 1. Required setbacks;
  - 2. Between the main building and the right-of-way;
  - 3. Within any open yard, pedestrian pathway, or Community Open Space;
  - 4. Within any frontage type; or
  - 5. Within any parking space.
- D. **Screening.** All waste, recycling, and trash enclosure areas shall comply with the requirements of Section 25.03.080 (Screening).
- E. **Height Limitations.** Trash enclosures must comply with all height limitations pursuant to *Section 30.140.230 (Visibility at Driveways and Intersections)*.
- F. **Maintenance.** Trash enclosures must be maintained in good condition, free of visible debris, and shall not be used for anything other than storing waste and recycling receptacles. Trash enclosure storage areas shall not create a nuisance, hazard, or other objectionable condition, pursuant to *Chapter 30.180 (Performance Standards)*.
- G. **Materials and Colors.** Enclosure wall, roof materials, and colors shall be selected from the materials listed in Chapter 25.06 (Architectural Design), Subsection Q (Materials) of the Architectural Style. Materials for enclosure floors and gates must be in compliance with the *Trash and Recycling Enclosure Design Guide*.

---

## 25.03.100 Parking Techniques

- A. **Intent.** This Section provides standards for functional parking techniques to enhance pedestrian-oriented development and minimize the visual impact of automobiles and parking structures.
- B. **Number of Spaces and Location.** Number of spaces is regulated by *Chapter 30.175 (Parking Regulations)* and *Chapter 28.90 (Automobile Parking Requirements)*. All parking shall be located in compliance with Chapter 25.02 (Zones), Subsection E (Parking) of the Zone.
- C. **Bicycle Parking.** Bicycle parking location and other standards shall be provided in compliance with *Chapter 30.175 (Parking Regulations)* and the *City's Access and Parking Design Standards*.
- D. **Type of Allowed Parking.** See Chapter 25.04 (Building Types), Subsection E (Vehicle Access and Parking) of the Building Type.
- E. **Parking Techniques.** The following techniques may be applied individually or in combination in compliance with Chapter 25.02 (Zones), Subsection E (Parking) of the Zone:
1. Minimum dimensions and maneuvering areas for all parking techniques shall be in compliance with the *City's Access & Parking Design Standards*.
  2. Visibility at driveways shall be maintained in compliance with *Section 30.140.230 (Visibility at Driveways and Intersections)*.
  3. Driveways and parking areas may be shared among adjacent design sites on the same lot or in an offsite facility in compliance with *Section 30.175.060 (Location of Required Automobile and Bicycle Parking)*.
  4. Design sites with alley access must be accessed from the alley unless approved as an exception per Chapter 25.07 (Exceptions).
  5. Corner design site parking access must be from the secondary front unless access from the primary front can be approved as an exception per Chapter 25.07 (Exceptions).
  6. Uncovered Parking.
    - (a) Uncovered parking areas shall be landscaped in compliance with *Section 30.175.080 (Parking Area Landscape and Fence Standards)*.
  7. Covered Parking.
    - (a) Any parking structure, including individual garages and carports, shall be designed in compliance with the architectural style described in Chapter 25.06 (Architectural Design).
    - (b) A stacked parking system may be allowed if within a fully enclosed structure, not publicly visible along the primary front, and designed in compliance with the Parking Lifts & Machines standards in the *City's Access & Parking Design Standards*.
    - (c) Tuck-under, subterranean, and podium parking shall not be publicly visible along the primary front and the automobile entry shall be setback a minimum 10 feet from the building façade.
    - (d) Subterranean Parking.
      - (1) Subterranean parking is not counted as a story if in compliance with Determining the Number of Stories in a Building pursuant to *Section 30.15.090 (Measuring Height)*.
      - (2) Subterranean parking counted as a story in compliance with *Section 30.15.090 (Measuring Height)* must comply with building form and placement standards in Chapter 25.02 (Zones), Subsection C (Building Form) and Subsection D (Building Placement) of the Zone.

**25.03.110 Sloped Parcels**

- A. **Intent.** This Section provides the standards for development in all zones on design sites with sloped topography consistent with City policies and standards for grading and development that considers visual impacts and geologic conditions such as erosion, landslides, and drainage.
- B. **Building Height.**
  - 1. **Maximum Building Height.** Building height is regulated by Chapter 25.02 (Zones), Subsection C (Building Form) of the Zone. The maximum allowed height of a building shall follow the existing or finished grade of the design site in compliance with the allowed building height.
    - (a) Figure 25.03.110.1 (Site Grading for House-Scale Building Forms) and Figure 25.03.110.2 (Site Grading for Block-Scale Building Forms) illustrate allowed and non-allowed site grading methods.
  - 2. **Exposed Basements.** Basements are not counted as a story if in compliance with Determining the Number of Stories in a Building pursuant to *Section 30.15.090 (Measuring Height)*.

**Figure 25.03.110.1: Site Grading for House-Scale Building Forms**

The following examples apply to the following building types: Duplex Side-by-Side, Duplex Stacked, Cottage Court, Medium Multiplex, Duplex Court, Side Court, and Medium Courtyard.

**Allowed.** Grading that results in each new building reflecting the topography of the design site, connecting each building with the adjacent street.

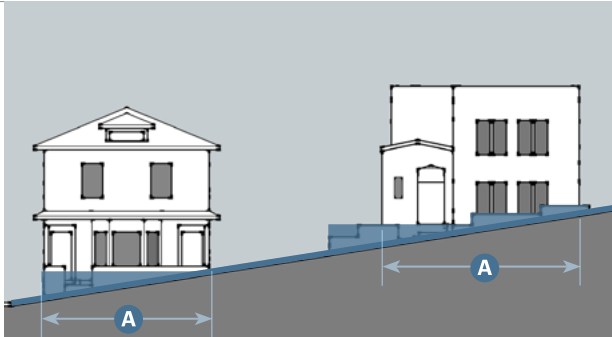

Building footprint width is required to step with the slope.

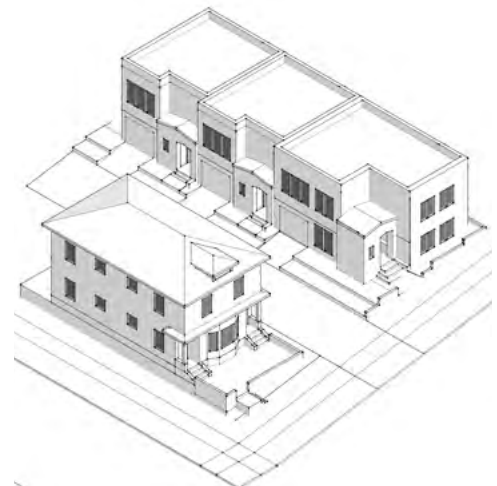

**Not Allowed.** Grading that does not result in each new building reflecting the topography of the design site, disconnecting one or more buildings from the adjacent street.

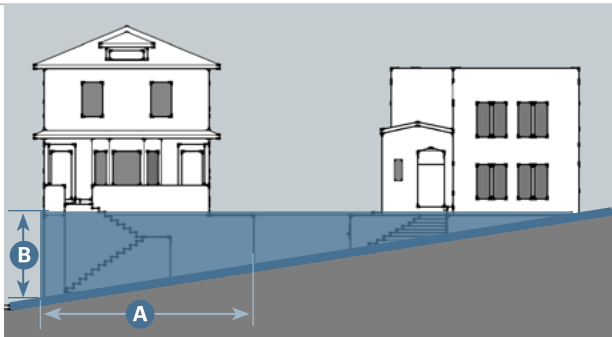

Building footprint width does not step with slope.



Finished grade of terraced design site is more than four feet from the adjacent street/right-of-way.

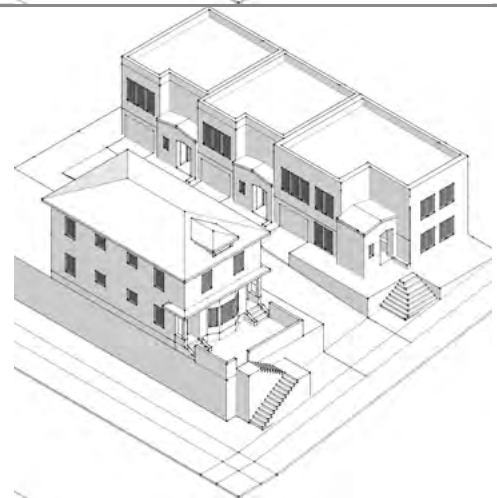

**Figure 25.03.110.2: Site Grading for Block-Scale Building Forms**

**Allowed Site Grading.** The following examples apply to the following building types: Large Multiplex, Large Courtyard, and Downtown Building.

**Allowed.** Grading that results in each new building fronting on the adjacent street, connecting the building façades to the adjacent street, and avoiding retaining walls taller than four feet along a street or community open space.

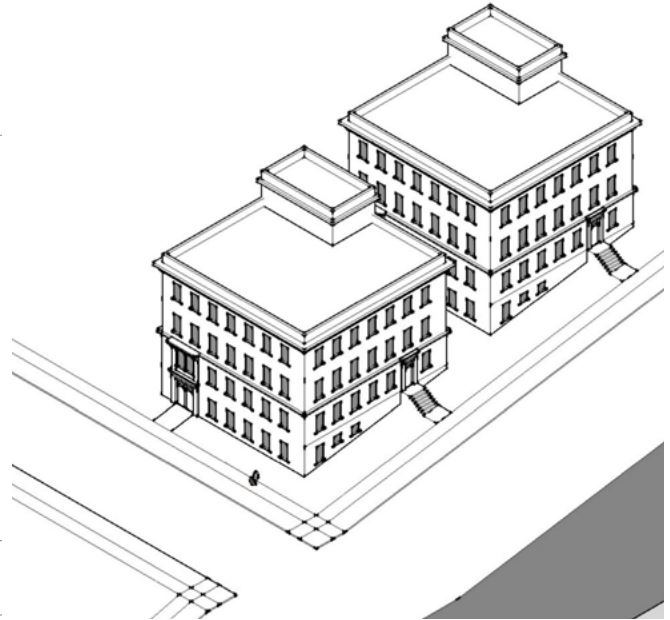
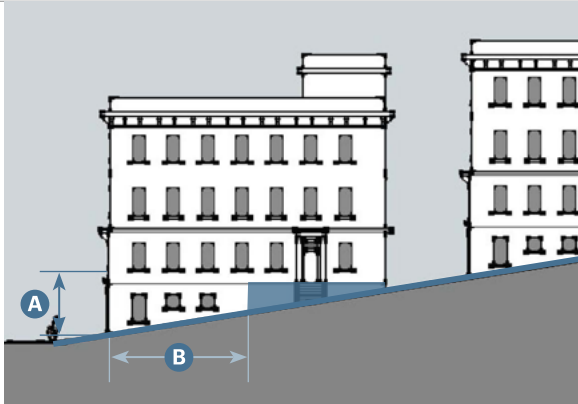

Slope is used to express a partial ground story with frontage and entries along adjacent street. **A**

Building footprint steps with slope through a partial ground story. **B**

**Not Allowed.** Grading that disconnects one or more new building façades from the adjacent public realm, resulting in retaining walls taller than four feet along a street or community open space.

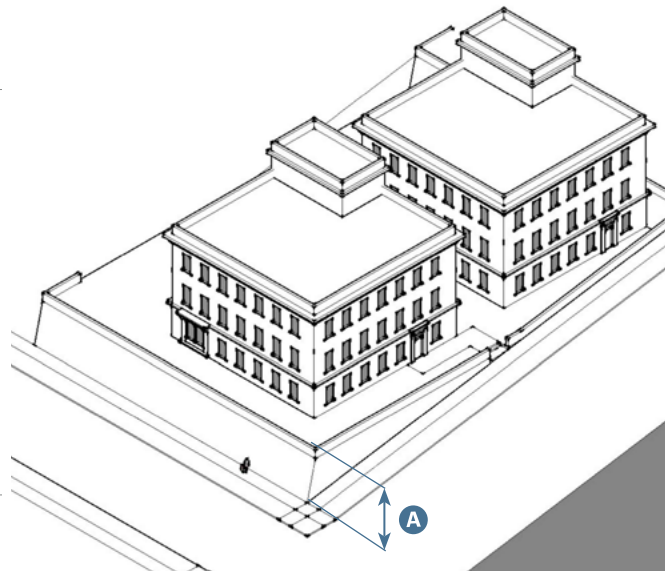
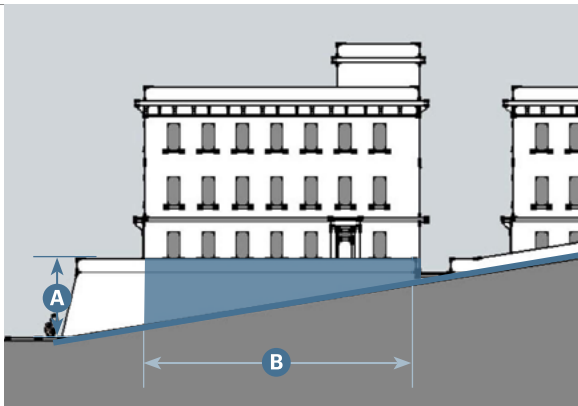

Height does not create building with frontage and entries along adjacent street; terraced design site is more than four feet from adjacent sidewalk/street/right-of-way. **A**

Building footprint does not step with slope. **B**



- C. **Topography and Required Location of Main Building.** Sloped topography can present issues with locating the main building on a design site in compliance with Chapter 25.02 (Zones), Subsection D (Building Placement) of the Zone. Chapter 25.07 (Exceptions) provides administrative exceptions for sloped topography.
- D. **Parking on Slopes.**
  - 1. Parking lot slopes shall not exceed five percent (after grading).
  - 2. Sloped topography can present issues with locating parking on a design site in compliance with Chapter 25.02 (Zones), Subsection E (Parking) of the Zone. Chapter 25.07 (Exceptions) provides administrative exceptions for parking location.
- E. **Grading or Regrading of Design Sites.** When existing design site topography is proposed to be changed, grading shall not result in any of the following:
  - 1. Creation of grade difference of more than four feet outside of any building footprint;
  - 2. Terraced design sites that result in a vertical difference of more than four feet between the adjacent right-of-way and the finished grade of the design site;
  - 3. Grading beyond the building pad and the required access drive;
  - 4. Cut exceeding 16 feet in height from top to toe;
  - 5. Cut slope exceeding two horizontal to one vertical;
  - 6. Graded slopes exceeding 30 percent;
  - 7. Graded slopes not contoured to blend with existing terrain, such that proposed cuts and fills exceed one foot of added/subtracted rise for each one and one-half feet of run;
  - 8. Graded slopes not screened from view under or behind buildings with landscape or natural topographic features; or
  - 9. Graded slopes not revegetated with a mixture of grass seed or shrubs as identified by *Chapter 22.10 (Vegetation Removal)* and *Chapter 22.85 (Erosion and Sedimentation Control Standards for Construction)*.
- F. **Sloped Parcels Measurement Methods.** The following methodology shall be used to identify slopes and steep slopes protected in compliance with this Section. An example of the methodology is shown in Figure 25.03.110.3 (Example for Defining Sloped and Steeply Sloped Design Sites). All areas not identified as steep slopes are considered "sloped".

**Figure 25.03.110.3: Example for Defining Sloped and Steeply Sloped Design Sites**

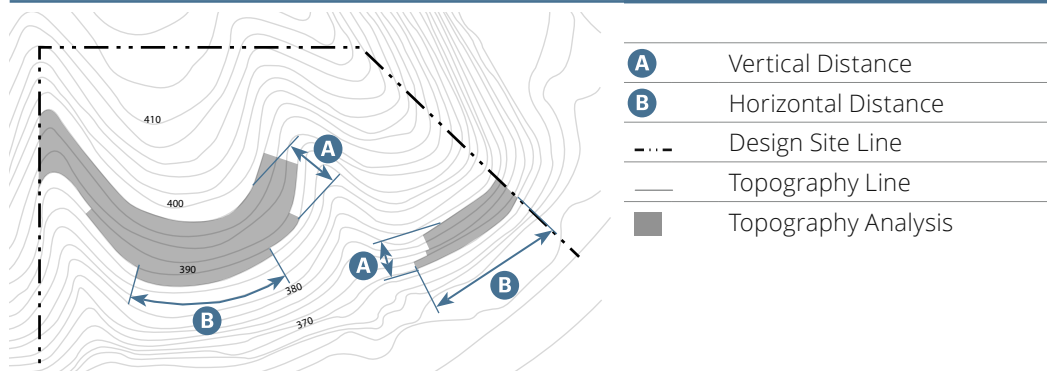

1. Use the methodology of *Section 30.15.030 (Determining Average Slope)* to calculate slopes.
2. To qualify as a steep slope, the slope shall be over 10 percent average with a 10-foot vertical drop over a 100-foot horizontal distance parallel to at least one common contour line. The horizontal measurement shall cross property lines to establish if a steep slope may exist on a design site (i.e., the 100-foot minimum width calculation shall cross a property line if necessary to Area Calculation). Steep slope areas are calculated based on the linear feet (horizontal distance) of steep slope on the design site.
  - (a) First, calculate the linear feet of slopes with the greatest percentage from Table 25.03.110.A (Maximum Amount of Sloped Areas Allowed to be Developed) for the design site size. Determine the square footage of each area as well as the sum of these areas for the total site.
3. Based on the calculations in Subsection 25.03.110.F.2, above, Table 25.03.110.A (Maximum Amount of Sloped Areas Allowed to be Developed) shows the percentage of slope area that is allowed to be developed. The steep slope areas to be undeveloped shall be included in the survey.

Table 25.03.110.A: Maximum Amount of Sloped Areas Allowed to be Developed		
Portions of Existing Slope	Design Site Size	
	Less than 1 acre	1+ acres
0-5.99%	100% max.	100% max.
6-9.99%	100% max.	70% max.
10-14.99%	100% max.	50% max.
15-19.99%	75% max.	25% max.
20-29.99%	25% max.	5% max.
> 30%	0% max.	0% max.

Figure 25.03.110.4: Example for a Sloped Design Site (<1 acre)

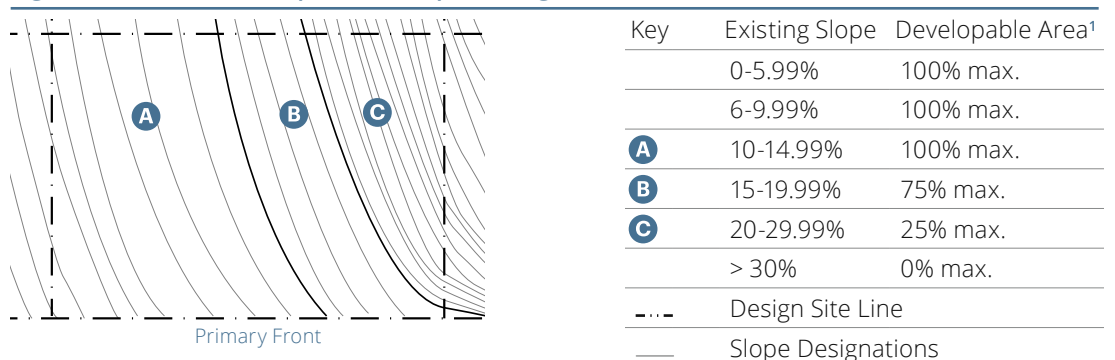

<sup>1</sup>In compliance with the setbacks of the zone, required community open space, this Section, and the maximum building footprint standards in Chapter 25.04 (Building Types).

---

## 25.03.120 Retaining Walls

- A. **Intent.** These standards are designed to minimize visual intrusion of retaining walls with requirements for length, height, and elements to reduce perception of height and bulk.
- B. **Grading.** Retaining walls shall be in compliance with developable area on sloped parcels in Section 25.03.110 (Sloped Parcels).
- C. **Height.** The height of retaining walls shall be measured in compliance with *Subsection 30.15.090.B (Measuring the Height of Fences and Hedges)* and limited as follows.
1. Retaining walls within any front setback, façade zone, or publicly visible shall not exceed three feet in height.
  2. All other retaining walls shall not exceed six feet in height.
- D. **Design.** Retaining walls must:
1. Include buttress or pilasters spaced a minimum of six feet apart, for the full length of the wall, if over 50 feet in length;
  2. Include a landscape planter in front of the wall when not within the building. The planter shall be at least three feet deep measured perpendicular to the wall; and
  3. Be comprised of materials consistent with Chapter 25.06 (Architectural Design), Subsection Q (Materials) of the Architectural Style.
- E. **Terraced Retaining Walls.** In addition to the maximum heights as specified above, multiple terraced retaining walls, in compliance with *Subsection 30.15.090.B.1 (Multiple Fences and Hedges)*, shall also be limited to the following cumulative heights:
1. Fill Slope Retaining Walls. Measure no more than 12 cumulative feet as measured from the lowest finished grade to the top of the upper wall, with a single retaining wall being no more than six feet as measured from the lower finished grade to the top of wall; or
  2. Cut Slope Retaining Wall. Measure no more than 16 cumulative feet as measured from the lowest finished grade to the top of the upper wall, with a single retaining wall being no more than six feet as measured from the lower finished grade to the top of wall; and
  3. Have a minimum horizontal distance, as measured perpendicular to the walls, that is at least equal to the average height of the vertical walls; and
  4. Include landscape in the entire horizontal area between retaining walls in compliance with Section 25.03.050 (Landscape).

## 25.03.130 Privacy

- A. **Intent.** These standards are designed to locate upper-story windows, balconies, and decks to minimize loss of privacy for neighboring properties.
- B. **Windows/Glazed Openings.** All upper-story windows/glazed openings within 15 feet of an interior lot line must comply with one of the following:
1. A minimum sill height of 42 inches; or
  2. Window is placed at an angle of at least 30 degrees, measured perpendicular to the adjacent interior property line; or
  3. Oriented toward the front or rear of the building or offset horizontally at least 12 inches edge to edge so that they do not face directly opposite any existing upper-story window on an adjacent residential structure.
- C. **Landings, Decks, and Balconies.**
1. Facing Adjoining Property. Upper-story unenclosed landings, decks, and balconies greater than 20 square feet, that face or overlook the adjoining property, shall be located a minimum of 15 feet from the interior lot lines.
  2. Not Facing Adjoining Property. Upper-story unenclosed landings, decks, and balconies, that do not face or overlook the adjoining property due to orientation or topography, may be located at the minimum interior setback line if an architectural screening element such as enclosing walls, trellises, awnings, or perimeter planters with a five-foot minimum height is incorporated into the unenclosed landing, deck, or balcony.

**Figure 25.03.130.1: Sill Height Standards along Interior Lot Line**

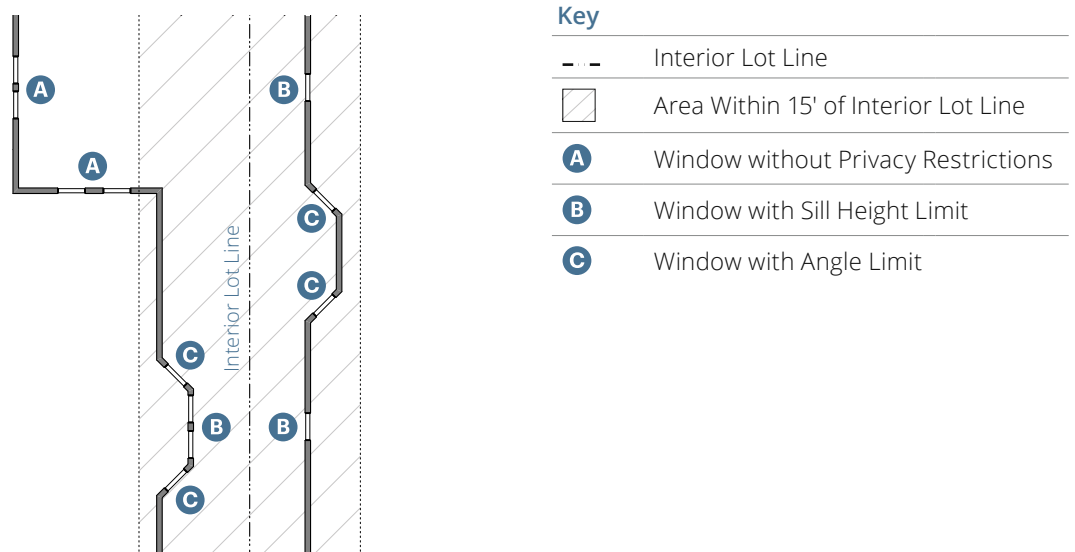

**25.03.140 Rooftop Decks**

- A. **Intent.** These standards are designed to provide functional outdoor space while minimizing visual, noise, and privacy impacts to surrounding properties and rights-of-way.
- B. **General Standards.**
  - 1. Rooftop decks are only allowed on block-scale buildings.
  - 2. Rooftop decks shall not be enclosed or covered, except with the following:
    - (a) Trellises can be 12 feet maximum in height, measured from floor-to-top of trellis.
    - (b) Guardrails, surrounding walls, or solid windscreens shall not exceed 42 inches in height. A transparent windscreen shall not exceed six feet in height.
  - 3. Materials for walls, trellis, pergola, windscreens, and lighting shall match those used for the main building.
- C. **Deck Placement.**
  - 1. Rooftop deck shall be located on roof of main building, not including cupolas or towers.
  - 2. Rooftop deck shall be located 15 feet minimum from building edge on primary and secondary front and 10 feet minimum from building edge on interior.
  - 3. The rooftop deck footprint shall be maximum of 25 percent of total roof area at level of rooftop deck.
  - 4. The finish floor deck height shall not exceed one foot above the roof surface.

**Figure 25.03.140.1: Rooftop Deck Placement and Elements**

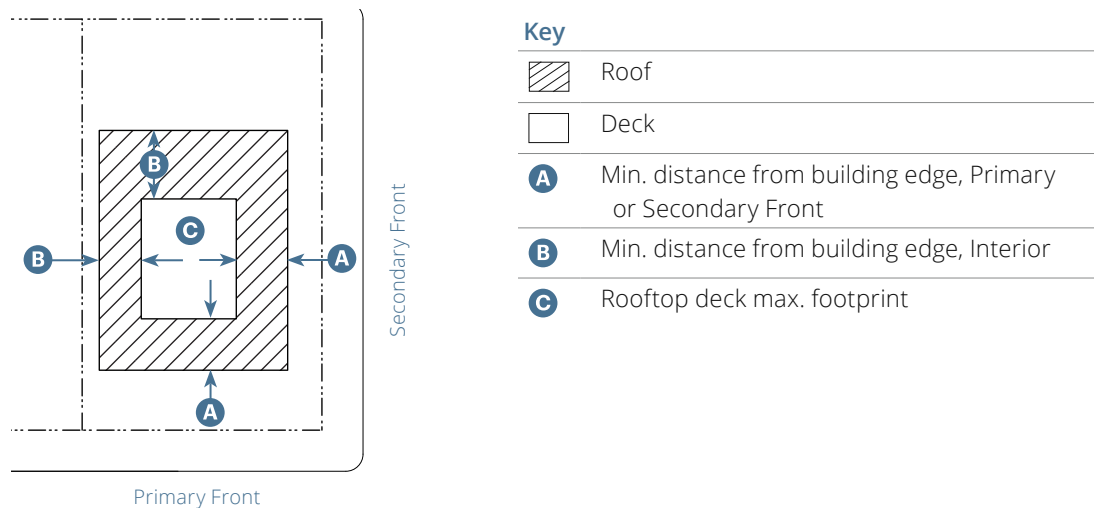

**D. Stair Penthouse, including Roof Hatches.**

1. Stair penthouses shall follow the rooftop deck setbacks from the building edge.
2. Overall height of stair penthouses shall be no greater than 10 feet. Stair penthouses are exempt from building height limitations, consistent with *Subsection 30.140.100.A (Architectural Elements)*.
3. The penthouse must be attached to the delineated area for the rooftop deck.
4. The penthouse shall be designed in the same style, materials, and finishes as the main building. See Chapter 25.06 (Architectural Design), Subsection Q (Materials) of the Architectural Style.

**E. Windscreen.**

1. Glass or other reflective materials used on windscreens or guardrails shall be oriented or treated to prevent glare that may affect streets, pedestrians, or surrounding structures.
2. Windscreens shall be located only within or along the edges of the maximum allowed area for the rooftop deck.

**F. Furniture and Elements.**

- (a) Furnishings (e.g., chairs, tables, stoves, barbecues, swimming pools, hot tubs) are allowed only within the delineated area for the rooftop deck.
- (b) Permanent items (such as pergola, trellis, shade devices, and/or swimming pools) are allowed.
- (c) Temporary items (such as fabric awnings and umbrellas) are not allowed.

**G. Compliance with Building and Fire Codes.** All rooftop decks shall be designed in compliance with building and fire safety requirements.

---

**25.03.150 Ground Surfaces and Paving**

**A. Intent.** This Section provides standards to support pedestrian-oriented development and improve the visual environment.

**B. Applicability.** Ground surfaces and paving are required for plazas, forecourts, courtyards, terraces, gateways, arcades, paseos, pedestrian pathways, and vehicle circulation areas.

1. Vehicular parking and circulation areas shall be paved in compliance with the *City's Access & Parking Design Standards*.
2. Paved public improvements shall comply with *Section 22.44.070 (Public Improvement Standards)*.

**C. Allowed Materials.**

1. Ground surfaces and paving may be brick, stone, colored and textured concrete, terra-cotta tile, or buff colored permeable pavers.
2. Pedestrian pathways may be untextured, poured concrete.
  - (a) Shared vehicle driveway and pedestrian pathways in the Side Court building type shall consist of a maximum 20 percent asphalt or untextured, poured concrete.

---

## 25.03.160 Large Site Standards

- A. **Intent.** This Section provides standards for development on large sites to ensure development delineates existing and proposed blocks, streets, and open space to preserve and enhance sense of place, provide opportunities for healthy living, increase connectivity and accessibility, add open space, and create a compact, walkable neighborhood. Streets within large sites are intended to generate one contiguous pedestrian network throughout the development site and adjacent public rights-of-way.
- B. **Applicability.**
1. Projects on sites of two or more acres shall set aside a minimum of 10 percent of the net developable lot area as community open space, in compliance with Subsection 25.03.160.D (Community Open Space).
  2. Projects on sites of four or more acres are subject to the requirements for a Sustainable Neighborhood Plan, in compliance with Subsection 25.03.160.C (Sustainable Neighborhood Plan).
- C. **Sustainable Neighborhood Plan (SNP).**
1. Each SNP shall show the proposed physical character of the development, in plan view:
    - (a) Boundaries of the proposed development;
    - (b) Existing and proposed blocks and streets within a 1,500 foot radius of the development boundaries, in compliance with Subsection 25.03.160.C.3 (Block and Street Standards);
    - (c) Existing trees and other natural features;
    - (d) New or modified community open space, in compliance with Section 25.03.160.D (Community Open Space);
    - (e) Proposed trees and landscape along streets and in community open spaces; and
    - (f) Identification of the proposed design sites, building types, and frontage types on each design site in compliance with the zone standards.
  2. Access and Visibility Standards. Public access and visibility is required in and along existing natural open spaces, including creeks and storm water management areas, and the community open space. These areas shall be fronted by:
    - (a) Single-loaded frontage streets (those with development on one side and open space on the other);
    - (b) Bike and pedestrian pathways; or
    - (c) Other methods of frontage that provide similar access and visibility to the open space, as zone standards allow, such as through public easements.
  3. Block and Street Standards.
    - (a) New blocks and streets shall be designed in compliance with the streets and roads standards pursuant to City Council Resolution No. 8096.
    - (b) Individual block lengths and the total block perimeter shall be in compliance with the standards in Table 25.03.160.A (Block Size Standards).
      - (1) An attached half-block is allowed to adjoin an existing half-block.

Table 25.03.160.A: Block Size Standards		
Block Length	Block Perimeter	Depth of Attached Half-Block <sup>1</sup>
500' max.	1,800' max.	Min. is min. design site depth for the selected building type for the zone; 250' max.

<sup>1</sup> Distance from street or right-of-way to shared property line

Figure 25.03.160.1: Block Size

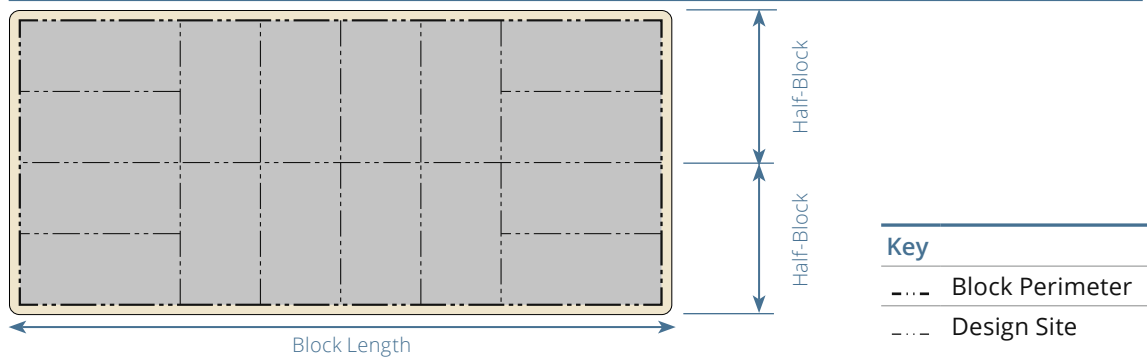

- (c) The new street network shall connect to the existing street network through multi-modal connections.
  - (1) New streets shall align with and continue existing or proposed streets by extending to or along adjoining property boundaries. New dead-end streets and cul-de-sacs are not allowed. See *Section 30.140.180 (Street Frontage and Access)*.
  - (2) New streets shall provide connecting pedestrian and bicycle routes to all adjacent public, non-limited-access right-of-ways, and dead-end streets.
  - (3) The pedestrian network shall be composed of sidewalks as provided in *Chapter 22.44 (Streets Dedication and Improvement Requirements for Building Permits)* and *Chapter 22.60 (Streets and Sidewalks)* and community open spaces as provided in Subsection 25.03.160.D (Community Open Space). The pedestrian network shall incorporate crosswalks as provided in *Chapter 10.32 (Crosswalks)* where pedestrian pathways intersect vehicular travel lanes.
- 4. Design Site Standards. New design sites shall be delineated in accordance with Section 25.02.040 (Design Sites) and the following standard:
  - (a) Design sites must front onto a street, pedestrian pathway, courtyard, or Community Open Space.
- 5. Building Types and Frontage Types Standards.
  - (a) The SNP shall maintain a mix of at least two different building types within each block, using only the types allowed in the zone. Half-blocks adjoining existing development are exempt from the requirement for mixed building types.
  - (b) Along each block face containing more than one building entrance, the SNP shall maintain a mix of at least two different frontage types, using only the types allowed in the zone.
- 6. Revisions to a SNP. As individual needs of a development may change over time, a request for a change to the approved building types specified in the SNP may be made in compliance with the zone standards. Such request shall require approval by the original Review Authority and shall be processed in the same manner as the original approval.



Figure 25.03.160.2: Sustainable Neighborhood Plan Design Process Overview

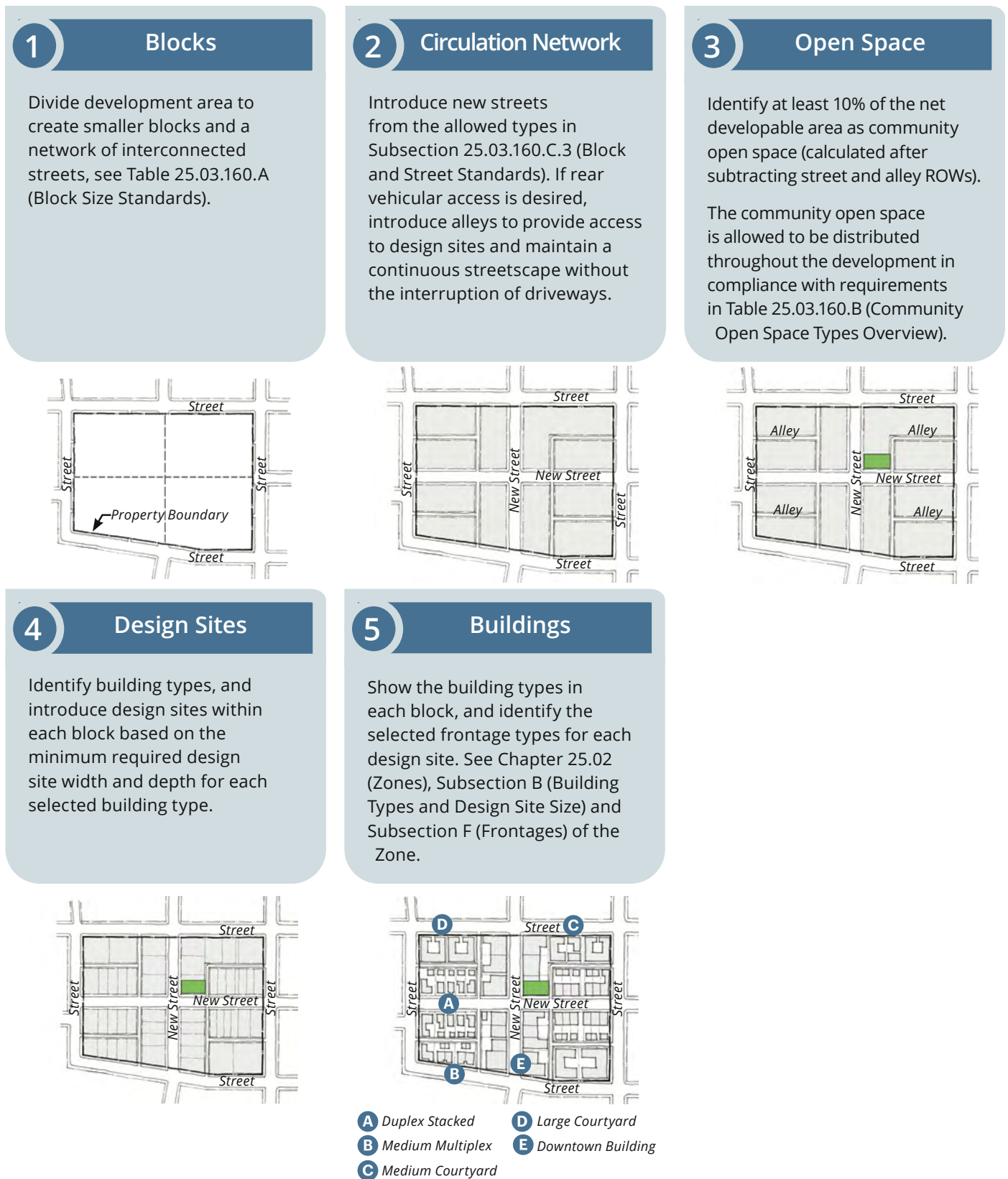

D. **Community Open Space.** Community open spaces provide pedestrian-oriented amenities in connection with the City's established network of pedestrian facilities and open spaces; promote the health benefits of walkable environments; and reinforce the unique identity of Santa Barbara.

1. One or more community open spaces shall be used to satisfy the minimum community open space area requirement, in compliance with Table 25.03.160.B (Community Open Space Types Overview).

Table 25.03.160.B: Community Open Space Types Overview						
	Specific Standards	Zones				
		NM	NL	MUC	DE	DC
Green	25.03.160.D.6	A	A	A	—	—
Plaza	25.03.160.D.7	—	—	—	A	A
Paseo	25.03.160.D.8	A	A	A	A	A
<b>Key</b>	A = Allowed		— = Not Allowed			

2. Public access and visibility are required in and along community open spaces. Community open spaces may be closed after business hours or at night consistent with City park hours of operation.
3. Colors, materials of outdoor furniture, and barriers shall be in compliance with Chapter 25.06 (Architectural Design), Subsection Q (Materials) of the Architectural Style.
4. Hardscape areas and pedestrian pathways shall be in compliance with Section 25.03.150 (Ground Surfaces and Paving).
5. All community open spaces shall be on grade and shall be level with the right-of-way and not enclosed with fences or other obstructions.
6. Green. A mostly landscaped area to provide access to shade, resting areas, and plants within the built environment.
  - (a) A Green must be a minimum of 3,000 square feet with one dimension at least 50 feet. At least one entire side of the Green shall abut and be accessible from the right-of-way.
  - (b) More than 50 percent shall consist of landscape in compliance with Section 25.03.050 (Landscape) with pedestrian pathways.
  - (c) Up to 50 percent of the area may double as storm water retention.
  - (d) Shade from canopy trees or trellis and seating must be provided.
7. Plaza. A mostly hardscaped area that provides pedestrians a gathering space away from the street.
  - (a) A Plaza must be a minimum of 2,500 square feet in area with a minimum 30 feet clear dimension in length and width.
  - (b) The Plaza shall be accessible from the sidewalk, Paseo, or Gateway.
  - (c) Pedestrians shall be separated from adjacent vehicular activity by any combination of at least two of the following: walls up to 30 inches tall, landscape, street furniture, curbside parking.
  - (d) A minimum of 50 percent of the Plaza must be hardscape area and a minimum of ten percent landscape area, in the ground or as potted plants.
  - (e) Seating must be provided as individual or group seating.

8. Paseo. A part of a network of pedestrian pathways that extend from the public right-of-way. The pedestrian pathway is lined by shopfronts or residential ground floors and pedestrian entries as required by the zone.
  - (a) A Paseo must be a minimum of 12 feet wide between buildings, or through buildings as a breezeway, with an 8 foot minimum unobstructed through pedestrian pathway, and a minimum of 8 feet vertical clearance.
  - (b) A Paseo may be up to 150 feet long. A Paseo length may be unlimited if extending from one public sidewalk or community open space to another.
  - (c) Paseos are required to connect from a street to another street, to a public parking lot, or to community open space.
  - (d) An entrance transition to the Paseo is required, through an entry arch, accent paving, signage, or Gateway.
  - (e) No more than 25 percent of the Paseo surface may consist of untextured poured concrete.
  - (f) A minimum of 10 percent of the Paseo must be landscape, in the ground or as potted plants.
  - (g) Paseos are required on any project that includes an area identified as a proposed or future paseo connection on the City's Paseos Plan Maps in the Pedestrian Master Plan.
  - (h) Edges of the Paseo must be lined by ground floor façades in compliance with façade zone in Chapter 25.02 (Zones), Subsection D (Building Placement) of the Zone or frontages allowed in Chapter 25.02 (Zones), Subsection F (Frontages) of the Zone.
  - (i) Paseos shall not include trash enclosures or public utility equipment.
  - (j) Paseos may include benches/seating, awnings, outdoor dining, or other elements to activate that do not infringe on the unobstructed pedestrian pathway.
    - (1) Areas within the public right-of-way proposed for outdoor dining are required to be in compliance with *Chapter 9.95 (Use of City Sidewalks and Rights-of-Way for Dining Purposes)*.

*This page intentionally left blank*

# Chapter 25.04 Building Types

---

## Sections:

25.04.010	Purpose
25.04.020	Overview
25.04.030	General Requirements
25.04.040	Allowed Building Types
25.04.050	Duplex Side-by-Side
25.04.060	Duplex Stacked
25.04.070	Cottage Court
25.04.080	Medium Multiplex
25.04.090	Duplex Court
25.04.100	Side Court
25.04.110	Medium Courtyard
25.04.120	Large Multiplex
25.04.130	Large Courtyard
25.04.140	Downtown Building
25.04.150	Massing Types
25.04.160	Massing and Façade Composition
25.04.170	Adjacency and Height Standards

---

## 25.04.010 Purpose

This Chapter provides the standards for development of main building types that can be developed using the ODDS. The building type options are selected to maintain the existing and intended physical character of each zone, offer housing choices and affordable housing opportunities, and encourage a mix of land uses to include retail and workplace centers, residential living in commercial centers with easy access to grocery stores and recreation, connectivity and civic engagement, and public space for pedestrians.

---

## 25.04.020 Overview

- A. Building types are used to articulate size, scale, and massing according to the intent of each zone.
- B. Building types are categorized into two groups: House-Scale Buildings and Block-Scale Buildings. See Figure 25.04.020.1 (Examples of House-Scale and Block-Scale Buildings).
  1. House-Scale Buildings. Buildings with the appearance of a single-unit house and scaled to fit within low-to-moderate intensity neighborhoods. House-scale buildings are up to 30 feet in height, ranging in width and depth from 32 feet up to 130 feet on deeper lots.
  2. Block-Scale Buildings. Buildings that individually, or when arranged together, comprise a typical City block. They are scaled to fit within moderate-to-high intensity neighborhoods, standing up to 48 feet in height, and ranging in width and depth from 60 feet up to 200 feet.

Figure 25.04.020.1: Examples of House-Scale and Block-Scale Buildings

**House-Scale Buildings**

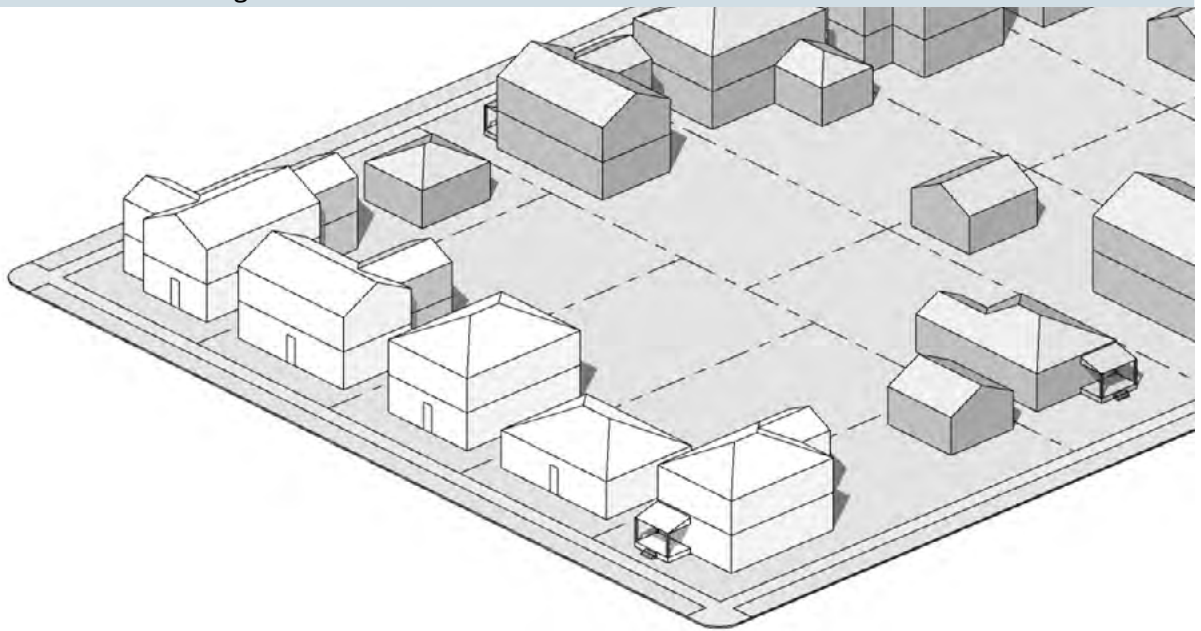

**Block-Scale Buildings**

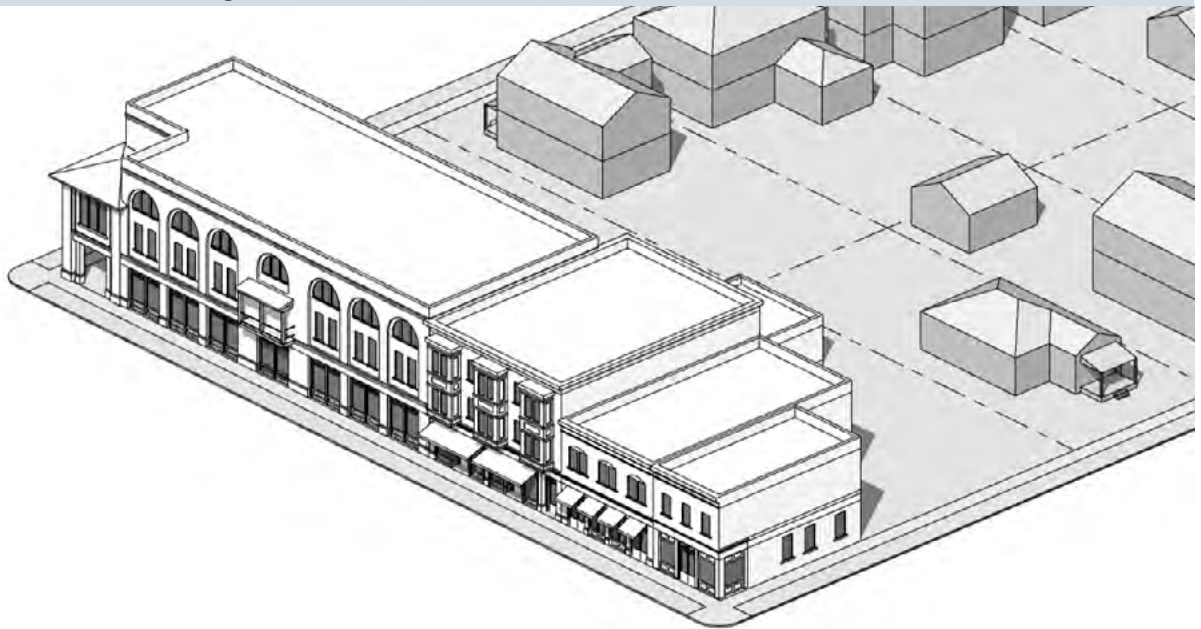

---

## 25.04.030 General Requirements

- A. **Main Buildings on a Design Site.** Each design site shall have only one main building, except as follows, in compliance with the standards:
1. The Cottage Court (Section 25.04.070) may consist of up to nine individual buildings;
  2. The Duplex Court (Section 25.04.090) may consist of up to three individual buildings;
  3. The Side Court (Section 25.04.100) may consist of up to two buildings;
  4. The Medium Courtyard (Section 24.04.110) may consist of up to two buildings; and
  5. The Large Courtyard (Section 25.04.130) may consist of up to two buildings.
- B. **Design.** Buildings shall be designed in compliance with Chapter 25.06 (Architectural Design).
- C. **Pedestrian Access.** Pedestrian pathways must connect each unit or building to the right-of-way and on-site parking in compliance with Chapter 25.04 (Building Types), Subsection D (Pedestrian Access) of the Building Type and the *City's Access & Parking Design Standards*. Lots with multiple design sites may share pedestrian pathways.
- D. **Open Yard.** Open yard shall be designed in compliance with Section 25.03.040 (Open Yards).
- E. **Parking.** Parking shall be designed and located in compliance with Section 25.03.100 (Parking Techniques). Parking may be designed as uncovered (surface) or covered (individual detached or attached garage/carport, tuck-under, podium, subterranean), in compliance with the setbacks in Chapter 25.02 (Zones), Subsection E (Parking) of the Zone.
- F. **Wings.** Wings are a secondary component of building form that allow the overall building footprint to increase beyond the maximum size of the main body. To further this objective, the standards identify specific requirements for wings:
1. Wings shall be less in length than the main body;
  2. Wings that are aligned with the façade of the main body shall be one-story less in height than the main body; and
  3. Wings that are offset from the façade plane of the main body by at least five feet are allowed at the same height as the main body.
- G. **Density.** The number of units identified for each building type is dependent on the design site being large enough to accommodate all the zone's standards (e.g., parking). The total number of units is as allowed by the General Plan maximum density. See Section 25.02.030 (General Requirements).

**H. Measuring Building Types.**

1. Main Body. The width and depth of the main body shall be measured as follows:
  - (a) The width shall be parallel to the primary front in compliance with the façade zone requirements.
  - (b) The depth shall be perpendicular to the primary front.

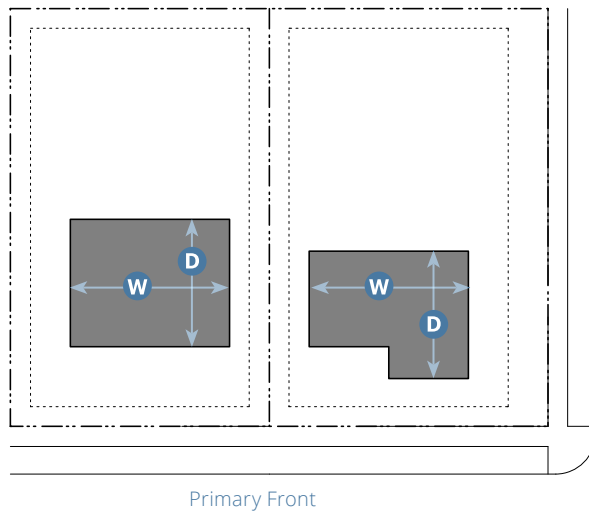

**Figure 25.04.030.1:  
Main Body**

- W** Width
- D** Depth

2. Wings. The width and depth of wings shall be measured as follows:
  - (a) The width shall be the greater of the two dimensions of the footprint.
  - (b) The depth shall be the lesser of the two dimensions of the footprint.

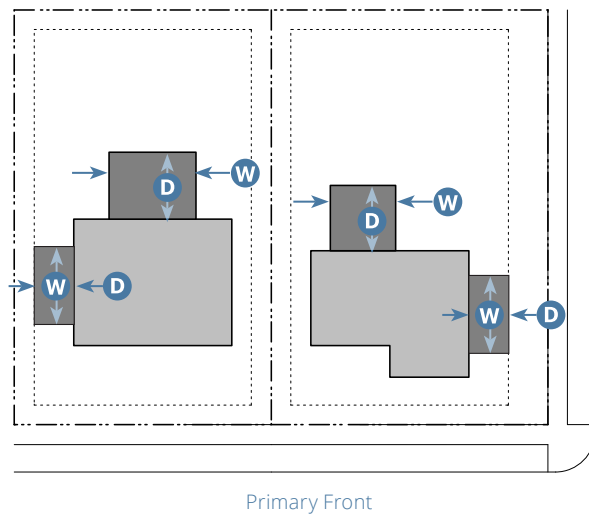

**Figure 25.04.030.2:  
Wings**

- W** Width
- D** Depth



## 25.04.040 Allowed Building Types

Table 25.04.040.A (Building Types Overview) provides an overview of the allowed building types in each zone. The house-scale buildings allowing in the Neighborhood Medium (NM) and Neighborhood Large (NL) zones are also allowed in Mixed-Use Corridor (MUC), Downtown Edge (DE), and Downtown Core (DC) zones subject to design site dimensions and all other standards for those building types.

Table 25.04.040.A: Building Types Overview						
	Specific Standards	Zones				
		NM	NL	MUC	DE	DC
<b>House-Scale</b>						
Duplex Side-by-Side	25.04.050	A	A	A	A	A
Duplex Stacked	25.04.060	A	A	A	A	A
Cottage Court	25.04.070	A	A	A	A	A
Medium Multiplex	25.04.080	A	A	A	A	A
Duplex Court	25.04.090	A	A	A	A	A
Side Court	25.04.100	—	A	A	A	A
Medium Courtyard	25.04.110	—	A	A	A	A
<b>Block-Scale</b>						
Large Multiplex	25.04.120	—	—	A	A	A
Large Courtyard	25.04.130	—	—	A	A	A
Downtown Building	25.04.140	—	—	—	—	A
<b>Key</b>		A = Allowed		— = Not Allowed		

25.04.050 Duplex Side-by-Side



Local example in the West Downtown neighborhood



Local Example in the Oak Park neighborhood



Local Example in the West Beach neighborhood

**A. Description**

A small-to-medium-sized, detached, House-Scale Building. The building consists of two side-by-side units, both facing the street and within a single building massing. The type has the appearance of a single-unit house and is scaled to fit within lower-intensity neighborhoods.

**B. Number of Units/Buildings**

Units per Building	2 max.
Buildings per Design Site	1 max.

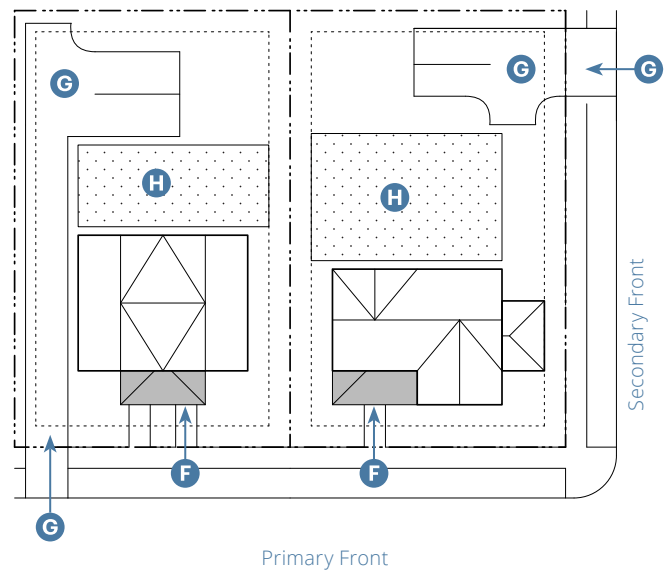
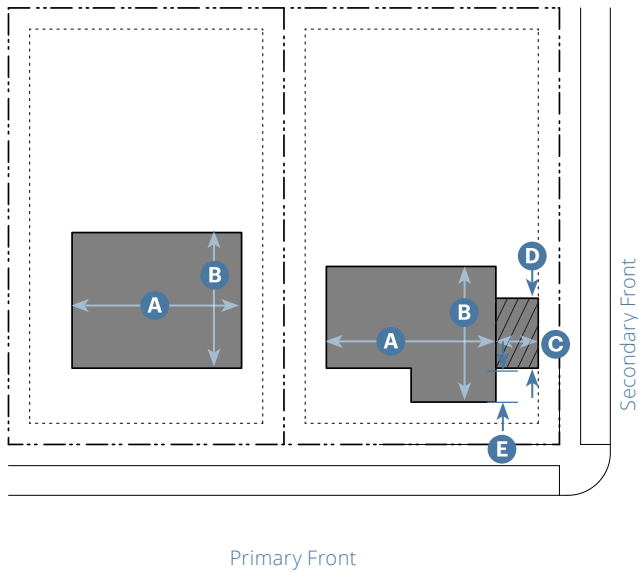

**Key**

- - - Lot/Design Site Line
- ..... Building Setback Line
- Building
- ▨ Wing

**C. Building Size and Massing**

Height	
Stories	2.5 max.
Main Body	
Width	48' max. <b>A</b>
Depth	36' max. <b>B</b>
Wings	
Width	15' max. <b>C</b>
Depth	24' max. <b>D</b>
Separation between Wings	10' min.
Offset from Main Body façade plane along primary front, secondary front, or community open space	5' min. if 2 stories; <b>E</b> 0' min. if 1 story
Massing Types	
Wide Bar	Table 25.04.150.A.2
"L" Courtyard	Table 25.04.150.A.3
Wide "T"	Table 25.04.150.A.4
"U" Courtyard	Table 25.04.150.A.5

**Key**

- - - Lot/Design Site Line
- ..... Building Setback Line
- Frontage
- ▨ Common Open Yard

**D. Pedestrian Access**

Main Entrance Location Primary Front **F**

Each unit shall have an entry facing the street on or within 25' of the front façade.

On corner design sites, each unit shall front a different street.

**E. Vehicle Access and Parking**

Driveway and parking location shall comply with standards in Chapter 25.02 (Zones), Subsection E (Parking) of the Zone. **G**

Parking may be surface or garage/carport as allowed by the zone.

**F. Open Yard**

Open yard shall comply with standards in Section 25.03.040 (Open Yards). **H**

**25.04.060 Duplex Stacked**



*Local example in the West Beach neighborhood*



*Local example in the West Beach neighborhood*



*Local example in the West Beach neighborhood*

**A. Description**

A small-to-medium-sized, detached, House-Scale Building. The building consists of two stacked units, both facing the street and within a single building massing. The type has the appearance of a single-unit house and is scaled to fit within lower-intensity neighborhoods.

**B. Number of Units/Buildings**

Units per Building	2 max.
Buildings per Design Site	1 max.

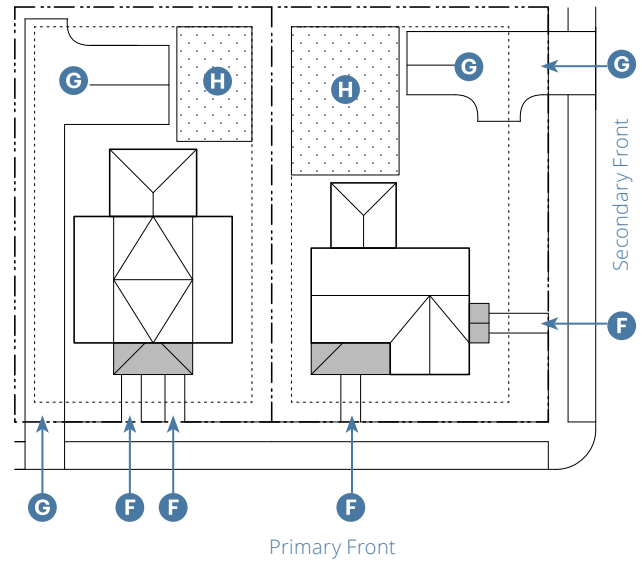
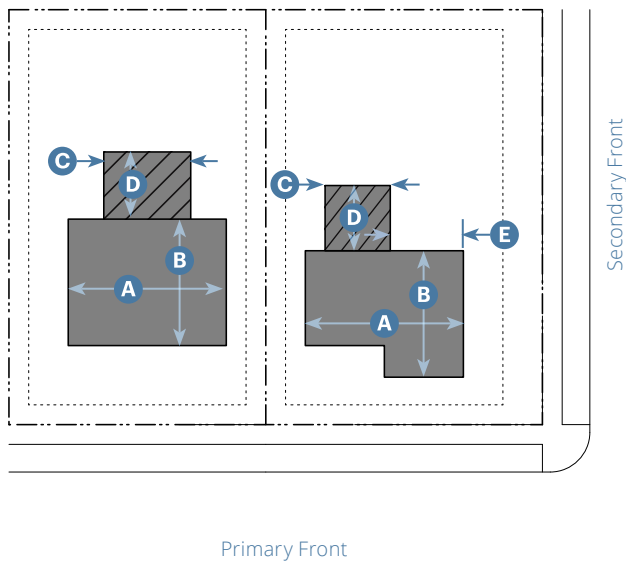

**Key**

- - - Lot/Design Site Line
- ..... Building Setback Line
- Building
- ▨ Wing

**C. Building Size and Massing**

**Height**

Stories 2.5 max.

**Main Body**

Width 36' max. (A)

Depth 48' max. (B)

**Wings**

Width 15' max. (C)

Depth 24' max. (D)

Separation between Wings 10' min.

Offset from Main Body façade plane along primary front, secondary front, or community open space 5' min. if 2 stories; 0' min. if 1 story (E)

**Massing Types**

Narrow Box	Table 25.04.150.A.1
Wide Bar	Table 25.04.150.A.2
"L" Courtyard	Table 25.04.150.A.3

**Key**

- - - Lot/Design Site Line
- ..... Building Setback Line
- Frontage
- ▨ Common Open Yard

**D. Pedestrian Access**

Main Entrance Location Primary Front (F)

Each unit shall have an entry facing the street on or within 25' of the front façade.

On corner design sites, each unit shall front a different street.

**E. Vehicle Access and Parking**

Driveway and parking location shall comply with standards in Chapter 25.02 (Zones), Subsection E (Parking) of the Zone. (G)

Parking may be surface or garage/carport.

**F. Open Yard**

Open yard shall comply with standards in Section 25.03.040 (Open Yards). (H)

**25.04.070 Cottage Court**



*Local example in West Beach neighborhood*



*Local example in the Upper East neighborhood*



*Local example in the Laguna neighborhood*

**A. Description**

A group of up to nine small, detached, House-Scale Buildings arranged to define a shared court open to and visible from the street. The shared court is common open yard, thus becoming an important community-enhancing element. The type is scaled to fit within low-to-moderate-intensity neighborhoods and in nonresidential contexts.

**B. Number of Units/Buildings**

Units per Building	1 max.
Total Buildings per Design Site	3 min.; 9 max. <sup>1</sup>

<sup>1</sup> The rearmost Cottage may contain up to 2 units, for a total of 10 units.

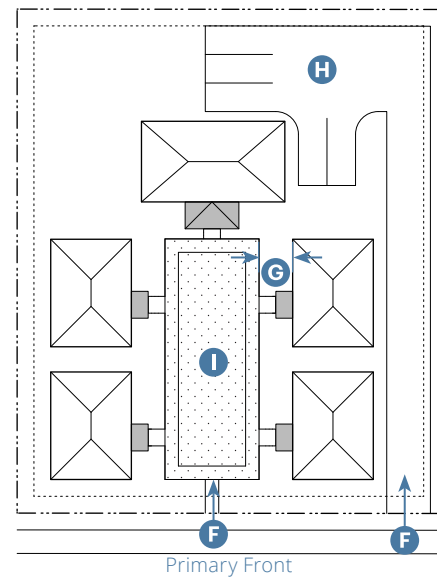
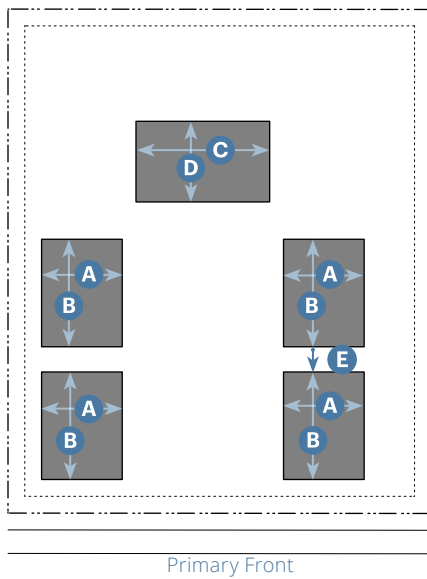

**Key**

- - - Lot/Design Site Line
- ..... Building Setback Line
- Building

**C. Building Size and Massing**

<b>Height</b>	
Stories	1.5 max. <sup>2</sup>
<b>Main Body (per Cottage)</b>	
Width	32' max. <b>(A)</b>
Depth	32' max. <b>(B)</b>
Width, Rearmost Building	48' max. <b>(C)</b>
Depth, Rearmost Building	36' max. <b>(D)</b>
Separation between Buildings	10' min. <b>(E)</b>
<b>Wings</b>	
Not Allowed	
<b>Massing Types (per Cottage)</b>	
Narrow Box	Table 25.04.150.A.1
"L" Courtyard	Table 25.04.150.A.3

<sup>2</sup>The rearmost Cottage may be 2.5 stories max.

**D. Pedestrian Access**

Main Entrance Location	Shared Court <sup>3</sup>
Shared court must be accessible from primary front.	<b>(F)</b>
Pedestrian Pathway Setback from Bldg. Entry	5' min. <b>(G)</b>

A pedestrian pathway must connect all unit main entrances to either shared court or right-of-way.

**Key**

- - - Lot/Design Site Line
- ..... Building Setback Line
- Frontage
- Common Open Yard

**D. Pedestrian Access(Continued)**

**Frontage Area along Common Open Yard**

Frontages shall not encroach into the shared court.

<sup>3</sup> Design sites on a corner may have unit entrances on the secondary front.

**E. Vehicle Access and Parking**

Driveway and parking location shall comply with standards in Chapter 25.02 (Zones), Subsection E (Parking) of the Zone. **(H)**

Parking may be surface or garage/carport.

Spaces may be individually accessible by the units and/or common parking areas at interior of design site.

**F. Open Yard**

Open yard shall comply with standards in Section 25.03.040 (Open Yards). **(I)**

**G. Fencing**

Fencing only allowed around or between individual buildings. Fences shall not bisect the shared court or exceed 42" height. Fence materials shall be in compliance with the materials for the style.

25.04.080 Medium Multiplex



Local example in the Upper East neighborhood



Local example in the West Beach neighborhood



Local example in the Oak Park neighborhood

**A. Description**

A small-to-medium-sized, detached, House-Scale Building that consists of three to four stacked units, typically with one shared entry or individual entries along the primary front. The type has the appearance of a single-unit house and is scaled to fit within low-to-moderate-intensity neighborhoods.

**B. Number of Units/Buildings**

Units per Building	3 min., 4 <sup>1</sup>
Main Buildings per Design Site	1 max.

<sup>1</sup> Up to the maximum number of units allowed by General Plan density.



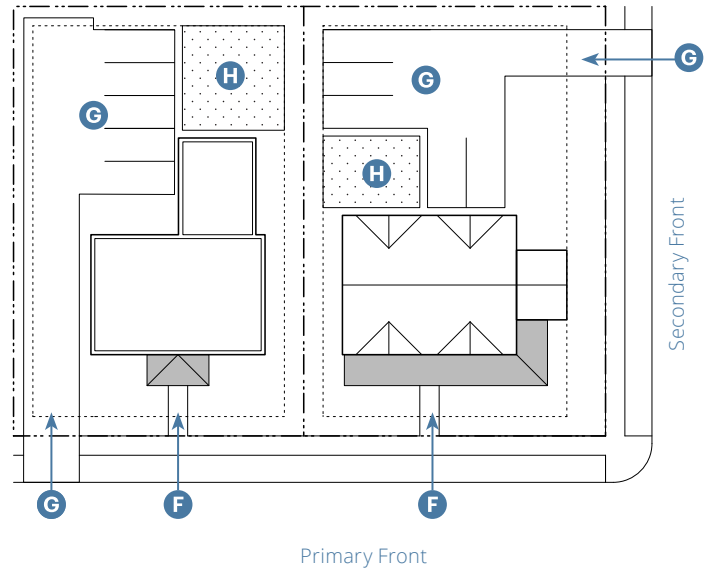
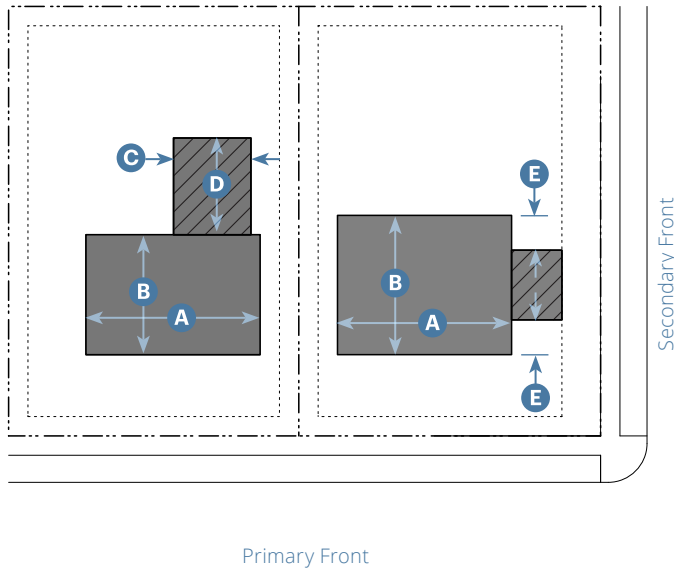

**Key**

- - - Lot/Design Site Line
- ..... Building Setback Line
- Building
- ▨ Wing

**C. Building Size and Massing**

**Height**

Stories 2.5 max.

**Main Body**

Width 48' max. **(A)**

Depth 48' max. **(B)**

**Wings**

Width 15' max. **(C)**

Depth 24' max. **(D)**

Separation between Wings 10' min.

Offset from Main Body façade plane along primary front, secondary front, or community open space 5' min. if 2 stories; 0' min. if 1 story **(E)**

**Massing Types**

Narrow Box	Table 25.04.150.A.1
Wide Bar	Table 25.04.150.A.2
"L" Courtyard	Table 25.04.150.A.3
"U" Courtyard	Table 25.04.150.A.5

**Key**

- - - Lot/Design Site Line
- ..... Building Setback Line
- Frontage
- ▨ Common Open Yard

**D. Pedestrian Access**

Main Entrance Location Primary Front<sup>2</sup> **(F)**

Each unit may have an individual entry.

<sup>2</sup> Design sites on a corner may have unit entrances on the secondary front only if min. 50% individual units accessed from the primary front.

**E. Vehicle Access and Parking**

Driveway and parking location shall comply with standards in Chapter 25.02 (Zones), Subsection E (Parking) of the Zone. **(G)**

Parking may be surface, garage/carport, or tuck-under.

**F. Open Yard**

Open yard shall comply with standards in Section 25.03.040 (Open Yards). **(H)**

25.04.090 Duplex Court



Local example in the Oak Park neighborhood



Local example in the Laguna neighborhood



Local example in the Laguna neighborhood

**A. Description**

A group of small, detached House-Scale duplex buildings which may be added to one or more existing buildings on the lot. The new buildings are arranged to define a shared court. The shared court is common open yard. The type is scaled to fit within low-to-moderate intensity neighborhoods.

**B. Number of Units/Buildings**

Units per Building	2 max.
Total Buildings per Design Site	2 min., 3 max.

**C. Building Size and Massing**

**Height**

Stories	2.5 max.
---------	----------

**Main Body (per Building)**

Width	48' max.	<b>B</b>
Depth	48' max.	<b>C</b>
Separation between Buildings	10' min.	

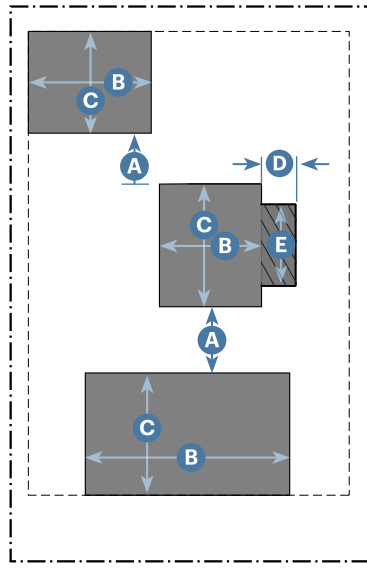

Primary Front

**Key**

- - - Lot/Design Site Line
- - - - Building Setback Line
- Building
- ▨ Wing

**C. Building Size and Massing (Continued)**

Wings		
Width	15' max.	<b>D</b>
Depth	24' max.	<b>E</b>
Separation between Wings	10' min.	
Offset from Main Body	5' min. if 2 stories;	
Façade plane along primary front, secondary front, or community open space	0' min. if 1 story	

**Massing Types (per Building)**

Narrow Box	Table 25.04.150.A.1
Wide Bar	Table 25.04.150.A.2
"L" Courtyard	Table 25.04.150.A.3
"U" Courtyard	Table 25.04.150.A.5

**D. Pedestrian Access**

Pedestrian Pathway Setbacks	5'	<b>F</b>
The frontmost building shall be accessed from the primary front.		

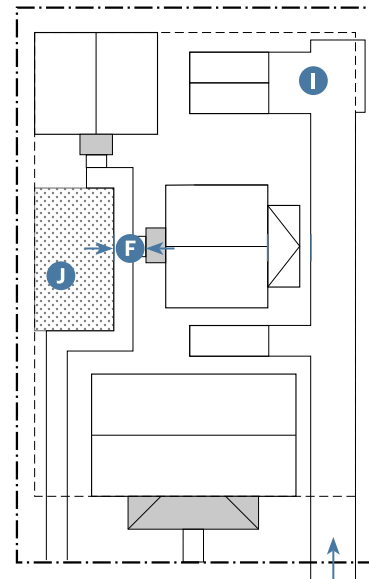

Primary Front

**Key**

- - - Lot/Design Site Line
- - - - Building Setback Line
- Frontage
- ▨ Common Open Yard

**D. Pedestrian Access (Continued)**

All buildings not fronting a street must front the shared court; except that design sites on a corner may have unit entrances on the secondary front. All buildings fronting the shared court must provide a frontage type along and take access from the shared court.

Pedestrian pathways must connect directly to the right-of-way, be visually or physically separate from vehicular circulation (may occur on same surface), and shall not bisect the shared court.

**Frontage Area along Common Open Yard**

Frontages shall not encroach into the shared court.

**E. Vehicle Access and Parking**

Driveway and parking location shall comply with standards in Chapter 25.02 (Zones), Subsection E (Parking) of the Zone. **I**

Parking may be surface, garage/carport, or tuck-under.

**F. Open Yard**

Open yard shall comply with standards in Section 25.03.040 (Open Yards). **J**

25.04.100 Side Court



Local example in the Laguna neighborhood



Local example in the Westside neighborhood



Local example in the Laguna neighborhood

**A. Description**

A House-Scale Building fronting a shared pedestrian pathway and vehicular driveway with decorative paving. The foremost units face the street. This type is intended for narrow and deep parcels and is typically located within low-to-moderate-intensity neighborhoods.

**B. Number of Units/Buildings**

Units per Building	8 <sup>1</sup>
Total Buildings per Design Site	2 max.

<sup>1</sup> Up to the maximum number of units allowed by General Plan density.

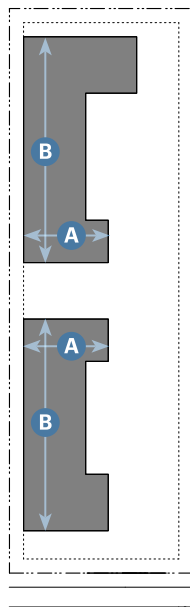

Primary Front

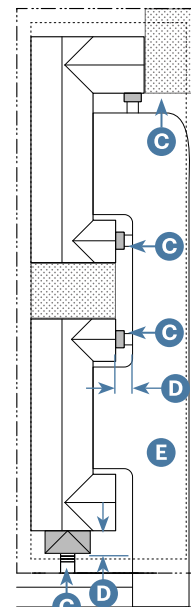

Primary Front

**Key**

- - - Lot/Design Site Line
- Building
- ..... Building Setback Line

**C. Building Size and Massing**

Height	NL	MUC; DE
Stories	2.5 max. <sup>2</sup>	3 max.

<sup>2</sup> Up to 1/2 of each building footprint is allowed up to 3 stories, if located at least 35' behind the primary front façade.

**Main Body (per Building)**

Width	48' max.	<b>A</b>
Overall Length	60' max. 80' max.	<b>B</b>
Separation between Buildings	10' min.	

**Wings**

Not Allowed

**Massing Types (per Building)**

Narrow Box	Table 25.04.150.A.1
"L" Courtyard	Table 25.04.150.A.3
"U" Courtyard	Table 25.04.150.A.5

At least 50% of ground floor space shall be occupiable.

**Key**

- - - Lot/Design Site Line
- Frontage
- ..... Building Setback Line
- ▨ Shared Vehicle Access

**D. Pedestrian Access**

Pedestrian pathway shall be visually or physically delineated from vehicular access (may occur on same surface). The frontmost unit shall be accessed from the primary **C** front; other units shall be accessed from the shared vehicle access area.

Each primary entrance shall include a frontage type, as **D** allowed in the Zone, within an area at least 7' deep.

**E. Vehicle Access and Parking**

Driveway and parking location shall comply with standards in Chapter 25.02 (Zones), Subsection E (Parking) of the Zone.

Parking may be surface, garage/carport, or tuck-under.

**Shared Vehicular Access Area **E****

Width	20' min. (building façade to property line)
Depth	Up to rearmost building, in compliance with fire access requirements.

**F. Open Yard**

Open yard shall comply with standards in Section 25.03.040 (Open Yards).

25.04.110 Medium Courtyard



Local example in the Laguna neighborhood



Local example in the West Downtown neighborhood



Local example in the Laguna neighborhood

**A. Description**

A detached, House-Scale Building that consists of up to 18 attached or stacked units, accessed from a shared courtyard. The shared courtyard is common open yard. The type is typically integrated in low-to-moderate-intensity neighborhoods.

**B. Number of Units/Buildings**

	NL; MUC	DE
Units per Building	15 <sup>1</sup>	18 <sup>1</sup>
Buildings per Design Site	———2 max.———	

<sup>1</sup> Up to the maximum number of units allowed by General Plan density.

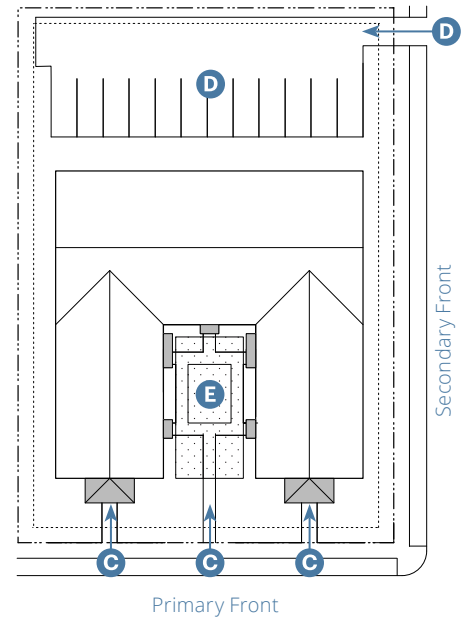
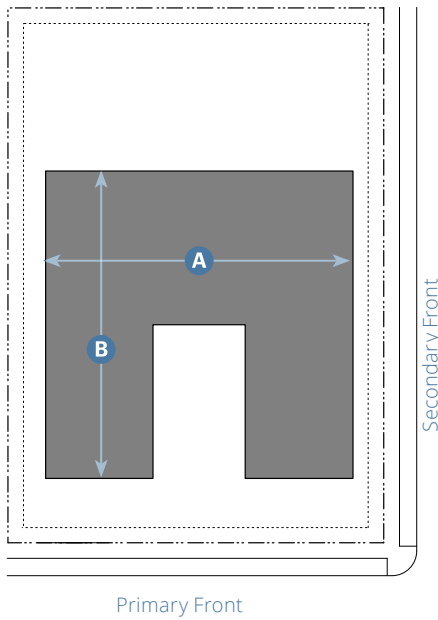

**Key**

- - - Lot/Design Site Line      ■ Building
- ..... Building Setback Line

**C. Building Size and Massing**

Height	NL	MUC; DE; DC
Stories	2.5 max. <sup>2</sup>	3 max.

<sup>2</sup> Up to 1/2 of each building footprint is allowed up to 3 stories, if located at least 35' behind the primary front façade.

**Main Body**

Width	_____ 100' max. _____	<b>A</b>
Depth	60' max.      80' max.	<b>B</b>
Separation between Buildings	_____ 10' min. _____	

**Wings**

Not Allowed

**Massing Types**

"L" Courtyard	Table 25.04.150.A.3
"U" Courtyard	Table 25.04.150.A.5

**Key**

- - - Lot/Design Site Line      ■ Frontage
- ..... Building Setback Line      ▨ Common Open Yard

**D. Pedestrian Access**

Main Entrance Location <sup>3</sup>	Courtyard or Primary Front	<b>C</b>
-------------------------------------	----------------------------	----------

<sup>3</sup> The main entry of ground floor units shall be directly off of a courtyard, primary front, or secondary front, whichever is closer.

**E. Vehicle Access and Parking**

Driveway and parking location shall comply with standards in Chapter 25.02 (Zones), Subsection E (Parking) of the Zone.	<b>D</b>
---	----------

Parking may be surface, garage/carport, tuck-under, or podium.

**F. Open Yard**

Open yard shall comply with standards in Section 25.03.040 (Open Yards).	<b>E</b>
--	----------

25.04.120 Large Multiplex



Local example in the West Downtown neighborhood



Local example in the Lower State neighborhood



Local example in the Laguna neighborhood

**A. Description**

A large-sized, detached, Block-Scale Building that consists of up to 18 attached or stacked units, typically with one shared entry. The type is scaled to fit within moderate-intensity neighborhoods.

**B. Number of Units/Buildings**

	MUC	DE
Units per Building	12 <sup>1</sup>	18 <sup>1</sup>
Main Buildings per Design Site	—————1 max.—————	

<sup>1</sup> Up to the maximum number of units allowed by General Plan density.



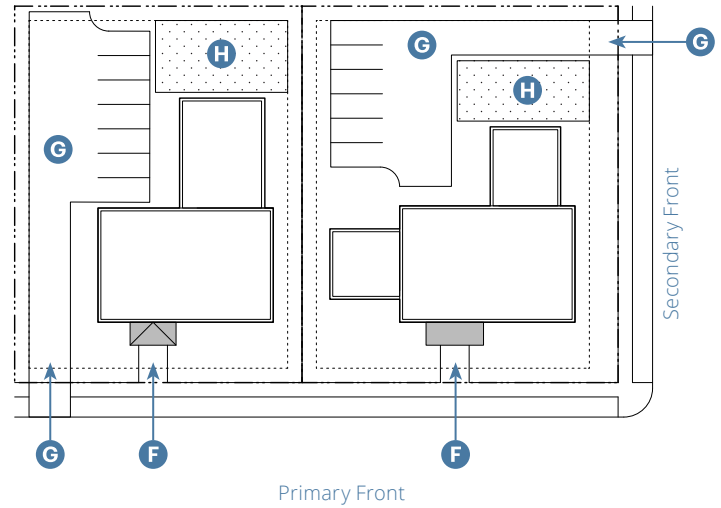
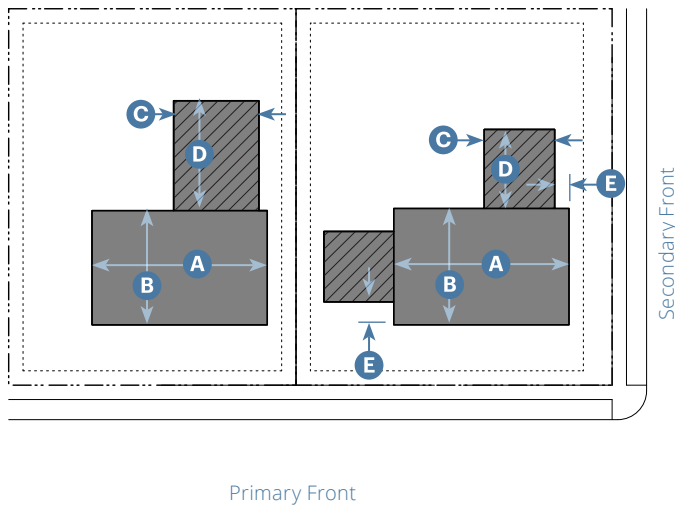

**Key**

- - - Lot/Design Site Line
- ..... Building Setback Line
- Building
- ▨ Wing

**C. Building Size and Massing**

Height	MUC	DE; DC
Stories	3.5 max.	4 max.
<b>Main Body</b>		
Width	60' max.	80' max. <b>A</b>
Depth	60' max.	100' max. <b>B</b>
<b>Wings</b>		
Width	24' max.	<b>C</b>
Depth	40' max.	<b>D</b>
Separation between Wings	10' min. up to 2 stories 15' min. for over 2 stories	
Offset from Main Body	5' min. if 2 or more stories; 0' min. if 1 story	<b>E</b>
Facade plane along primary front, secondary front, or community open space		

**Massing Types**

Wide Bar	Table 25.04.150.A.2
"L" Courtyard	Table 25.04.150.A.3
Wide "T"	Table 25.04.150.A.4
"U" Courtyard	Table 25.04.150.A.5

**Key**

- - - Lot/Design Site Line
- ..... Building Setback Line
- Frontage
- ▨ Common Open Yard

**D. Pedestrian Access**

Main Entrance Location Primary Front **F**

Units located in the main body shall be accessed by a common entry along the primary front.

On corner design sites, units in a wing may enter from the secondary front.

**E. Vehicle Access and Parking**

Driveway and parking location shall comply with standards in Chapter 25.02 (Zones), Subsection E (Parking) of the Zone. **G**

Parking may be surface, garage/carport, tuck-under, podium, or subterranean.

**F. Open Yard**

Open yard shall comply with standards in Section 25.03.040 (Open Yards). **H**

25.04.130 Large Courtyard



Local example in the West Downtown neighborhood



Local example in the Upper East neighborhood



Local example in the Laguna neighborhood

A. Description

A detached or attached, Block-Scale Building that consists of stacked units, accessed from one or more shared courtyards. The shared courtyard is common open yard. The type is typically integrated into moderate-to-high-intensity neighborhoods and on streets with a nonresidential ground floor.

B. Number of Units/Buildings

	MUC	DE	DC
Units per Design Site	24 <sup>1</sup>	50 <sup>1</sup>	50 <sup>1</sup>
Main Buildings per Design Site	2 max.		

<sup>1</sup> Up to the maximum number of units allowed by General Plan density.

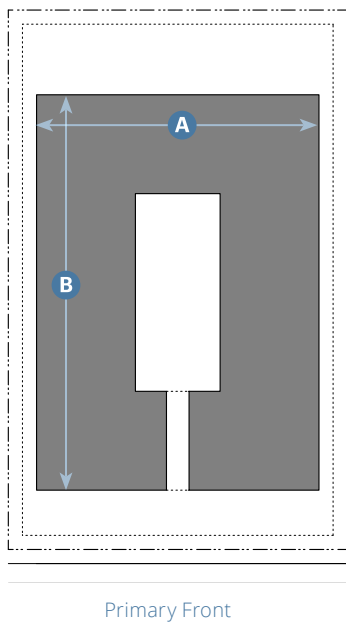

Primary Front

**Key**

- - - Lot/Design Site Line
- Building
- ..... Building Setback Line

**C. Building Size and Massing**

**Height**

Stories 4 max.

**Main Body <sup>2</sup>**

Width	200' max. <sup>3</sup>	<b>A</b>
Depth	200' max. <sup>3</sup>	<b>B</b>
Separation between Buildings	10' min.	

**Wings**

Not Allowed

**Massing Types**

"L" Courtyard	Table 25.04.150.A.3
"U" Courtyard	Table 25.04.150.A.5
"O" Courtyard	Table 25.04.150.A.6

<sup>2</sup> May be designed as two adjacent buildings, at least 15' but not more than 30' apart, in compliance with the standards of this Subsection.

<sup>3</sup> Façades along a primary or secondary front or along a community open space may be designed as multiple façades not exceeding 75 feet.

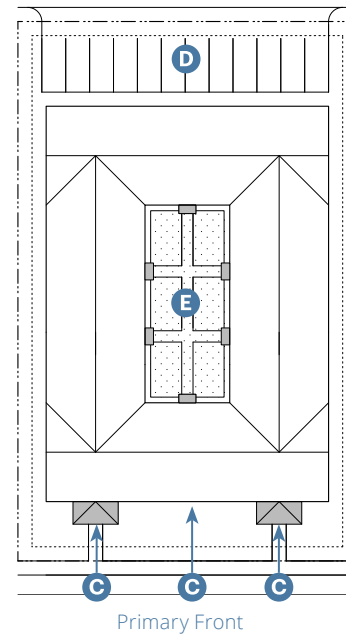

Primary Front

**Key**

- - - Lot/Design Site Line
- Frontage
- ..... Building Setback Line
- Common Open Yard

**D. Pedestrian Access**

Main Entrance Location<sup>4,5</sup> Courtyard or Primary Front **C**

Distance between Unit Entries 30' max.

<sup>4</sup> Ground floor units shall be entered directly off of a courtyard, primary front, or secondary front.

<sup>5</sup> The Courtyard shall be accessible and visible from the primary front via a Gateway (25.05.130) with an "O" Courtyard Massing Type.

**E. Vehicle Access and Parking**

Driveway and parking location shall comply with standards in Chapter 25.02 (Zones), Subsection E (Parking) of the Zone. **D**

Parking may be surface, garage/carport, tuck-under, podium, or subterranean.

**F. Open Yard**

Open yard shall comply with standards in Section 25.03.040 (Open Yards). **E**

25.04.140 Downtown Building



Local example in the Lower State neighborhood



Local example in the Downtown neighborhood



Local example in the Downtown neighborhood

**A. Description**

A Block-Scale Building, typically attached, but sometimes detached. The type is intended to provide a vertical mix of uses with ground-floor retail, office, or service uses and upper-floor residential uses. Ground floor residential can occur behind retail, office, or services uses on the primary front, and along secondary front.

**B. Number of Units/Buildings**

Units per Building	Unrestricted <sup>1</sup>
Main Buildings per Design Site	1 max.

<sup>1</sup>As allowed by General Plan maximum density.

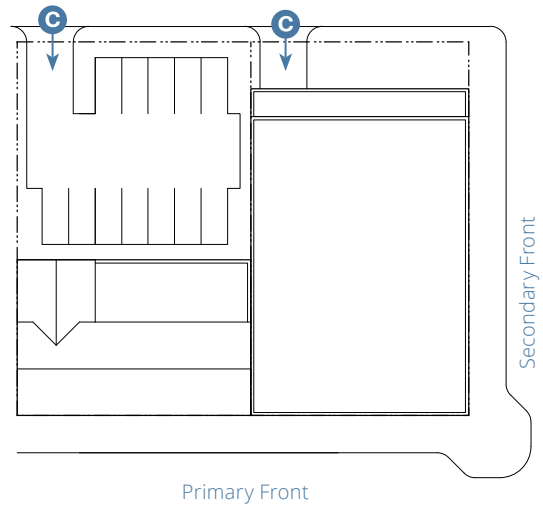
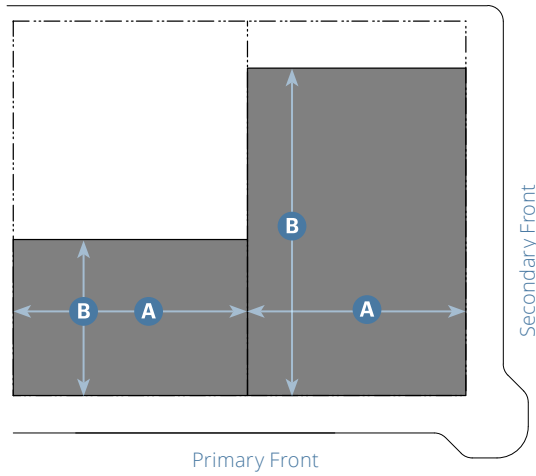

**Key**

- - - Lot/Design Site Line      ■ Building
- ..... Building Setback Line

**C. Building Size and Massing**

Height	
Stories	4 max.
Main Body	
Width	200 max. <b>(A)</b>
Depth	200 max. <b>(B)</b>
Wings	
Not Allowed	
Massing Types	
Narrow Box	Table 25.04.150.A.1
Wide Bar	Table 25.04.150.A.2
"L" Courtyard	Table 25.04.150.A.3
Wide "T"	Table 25.04.150.A.4
"U" Courtyard	Table 25.04.150.A.5
"O" Courtyard	Table 25.04.150.A.6

**Key**

- - - Lot/Design Site Line      ■ Frontage
- ..... Building Setback Line

**D. Pedestrian Access**

Main Entrance Location	Primary Front <sup>2</sup>
Distance between Entries	50' max.
along primary front, secondary front, open yard, community open space, or Paseo	

<sup>2</sup> Design sites on a corner may have unit entrances on the Secondary Front

**E. Vehicle Access and Parking**

Driveway and parking location shall comply with standards in Chapter 25.02 (Zones), Subsection E (Parking) of the Zone. **(C)**

Parking may be surface, garage/carport, tuck-under, podium, or subterranean.

**F. Open Yard**

Open yard shall comply with standards in Section 25.03.040 (Open Yards).

### 25.04.150 Massing Types

- A. **Main Body.** The main body massing type serves as an organizational framework for the building form in Table 25.04.150.A (Main Body Massing Types).
1. Allowed massing types for building types are listed in Chapter 25.04 (Building Types), Subsection C (Building Size and Massing) of the Building Type.
  2. Each massing type has a regulated main body width, projecting volumes, and recessed volumes. Façades of intersecting volumes shall be offset by a minimum of three feet.
  3. Each massing type may be rotated to any site orientation, provided the main body is consistent with Subsection C (Building Size and Massing) of the Building Type as measured consistent with Subsection 25.04.030.H (Measuring Building Types).
- B. **Architectural Massing Features.** A massing type does not preclude the incorporation of secondary architectural features such as bay windows, balconies, gables, dormers, tower elements, projections, recesses, stepbacks, or exterior stairs in compliance with Section 25.04.160 (Massing and Façade Composition) and the applicable zone standards.

Figure 25.04.150.1: Example of Massing Types

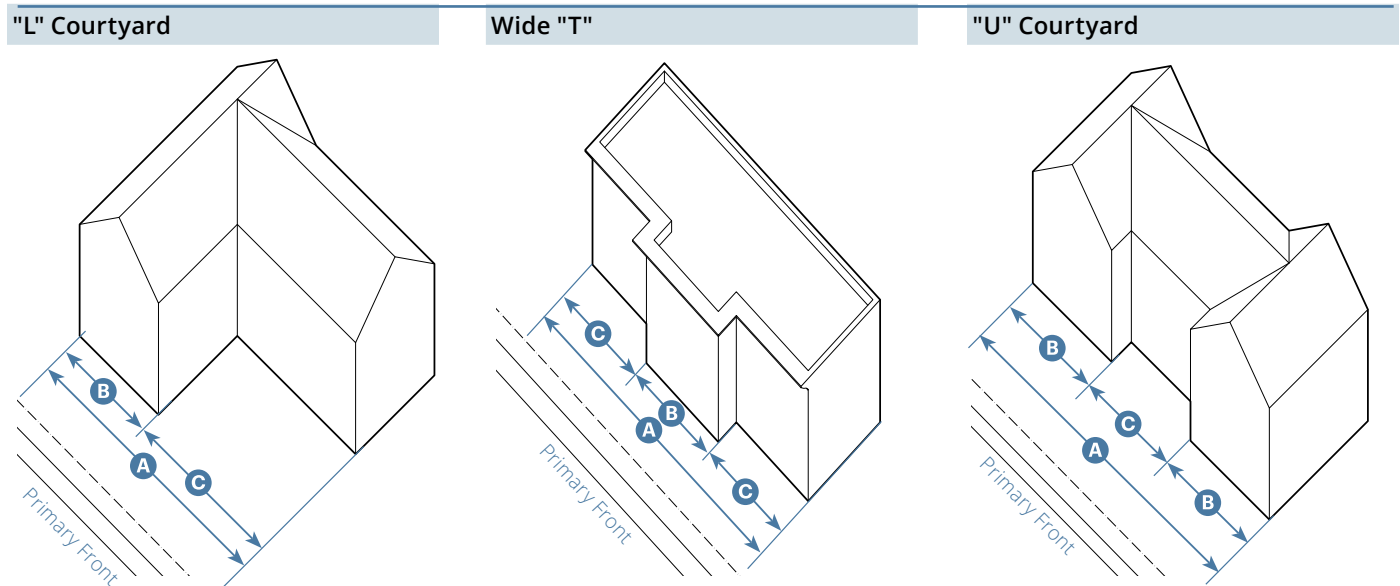

**Key**

<b>A Main Body Width</b>	Regulated by Subsection C (Building Size and Massing) of the Building Type.
<b>B Projecting Volume</b>	Regulated by the massing type.
<b>C Recessed Volume</b>	Regulated by the massing type.

Table 25.04.150.A: Main Body Massing Types

**1. Narrow Box**

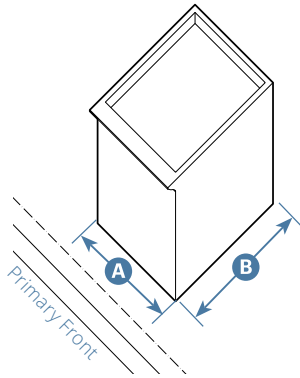

This massing type is a simple rectilinear form.

**Main Body**

Main Body Width	Max. allowed by Subsection C (Building Size and Massing) of the Building Type	<b>A</b>
Projecting Volume	No min.	
Recessed Volume	No min.	
Main Body Depth	Max. allowed by Subsection C (Building Size and Massing) of the Building Type	<b>B</b>

**2. Wide Bar**

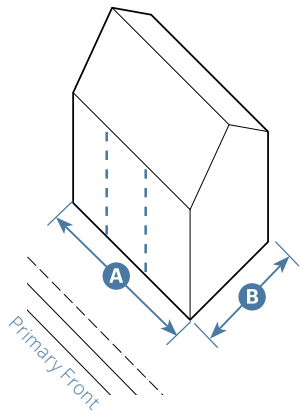

This massing type is a simple rectilinear form.

**Main Body**

Main Body Width	Max. allowed by Subsection C (Building Size and Massing) of the Building Type	<b>A</b>
Projecting Volume	No min.	
Recessed Volume	No min.	
Main Body Depth	Max. allowed by Subsection C (Building Size and Massing) of the Building Type	<b>B</b>

**3. "L" Courtyard**

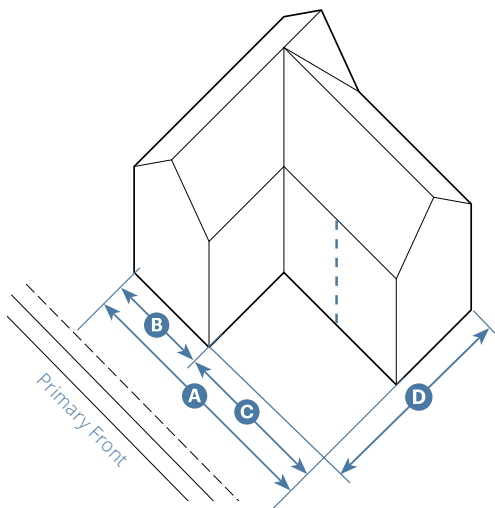

This massing type divides the façade into two parts, with one part projecting and one part recessed to create a courtyard.

**Main Body**

Main Body Width	Max. allowed by Subsection C (Building Size and Massing) of the Building Type	<b>A</b>
Projecting Volume	1 bay min.; 5 bays max. <sup>1</sup>	<b>B</b>
Recessed Volume	1 bay min.; 7 bays max. <sup>1</sup>	<b>C</b>
Main Body Depth	Max. allowed by Subsection C (Building Size and Massing) of the Building Type	<b>D</b>

<sup>1</sup>No max. for Block-Scale Buildings.

Table 25.04.150.A: Main Body Massing Types

**4. Wide "T"**

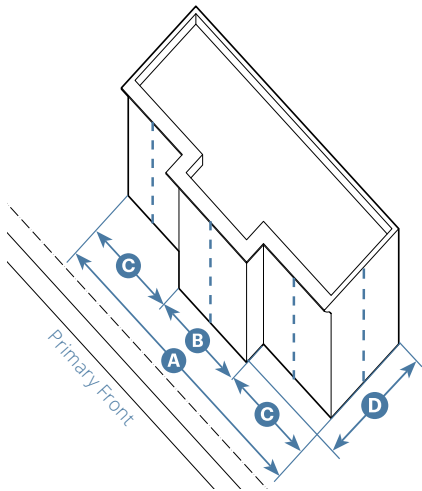

This massing type divides the façade into three parts, with the middle part projecting.

Main Body		
Main Body Width	Max. allowed by Subsection C (Building Size and Massing) of the Building Type	<b>A</b>
Projecting Volume	1 bay min.; 5 bays max. <sup>1</sup>	<b>B</b>
Recessed Volume	1 bay min.; 7 bays max. <sup>1</sup>	<b>C</b>
Main Body Depth	Max. allowed by Subsection C (Building Size and Massing) of the Building Type	<b>D</b>

**5. "U" Courtyard**

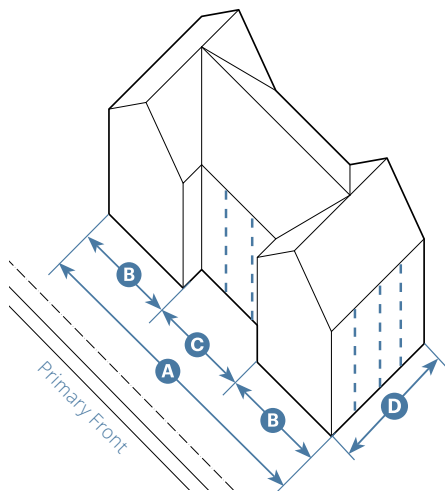

This massing type divides the façade into three parts, with the middle part recessed slightly to create a forecourt.

Main Body		
Main Body Width	Max. allowed by Subsection C (Building Size and Massing) of the Building Type	<b>A</b>
Projecting Volume	1 bay min.; 5 bays max. <sup>1</sup>	<b>B</b>
Recessed Volume	1 bay min.; 9 bays max. <sup>1</sup>	<b>C</b>
Main Body Depth	Max. allowed by Subsection C (Building Size and Massing) of the Building Type	<b>D</b>

**6. "O" Courtyard**

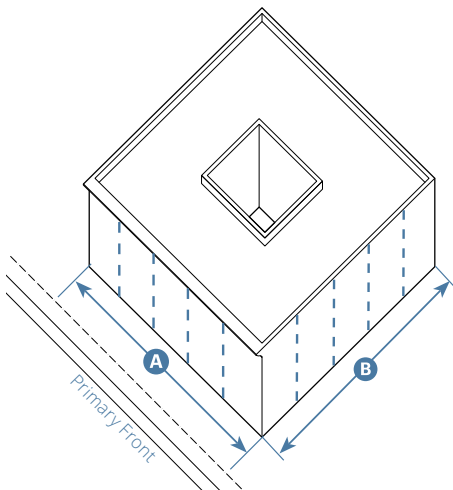

This massing type fronts a courtyard with building façades on all four sides. The courtyard is separated from the right-of-way by the mass of the building.

Main Body		
Main Body Width	Max. allowed by Subsection C (Building Size and Massing) of the Building Type	<b>A</b>
Projecting Volume	No min.	
Recessed Volume	No min.	
Main Body Depth	Max. allowed by Subsection C (Building Size and Massing) of the Building Type	<b>B</b>

<sup>1</sup> No max. for Block-Scale Buildings.



## 25.04.160 Massing and Façade Composition

- A. **Intent.** Santa Barbara's architecture reflects traditional design principles that contribute to a pleasant, human-scale environment. These include a clear representation of each building's relationship to the ground and sky, as well as how openings such as doors and windows establish an interface between the inside, the outside, and the building structure itself. Table 25.04.160.A (Massing and Façade Composition Overview) provides an overview of massing and façade composition standards that support these principles.

**Table 25.04.160.A: Massing and Façade Composition Overview**

**Massing, Façade Composition and Architectural Elements Standards**

Standard	Applicable Buildings
25.04.160.B (Tripartite Design)	Buildings of at least 2 stories.
25.04.160.C (Bay Composition)	Buildings of at least 2 stories.
25.04.160.D (Parapet Roof Distribution)	Buildings of at least 2 stories.
25.04.160.E (Architectural Massing Features)	Block-scale buildings of at least 2 stories and over 80' in length <sup>1</sup> , measured along an adjacent right-of-way.

<sup>1</sup> Include main body and wings.

- B. **Tripartite Design.** Buildings of at least two stories have a base, middle, and top as required by Chapter 25.06 (Architectural Design), Subsection C (Wall) of the Architectural Style. See Figure 25.04.160.1 (Example of Base, Middle, and Top Divisions).
1. Base. See Chapter 25.06 (Architectural Design), Subsection C (Wall) for base standards and required articulation between base and middle, if applicable. If no base is required by the selected style or included as an optional element, base is considered to coincide with the building's foundation unless otherwise indicated by the applicant.
  2. Middle. See Chapter 25.06 (Architectural Design), Subsection C (Wall) for middle standards.
  3. Top. See Chapter 25.06 (Architectural Design), Subsection D (Roof), for top standards. Top includes all elements regulated by Chapter 25.06 (Architectural Design), Subsection E (Rake), Subsection F (Eave), Subsection G (Parapet), and Subsection J (Dormers).

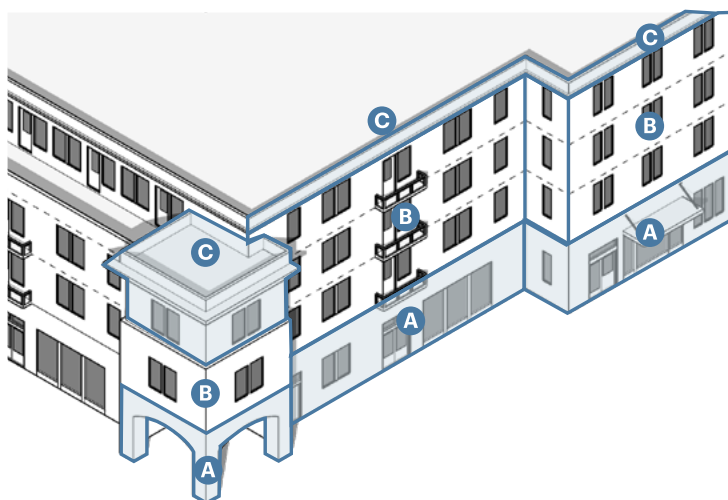

**Figure 25.04.160.1: Example of Base, Middle, and Top Divisions**

- C** Top
- B** Middle
- A** Base

- C. **Bay Composition.** The pattern of openings in the wall of a building is one of its most easily recognizable features, instantly providing a sense of scale, defining the relationship between the interior and the exterior, and providing both order and visual interest along a building face.
1. Each façade shall be arranged according to a pattern of vertical bays. See Figure 25.04.160.3 (Examples of Bay Compositions within a Massing Type) for examples that are consistent with the intent of this standard.
  2. For each volume/façade of main body massing, identify and apply a number of bays within the allowed range.
  3. Standards.
    - (a) Each bay shall be at least 4 feet wide and no wider than 17 feet; except that in the Downtown Edge (DE) and Downtown Core (DC) zones, bays within the building's base may be up to 25 feet wide.
    - (b) Bays are not required to be equal in width.
    - (c) Within each façade plane, the base, middle, or top may use a different horizontal rhythm of bays. Within the base, middle, or top, the horizontal rhythm of bays must be consistent. See Figure 25.04.160.2 (Example of Bay Composition).
    - (d) Walls without fenestration, material changes, or details shall not exceed 10 feet in length, measured horizontally from the edge of each opening to the nearest opening or façade edge.
  4. Measurement.
    - (a) Bay width shall be measured horizontally from one boundary to the opposite boundary.
    - (b) Bay boundary is the midpoint between successive openings unless marked by a projecting or recessed volume on the façade.
    - (c) Boundaries of each bay shall extend vertically from the lower boundary of the base, middle, or top to the upper boundary of the same division and shall not intersect any opening.
    - (d) Where applicable, bay boundary shall coincide with the boundary of any massing feature type identified in accordance with Subsection 25.04.160.E (Architectural Massing Features).

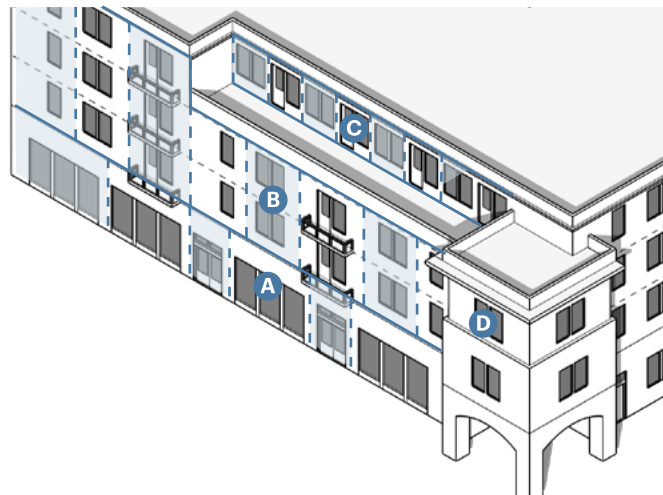

**Figure 25.04.160.2:**  
**Example of Bay Composition**

- A** Bay Composition: Base
- B** Bay Composition: Middle
- C** Stepped-back façade plane may have different bay composition from foremost façade plane
- D** Tower element is treated independently

Figure 25.04.160.3: Examples of Bay Compositions within a Massing Type

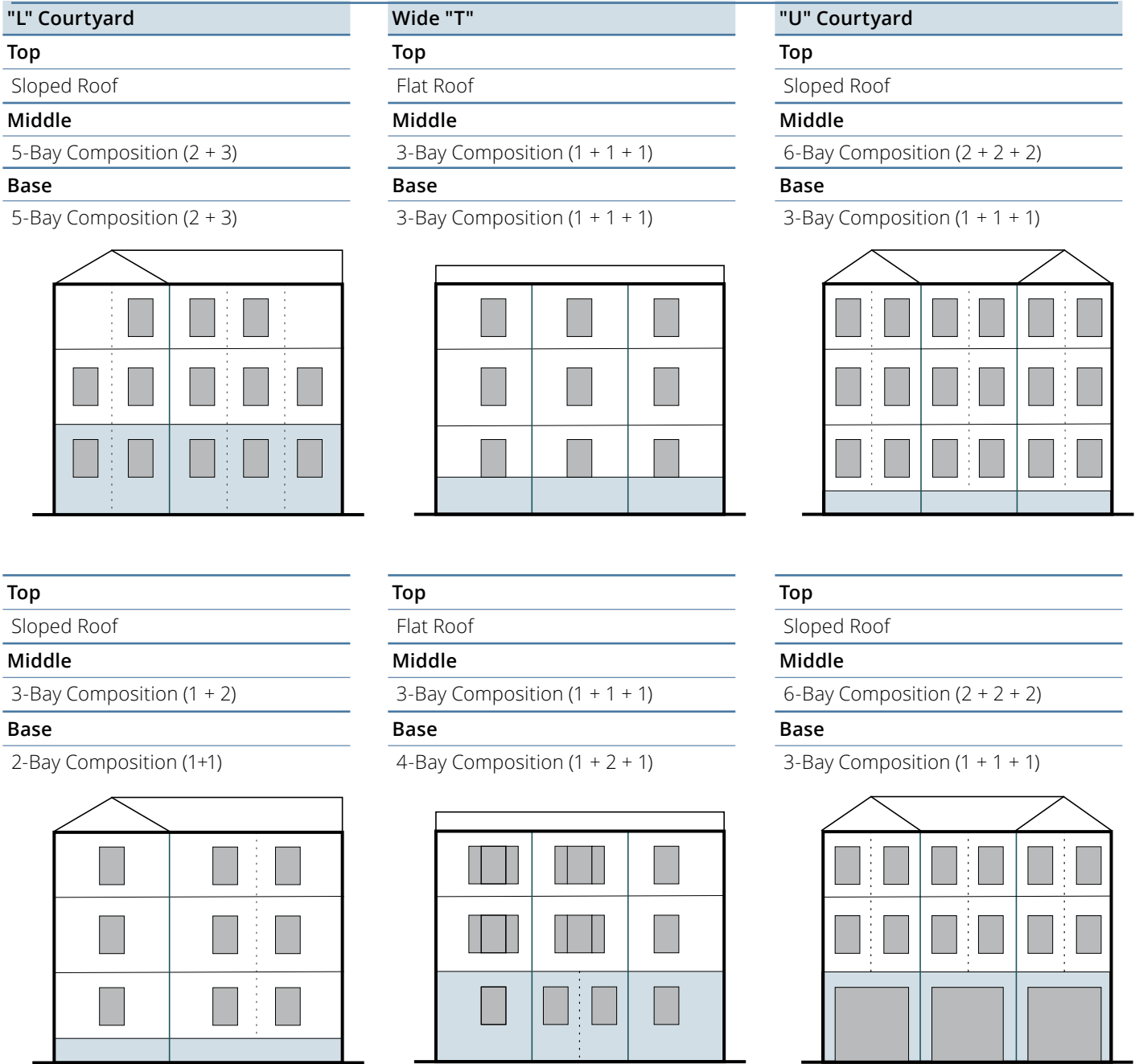

Key

 Building Base

See Subsection 25.04.160.B (Tripartite Design).

D. **Parapet Roof Distribution.** Application of parapets to roofs is regulated according to Chapter 25.06 (Architectural Design), Subsection D (Building Roof) of the Architectural Style.

1. Roof Form Terminations. See Figure 25.04.160.4 (Example of Parapet Roofs).
  - (a) Where sloped roof parapet adjoins a side wall or shared lot line, sloped profile shall terminate at lot line or side wall and shall not wrap the corner. Flat roof parapet may extend to the rear along lot line or side wall.
  - (b) A flat roof parapet adjacent to a sloped roof parapet shall extend or return to establish continuity between the two.

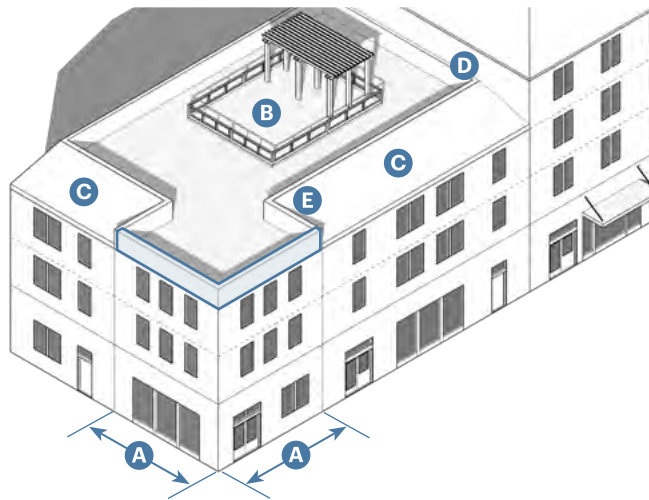

**Figure 25.04.160.4:**  
**Example of Parapet Roofs**

- |          |   |
|----------|---|
| <b>A</b> | Allowed length of flat roof parapet along each primary or secondary front elevation |
| <b>B</b> | Rooftop deck (Section 25.03.140)  |
| <b>C</b> | Sloped roof parapet   |
| <b>D</b> | Roof Form Termination: Sloped roof parapet adjoining side wall                      |
| <b>E</b> | Roof Form Termination: Flat roof parapet returning to link with sloped roof parapet |

- E. **Architectural Massing Features.** Block-Scale Buildings shall include massing features to add interest and improve the legibility of the streetscape.
1. Block-Scale Buildings of at least two stories in height and greater than 80 feet in length shall meet the standards in this Subsection for each primary front and secondary front elevation. For house-scale buildings, refer to the standards in Section 25.04.150 (Massing Types).
  2. For the purpose of satisfying the required number of massing features, separate instances may be counted toward the required minimum number.

Table 25.04.160.B: Required Architecture Massing Features by Elevation Length	
Elevation Length	Quantity of Massing Features Required <sup>1</sup>
Up to 80'	None required
Greater than 80', up to 120'	1 min.
Greater than 120', up to 160'	2 min.
Over 160'	3 min.

<sup>1</sup>A single elevation may include more than one instance of an architectural massing feature type.

Figure 25.04.160.5: Example of Massing Features by Elevation Length



3. Projecting Volume. A projecting volume extends outward from the building to create a visual focal point on the buildings façade.
  - (a) Projecting Volumes must project three feet min. from the adjacent façade.
  - (b) Projecting Volumes must be a minimum of 10 feet wide and no longer than 40 feet.
  - (c) Projecting Volumes shall extend vertically throughout the building's middle and may also extend through the top and/or base.
  - (d) The roof form of a Projecting Volume shall correspond to that of the volume from which it projects and shall maintain the same eave height. Gable or hip roofs shall include a ridge running perpendicular to the projecting façade.
4. Recessed Volume. A recessed volume adds visual interest and creates depth and variation to the buildings façade.
  - (a) Recessed Volumes must recess three feet min. from the adjacent façade.
  - (b) Recessed Volumes must be a minimum of eight feet wide and no longer than 40 feet.
  - (c) Recessed Volumes shall extend vertically throughout the building's middle and top and may also extend through the base.
  - (d) Gable or hip roofs shall break at Recessed Volumes by maintaining the same eave height on all sides of the recessed volume where eaves occur.
  - (e) When extending to the ground plane, Recessed Volumes shall incorporate landscape, outdoor seating, and/or an extension of the sidewalk pavement.
  - (f) Recessed Volume may coincide with a frontage type such as the dooryard or forecourt. See Chapter 25.05 (Frontages).
  - (g) Where a Recessed Volume is identified, adjacent façades from which the recess is measured may not be counted as a Projecting Volume.
5. Tower Element. A tower element adds interest to the roofline and further shapes the public realm.
  - (a) Tower Elements must project or recess a minimum of three feet from adjacent façades.
  - (b) Tower Elements must have a minimum footprint of 10 feet by 10 feet and maximum footprint of 30 feet by 30 feet.
  - (c) When the highest story of the building is at the maximum height allowed by the zone, Tower Element may exceed maximum height allowed by the zone by up to 10 feet unless further limited in height in compliance with Section 25.02.030 (General Requirements).
    - (1) A Tower Element exceeding maximum height allowed by the zone shall not add occupiable floor area to the structure, in compliance with *Subsection 30.140.100.A (Exceptions to Height Limitations)*.
  - (d) Where a Tower Element is identified, adjacent façades may not be counted as a Projecting Volume or Recessed Volume.

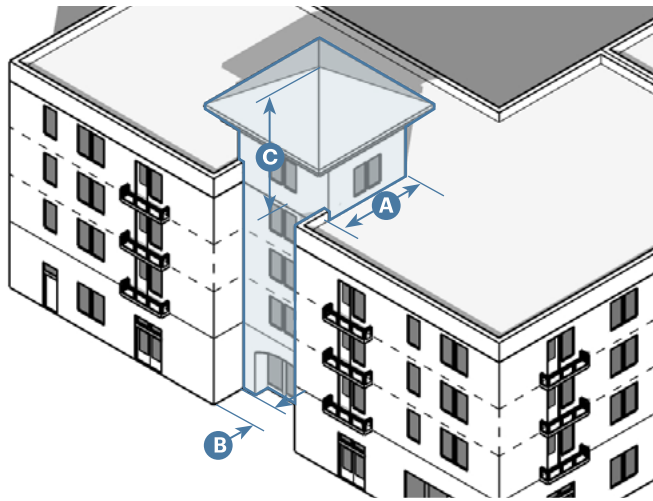

**Figure 25.04.160.6:**  
**Example of Tower Element**

- A** Tower element footprint
- B** Projection or recess
- C** Height allowance

6. Additional Massing Stepback. An additional massing stepback creates depth and variation to the upper stories of a building.
  - (a) Additional Massing Stepbacks must stepback a minimum of 10 feet from the primary façade.
  - (b) Additional Massing Stepbacks must be a minimum of 30 feet wide and no longer than 80 feet.
  - (c) Additional Massing Stepbacks shall modify the building's uppermost story and may also modify the second-highest story.
  - (d) The elevated area created by the Additional Massing Stepback shall be roofed in compliance with Chapter 25.06 (Architectural Design), Subsection D (Building Roof) of the Architectural Style.
  - (e) The Additional Massing Stepback may overlap with the front stepback required by the zone, provided the required front stepback portion does not include a deck. In zones where there is no required front setback, the Additional Massing Stepback may include a deck and can be used for open yard in compliance with Section 25.03.040 (Open Yards).
  - (f) A corner element that is at least five feet lower in height than the surrounding building volume in compliance with Subsection 25.04.170.C (Specific to Corner Parcels) may be counted as an Additional Massing Stepback in fulfillment of this Subsection.

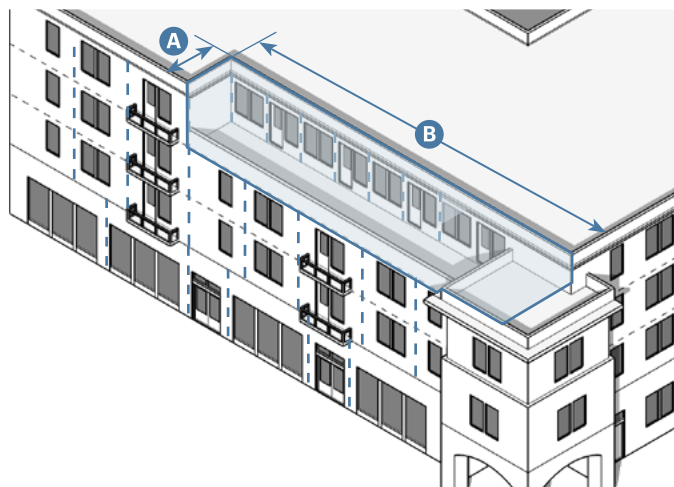
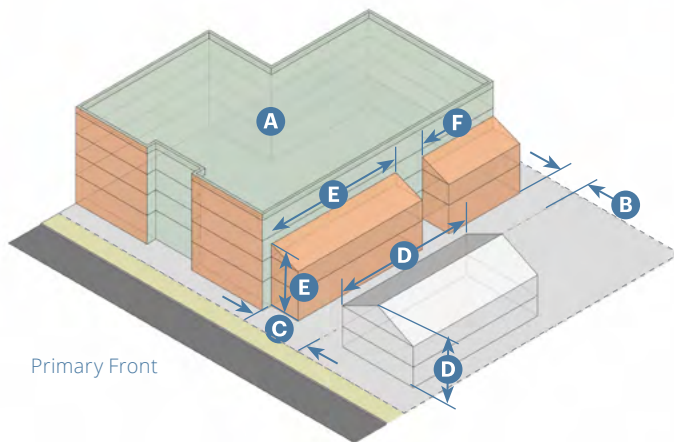

**Figure 25.04.160.7:**  
**Example of Upper-Story Stepback**

- A** Stepback from Primary Façade
- B** Length of Stepback

**25.04.170 Adjacency and Height Standards**

- A. **Intent.** This Section establishes adjacency standards to ease transitions from newer buildings to existing buildings in relation to the site and surrounding neighborhood and height standards to protect public views at corner parcels.
- B. **Block-Scale Buildings Adjacent to House-Scale Buildings.** A 20-foot minimum Transition Area is required along the length of the shared interior property line where a new Block-Scale Building is proposed adjacent to an existing House-Scale Building that is 30 feet or less in height and 80 feet or less in length. See Figure 25.04.170.1 (Transition to House-Scale Building Size).
  - 1. Within 20 feet of the shared interior property line:
    - (a) The new Block-Scale Building height shall not exceed 30 feet; and
    - (b) The new Block-Scale Building volume shall be no longer than the longest existing House-Scale Building dimension. Multiple volumes of this or smaller size are allowed within the 20-foot Transition Area provided they are separated with a minimum 15 foot distance between each volume.



**Figure 25.04.170.1:**  
**Transition to House-Scale Building Size**

- A** New Building (Max. height allowed by zone— e.g., 4 stories)
- B** Required Min. Interior Setback
- C** Required Transition Area: 20' min.
- D** Existing Building: Height and longest dimension along adjacent interior property line
- E** New building massing not to exceed existing building's height and length
- F** 15' min. Separation Between Volumes

- C. **Specific to Corner Parcels.** Buildings shall not exceed 30 feet in height within a minimum 25 feet of a corner measured along both of the intersecting streets extending to a 25-foot min. depth from each right-of-way. Parcels with a street frontage of less than 60 feet along the primary front are exempt from this height limit. See Figure 25.04.170.2 (Height Limit at Corners).

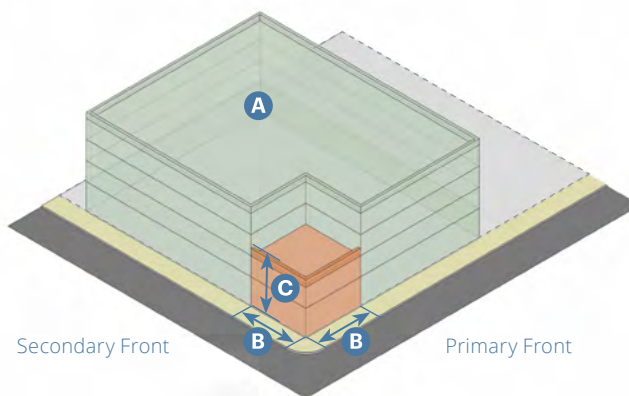
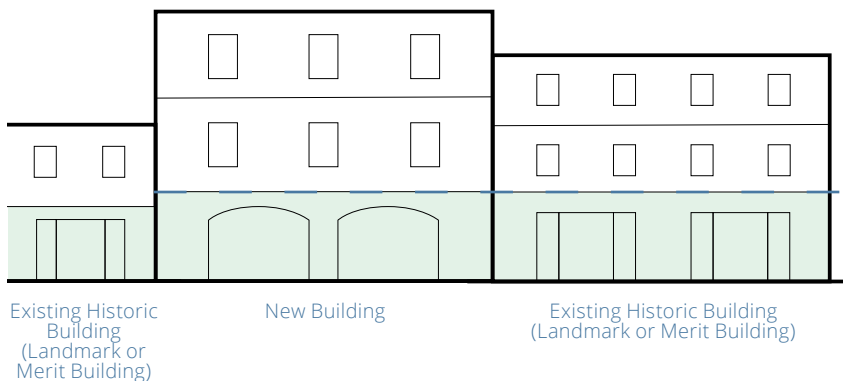

**Figure 25.04.170.2:**  
**Height Limit at Corners**

- A** New Building (Max. height allowed by zone— e.g., 4 stories)
- B** 25' min. x 25' min. Area at Corner
- C** Height Limit: 30' max.



- D. **New Building Adjacent to Historic Resource.** The following historic sensitivity standards are required when at least one historic resource building is located within 20 feet of the shared interior lot line of a new building:
1. **Front Setback.** The front setback of the new building shall be the minimum front setback of the zone or equal to the smallest front setback of the historic resource, whichever is greater. At no point shall the front setback exceed 20 feet, regardless of the setback of the historic resource.
  2. **Expression Line.** The façade of the new building along the primary or secondary front shall have a ground floor expression line or entablature at the same height as the ground floor expression line or entablature on the existing adjacent historic resource building. The top of the expression line or entablature shall be used for the purpose of determining this height. Where two existing historic resource buildings abut the site, the resource with the taller expression line applies. See Figure 25.04.170.3 (Required Ground Floor Expression Line Alignment).
  3. **Transition Area.** Within a Transition Area measured 20 feet inward from the front façade of the existing historic resource and 20 feet inward from the shared interior lot line, the new building volume shall not exceed the height, width, and length of the adjacent existing historic resource or 30 feet, whichever is greater, in compliance with the zone standards. Multiple volumes of this or smaller size are allowed within the Transition Area provided they are separated with a minimum 15 foot distance between each volume. See Figure 25.04.170.4 (Transition to Historic Resource Building Size).



**Figure 25.04.170.3:**  
Required Ground Floor Expression Line Alignment

- - Ground Floor Expression Line
- Ground Floor

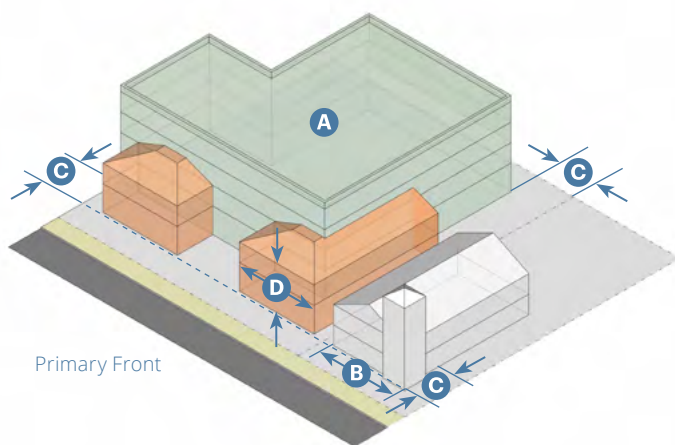

**Figure 25.04.170.4:**  
Transition to Historic Resource Building Size

- A** New Building (Max. height allowed by zone—e.g., 4 stories)
- B** Existing 1- to 2-story Historic Resource Footprint along primary front
- C** Required Transition Area: 20'
- D** New building massing not to exceed existing Historic Resource width, length, and height, or 30 feet, whichever is greater

*This page intentionally left blank*

# Chapter 25.05 Frontages

---

## Sections:

25.05.010	Purpose
25.05.020	General Requirements
25.05.030	Allowed Frontage Types
25.05.040	Porch Projecting
25.05.050	Porch Recessed
25.05.060	Dooryard
25.05.070	Stoop
25.05.080	Forecourt
25.05.090	Maker Shopfront
25.05.100	Shopfront
25.05.110	Terrace
25.05.120	Gateway
25.05.130	Arcade

---

## 25.05.010 Purpose

This Chapter provides the standards for frontages to create pedestrian-oriented environments that are attractive, functional, safe, and accessible to all people. Frontages are the components of a building that provide the transition and interface between the public realm (street and sidewalk) and the private realm (setback or building at/near the sidewalk).

---

## 25.05.020 General Requirements

- A. **Names.** The names of the frontage types indicate their particular configuration or function and are not intended to limit uses within the associated building. For example, a Porch may be used by nonresidential uses including, but not limited to, a restaurant or office, as allowed by the zone.
- B. **Location.**
  - 1. Each building is required to include at least one frontage type to provide access to the ground floor occupiable/usable space along the primary front. Buildings with entries along a secondary front or community open space are required to include at least one frontage type on those façades.
  - 2. Each frontage type shall be located in compliance with the façade zone per Chapter 25.02 (Zones), Subsection D (Building Placement) of the Zone.
  - 3. Frontages can encroach into the primary and secondary front setbacks by a maximum of 10 feet in the Neighborhood Medium (NM), Neighborhood Large (NL), and Mixed-Use Corridor (MUC) zones and Chapter 25.05 (Frontages), Subsection B (Required Elements) of the Frontage. See *Section 30.140.090 (Encroachments into Setbacks and Open Yards)* for other allowed encroachments.

- C. **Multiple and Combined Frontages.** Buildings may include more than one frontage type in compliance with the allowed types in Chapter 25.02 (Zones), Subsection F (Frontages) of the Zone and may assemble more than one frontage type together, such as a forecourt with a shopfront, in compliance with Table 25.05.030.B (Allowed Combinations of Frontage Types).
- D. **Coverings.** An awning or recessed entry may be required or allowed in compliance with the frontage type and standards in Chapter 25.06 (Architectural Design) for the Architectural Style and shall provide a minimum eight foot vertical clearance above the side walk and a minimum two foot setback from curb.
- E. **Design.** Frontage types shall be designed in compliance with the standards in Chapter 25.06 (Architectural Design) for the Architectural Style.
- F. **Ramps.** Ramps connecting a frontage type and right-of-way shall be designed in compliance with the following:
  - 1. Located along the side of the building; or
  - 2. Parallel to the front façade and not exceed 18 inches in rise; ramp shall include a wall up to 36 inches tall that includes a landscape planter at least two feet wide or a bench. The wall shall be designed using any of the wall materials on the main building.

### 25.05.030 Allowed Frontage Types

A. Table 25.05.030.A (Allowed Frontage Types) provides a summary of frontage types allowed in each zone.

Table 25.05.030.A: Allowed Frontage Types						
Frontage	Specific Standards	Zones				
		NM	NL	MUC	DE	DC
<b>House-Scale</b>						
Porch Projecting	25.05.040	A	A	A <sup>1</sup>	A <sup>1</sup>	A <sup>1</sup>
Porch Recessed	25.05.050	A	A	A <sup>1</sup>	A <sup>1</sup>	A <sup>1</sup>
Dooryard	25.05.060	A	A	A	A <sup>2</sup>	A <sup>2</sup>
Stoop	25.05.070	A	A	A	A	A
<b>Block-Scale</b>						
Forecourt	25.05.080	—	—	A	A	A <sup>3</sup>
Maker Shopfront	25.05.090	—	—	A <sup>3</sup>	A <sup>3</sup>	A <sup>3</sup>
Shopfront	25.05.100	—	A <sup>3</sup>	A <sup>3</sup>	A <sup>3</sup>	A <sup>3</sup>
Terrace	25.05.110	—	A	A	A <sup>3</sup>	A <sup>3</sup>
Gateway	25.05.120	—	—	—	A	A
Arcade	25.05.130	—	—	—	A	A
<b>Key</b>		A = Allowed			— = Not Allowed	

<sup>1</sup> Frontage only allowed on House-Scale Buildings.

<sup>2</sup> Only on secondary front and at least 60 feet back from the primary front design site line.

<sup>3</sup> Only for ground floor nonresidential frontages.

B. Table 25.05.030.B (Allowed Combinations of Frontage Types) provides a summary of which frontage types can be combined, consistent with the frontages allowed by zone.

Table 25.05.030.B: Allowed Combinations of Frontage Types										
Frontage	Porch Projecting	Porch Recessed	Dooryard	Stoop	Forecourt	Maker Shopfront	Shopfront	Terrace	Gateway	Arcade
Porch Projecting	—	—	—	—	—	—	—	—	—	—
Porch Recessed	—	—	—	—	—	—	—	A	—	—
Dooryard	—	—	—	A	—	A	A	—	—	—
Stoop	—	—	A	—	A	—	—	—	—	—
Forecourt	—	—	—	A	—	A	A	A	—	A
Maker Shopfront	—	—	A	—	A	—	—	A	—	—
Shopfront	—	—	A	—	A	—	—	A	A	A
Terrace	—	A	—	—	A	A	A	—	—	—
Gateway	—	—	—	—	—	—	A	—	—	—
Arcade	—	—	—	—	A	—	A	—	—	—
<b>Key</b>		A = Allowed					— = Not Allowed			

25.05.040 Porch Projecting



Local example in the West Downtown neighborhood



Local example in the Upper State neighborhood



Local example in the Oak Park neighborhood

A. Description

A Projecting Porch is a covered structure extending from the front façade of the building and may encroach into the front setback. It is one story and open on three sides.

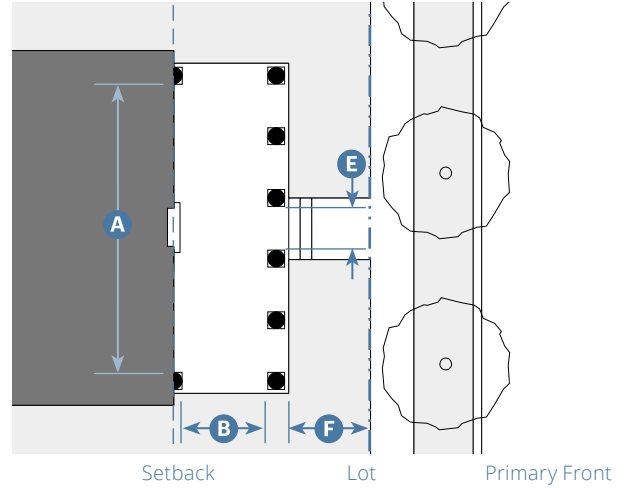
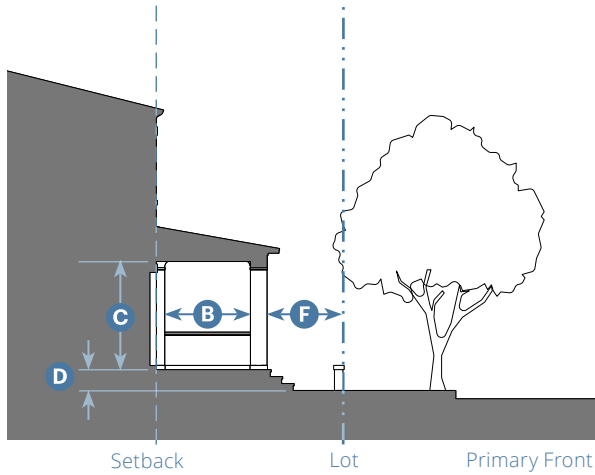

**Key**

--- Lot/Design Site Line      - - - - - Setback Line

**B. Required Elements**

Width, Clear	15' min. <sup>1</sup> ; 100% façade length, max.	<b>A</b>
Depth, Clear	6' min.; 10' max.	<b>B</b>
Height, Clear	8' min.	<b>C</b>
Stories	1 story max.	
Finish Level above Sidewalk	12" min. <sup>2</sup> ; 4' max.	<b>D</b>
Pedestrian Access	3' wide min.	<b>E</b>
Distance between Porch Elements and ROW/Design Site Line	5' min. <sup>3</sup>	<b>F</b>

<sup>1</sup>Reduce to 6' min. when applied to Cottage Court Building Type (Section 25.04.070).

<sup>2</sup>Common entries may be set at grade per local and federal accessibility standards.

<sup>3</sup>Outside porch steps may be located 2' min. from ROW.

**C. Additional Requirements**

Porch shall be open on three sides and have a roof.  
Pedestrian access allowed at the front or end side of Porch.

25.05.050 Porch Recessed



Local example in the West Downtown neighborhood



Local example in the Oak Park neighborhood



Local example in the Laguna neighborhood

**A. Description**

A Recessed Porch is a covered structure embedded within the front façade. It is one or two stories and has one or two open sides.

The Recessed Porch may be combined with a Terrace (25.05.110).



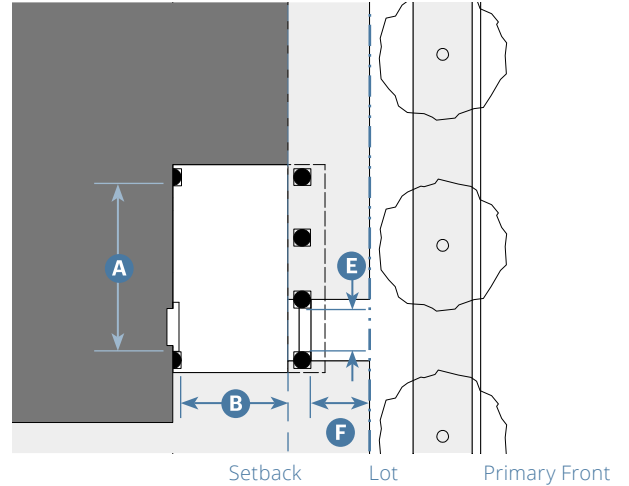
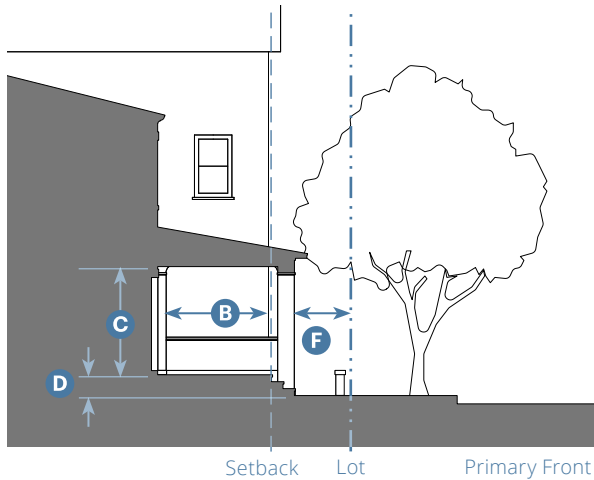

**Key**

--- Lot/Design Site Line      - - - - - Setback Line

B. Required Elements		
Width, Clear	8' min. <sup>1</sup> ; 50% façade length, max.	<b>A</b>
Depth, Clear	6' min.; 10' max.	<b>B</b>
Height, Clear	8' min.	<b>C</b>
Stories	2 stories max.	
Finish Level above Sidewalk	12" min. <sup>2</sup> ; 4' max.	<b>D</b>
Pedestrian Access	3' wide min.	<b>E</b>
Distance between Porch Elements and ROW/Design Site Line	5' min. <sup>3</sup>	<b>F</b>

<sup>1</sup>Reduce to 6' min. when applied to Cottage Court Building Type (Section 25.04.070).

<sup>2</sup>Common entries may be set at grade per local and federal accessibility standards.

<sup>3</sup>Outside porch steps may be located 2' min. from ROW.

**C. Additional Requirements**

Porch shall be engaged with the building on a minimum of two sides, open on at least one side, and have a roof.  
Pedestrian access allowed at the front or end side of Porch.

25.05.060 Dooryard



Local example in the Eastside neighborhood



Local example in the Lower West neighborhood



Local example in the East Beach neighborhood

**A. Description**

A Dooryard is a small private area between the right-of-way and the front façade. It is separated from the right-of-way and adjacent dooryards by a low wall or hedge and may be raised or at grade.

The Dooryard may be combined with a Stoop (25.05.070), Maker Shopfront (25.05.090), or Shopfront (25.05.100).

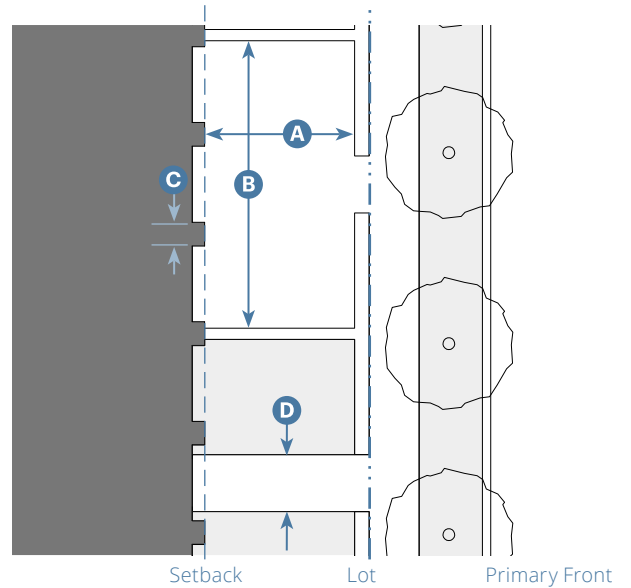
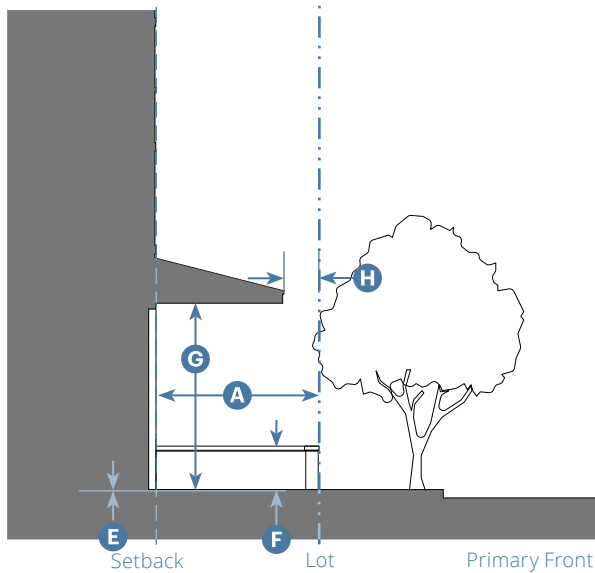

**Key**

--- Lot/Design Site Line      - - - - - Setback Line

**B. Required Elements**

Depth, Clear	Minimum front setback <b>A</b> per zone, or 5' min., whichever is greater; 10' max.
Length, Clear	15' min.; 100% façade <b>B</b> length max.
Distance between Glazing	4' max. <b>C</b>
Pedestrian Access	3' wide min. <b>D</b>
Finish Level above Sidewalk	12" max. <sup>1</sup> <b>E</b>
Height of Dooryard Fence/Wall	42" max. <b>F</b>
Vertical Clear Height	8' min. <b>G</b>
Distance Between Covered Entry and ROW/Design Site Line	2' min. <b>H</b>

<sup>1</sup> Common entries may be set at grade per local and federal accessibility standards.

**C. Additional Requirements**

Each Dooryard shall provide access to only one ground floor entry.  
Dooryard shall include a covered entry.

25.05.070 Stoop



*Local example in the West Beach neighborhood*



*Local example in the Lower Riviera neighborhood*



*Local example in the Eastside neighborhood*

**A. Description**

A Stoop is a small, covered entrance with a stair or ramp from the right-of-way to the unit entrance. It may be recessed or projecting.

The Stoop may be combined with a Dooryard (25.05.060) or Forecourt (25.05.080).

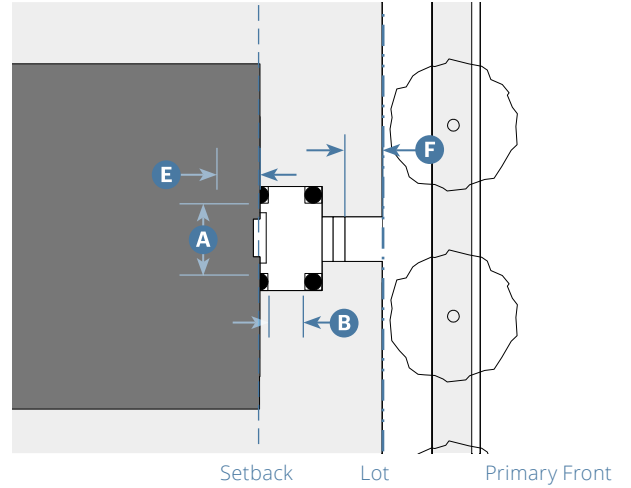
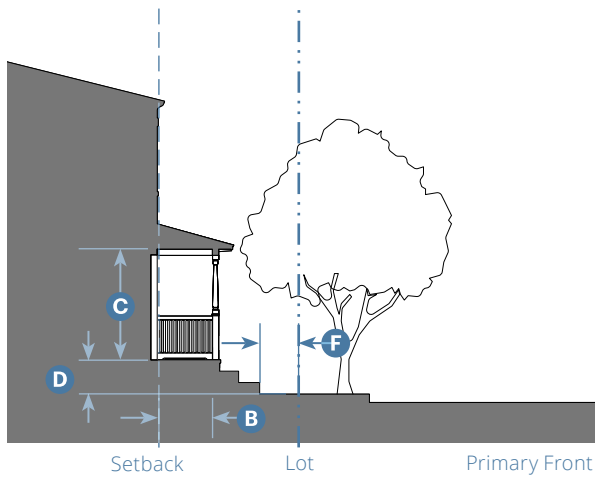

**Key**

--- Lot/Design Site Line      ..... Setback Line

**B. Required Elements**

Width, Clear	4' min.; 10' max.	<b>A</b>
Projecting Stoop Depth, Clear	3' min.; 8' max.	<b>B</b>
Height, Clear	8' min.	<b>C</b>
Finish Level above Sidewalk	4' max.	<b>D</b>
Recessed Stoop, Depth	5' max.	<b>E</b>
Distance Between Stoop Stair and ROW/Design Site Line	3' min.	<b>F</b>

**C. Additional Requirements**

- Stairs are perpendicular or parallel to the building façade.
- Stoop shall include a covered entry.
- Gates are not allowed.
- All doors shall face the street.

## 25.05.080 Forecourt



*Local example in the Downtown neighborhood*



*Local example in the Oak Park neighborhood*



*Local example in the West Beach neighborhood*

#### A. Description

A Forecourt is embedded in the front façade to create an uncovered and shared space for a main building entrance or serving multiple unit entrances. It is open to the sky except for allowed encroachments and can include a low fence or wall that separates it from the right-of-way. The Forecourt is distinct from a Community Open Space (Plaza) in that it occurs only once per design site and may not overlap with a Plaza.

A Forecourt may be combined with a Stoop (25.05.070), Maker Shopfront (25.05.090), Shopfront (25.05.100), Terrace (25.05.110), or Arcade (25.05.130).

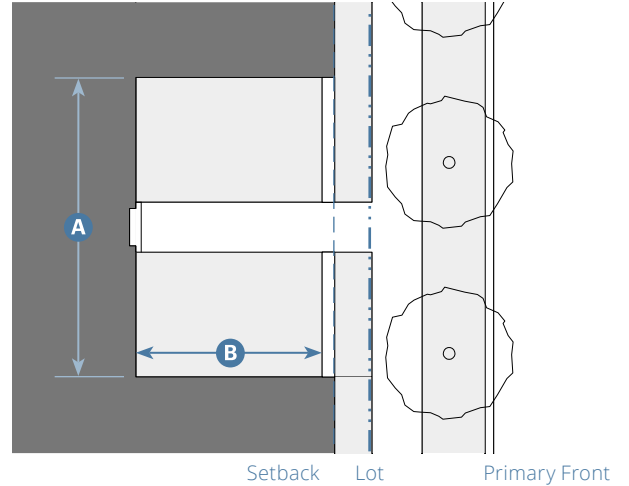
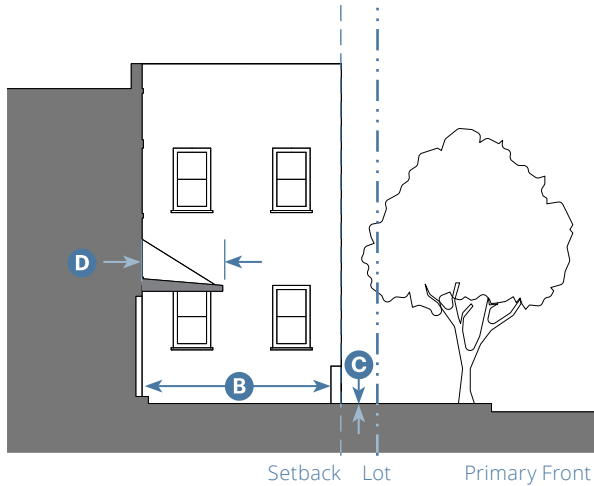

**Key**

- - - Lot/Design Site Line      ····· Setback Line

**B. Required Elements**

Width, Clear	25' min. if 3 stories; 35' min. if 4 stories; 50' max.	<b>A</b>
Depth, Clear	15' min.; 50' max.	<b>B</b>
Finish Level above Sidewalk	12" max.	<b>C</b>
Along the ground floor of the Forecourt, the following are allowed to encroach a total of 1/3 of the Forecourt's width: Stoop, Shopfront, Maker Shopfront, or Arcade.		<b>D</b>

**C. Additional Requirements**

- Forecourts may be utilized to group several entries at a common elevation in compliance with the zones' ground floor finish level standards.
- A 42" max. height fence or wall is allowed, using materials consistent with the main building.
- The Forecourt is not required to be open to the public.
- The Forecourt is included in the length of façade required within or abutting the façade zone.

25.05.090 Maker Shopfront



Local example in the Lower State neighborhood



Local example in the Lower State neighborhood



Local example in the Lower State neighborhood

**A. Description**

The Maker Shopfront is a nonresidential entrance from the right-of-way to the primary front or secondary front façade. It is intended for nonresidential uses to showcase their activity to pedestrians with large, transparent glazed areas. Alternatively, transparency can be accommodated with an overhead or sliding door.

A Maker Shopfront may be combined with a Dooryard (25.05.060), Forecourt (25.05.080), or Terrace (25.05.110).



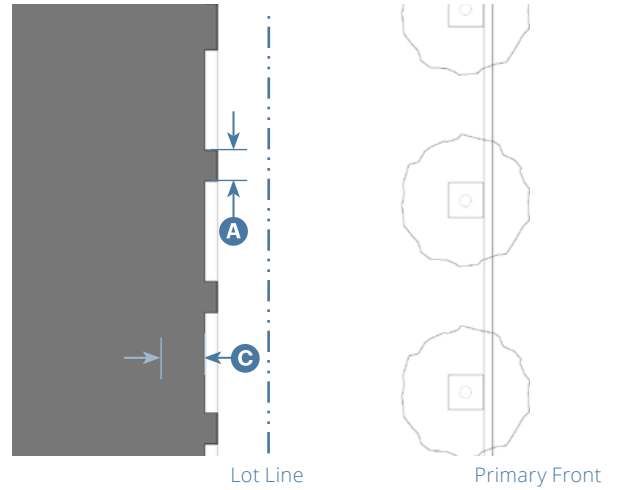
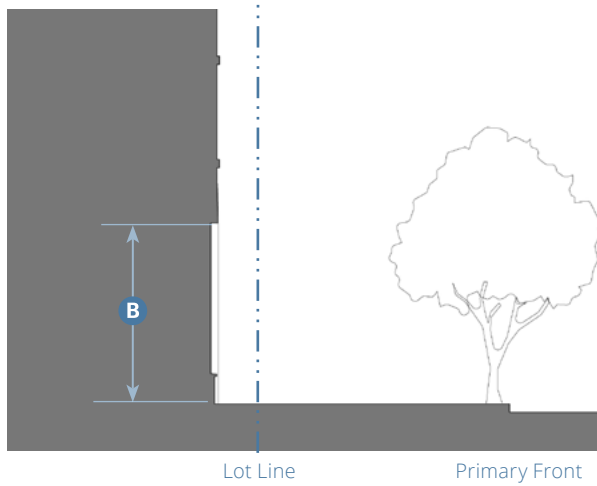

**Key**

--- Lot/Design Site Line      - - - - - Setback Line

B. Required Elements		
Distance between Glazing or Door	12' max.	<b>A</b>
Ground Floor Glazing between Sidewalk and Finished Ceiling Height	30% min.	<b>B</b>
Depth of Recessed Entries	No max.	
Shopfront Base/Bulkhead	48" max.	<b>C</b> <b>D</b>

**C. Additional Requirements**  
 The type is only allowed in the Contemporary Style Group. Overhead, folding, or sliding doors or operable windows that roll up and allow the space to open to the street are allowed.

25.05.100 Shopfront



Local example in the Downtown neighborhood



Local example in the Lower State neighborhood



Local example in the Downtown neighborhood

**A. Description**

The Shopfront is a nonresidential entrance from the right-of-way to the primary front or secondary front façade. It is intended for nonresidential uses to show their activity to pedestrians with a high level of transparency through substantial glazing.

A Shopfront may be combined with a Dooryard (25.05.060), Forecourt (25.05.080), Terrace (25.05.110), Gateway (25.05.120), or Arcade (25.05.130).

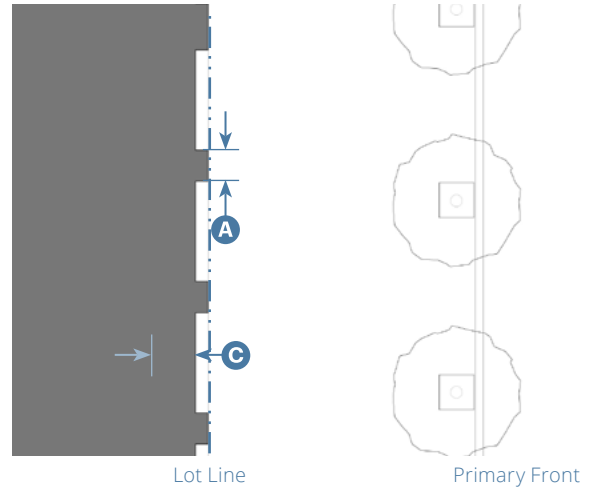
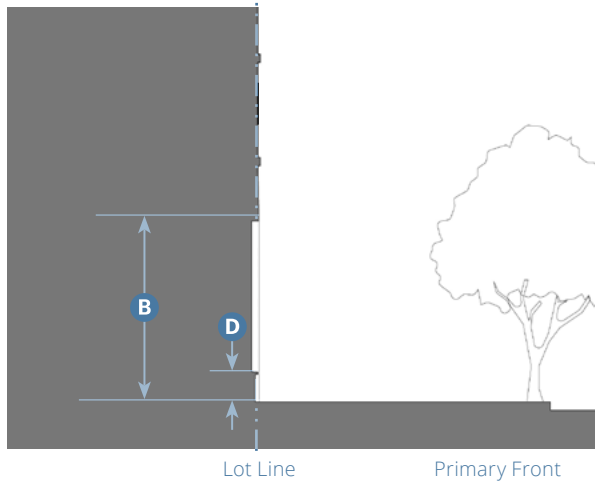

**Key**

- - - Lot/Design Site Line      ····· Setback Line

B. Required Elements		
Distance between Glazing	2' max.	<b>A</b>
Ground Floor Glazing between Sidewalk and Finished Ceiling Height	75% min.	<b>B</b>
Depth of Recessed Entries	5' max.	<b>C</b>
Shopfront Base/Bulkhead <sup>1</sup>	6" min.; 24" max.	<b>D</b>

<sup>1</sup> Not applicable to doors.

**C. Additional Requirements**

Operable doors and windows that do not roll up, but allow the space to open to the street, are allowed in compliance with Chapter 25.06 (Architectural Design).

25.05.110 Terrace



Local example in the Oak Park neighborhood



Local example in the Oak Park neighborhood

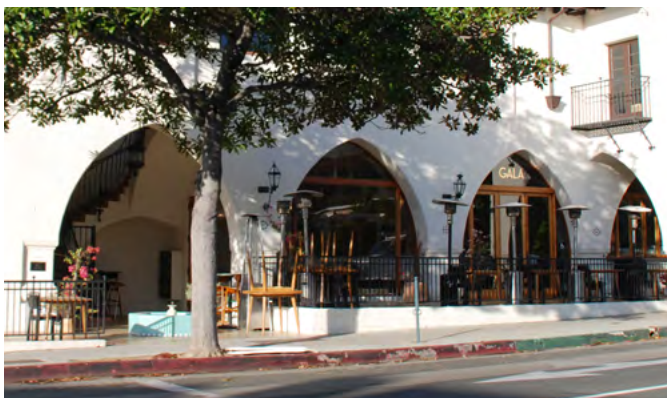

Local example in the Downtown neighborhood

A. Description

A Terrace is an elevated area abutting the right-of-way that provides pedestrian circulation to a main entrance along the primary front or secondary front façade or serving multiple unit entrances. It is accessible from the sidewalk corridor via stairs and ramps.

A Terrace may be combined with a Recessed Porch (25.05.050), Forecourt (25.05.080), Maker Shopfront (25.05.090), or Shopfront (25.05.100).

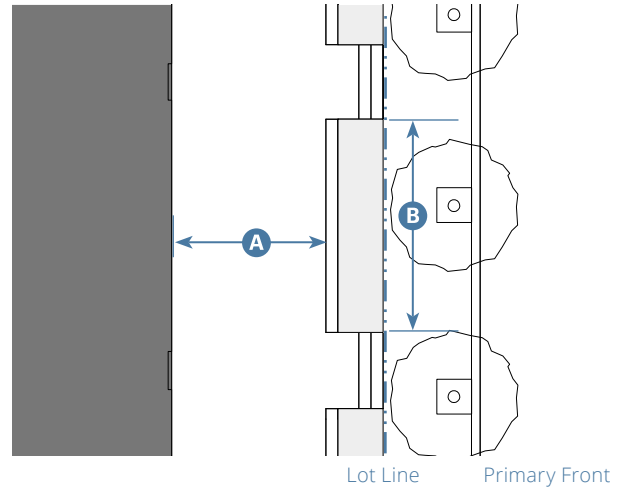
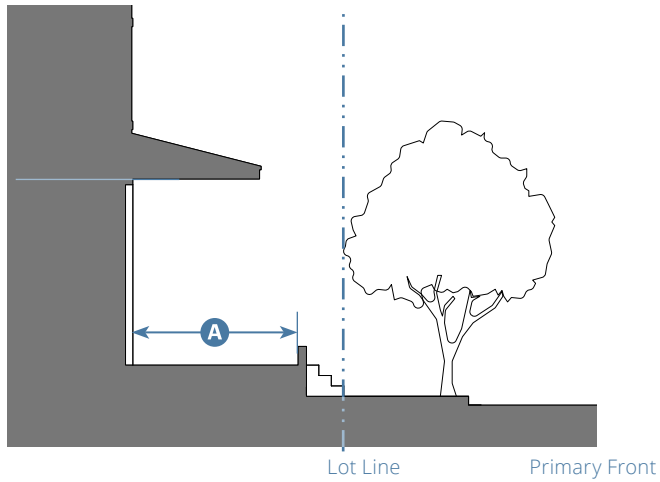

**Key**

- - - Lot/Design Site Line      ····· Setback Line

**B. Required Elements**

Depth of Terrace	6' min. residential; <b>A</b> 10' min. nonresidential; 15' max.
Finish Level above Sidewalk	36" max.
Distance between Stairs	25' max. <b>B</b>

**C. Additional Requirements**

All nonresidential ground floor Shopfronts that front onto the Terrace shall be accessed from the Terrace.  
A covered entry is allowed but not required.

25.05.120 Gateway



Local example in the East Beach neighborhood



Local example in the Upper East neighborhood



Local example in the Downtown neighborhood

A. Description

A Gateway links the right-of-way to an uncovered interior courtyard by way of a covered passage. Building entrances may occur in the interior courtyard or along the covered passageway.

A Gateway may be combined with a Shopfront (25.05.100).

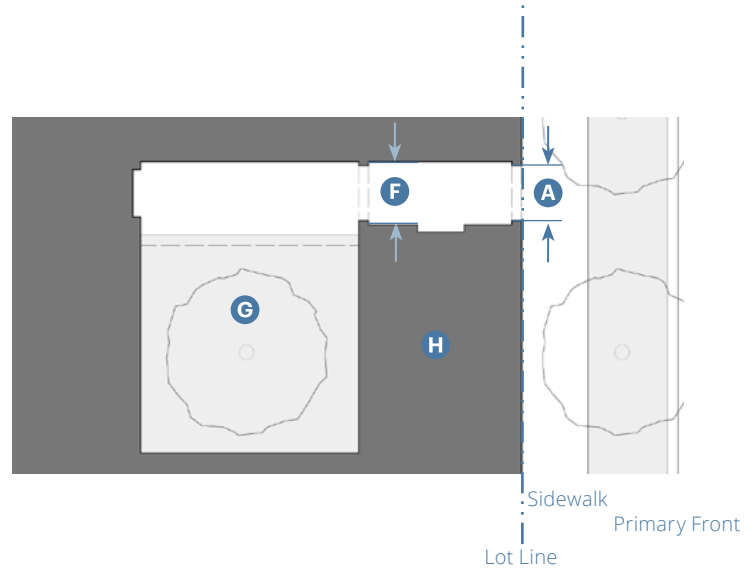
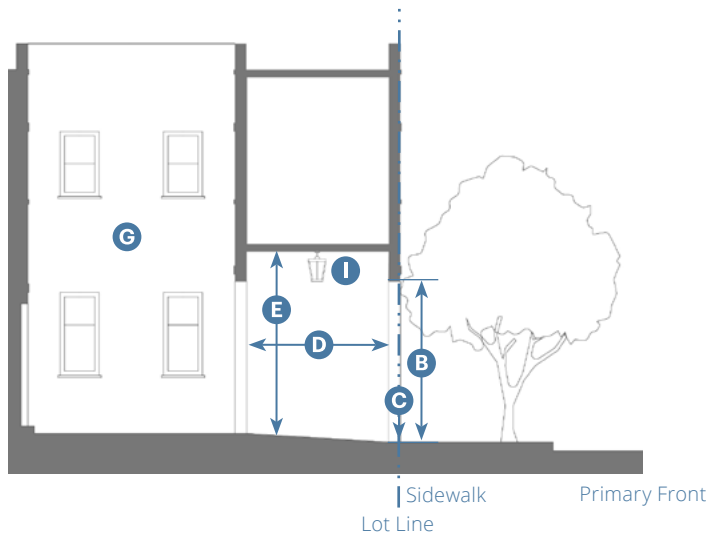

**Key**

- - - Lot/Design Site Line
- ..... Setback Line

B. Required Elements		
<b>Portal (into Passageway)</b>		
Width, Clear	6' min.; 12' max.	<b>A</b>
Height, Clear	10' min.; 20' max.	<b>B</b>
Finish Level above Sidewalk	24" max.	<b>C</b>
<b>Passageway (into Courtyard)</b>		
Depth, Clear	10' min.; 40' max.	<b>D</b>
Height, Clear	10' min.; 20' max.	<b>E</b>
Width, Clear	6' min.	<b>F</b>
<b>Courtyard</b>		
As required by Section 25.04.130 (Large Courtyard).		
		<b>G</b>

C. Additional Requirements	
Occupiable space is required between the Courtyard and right-of-way.	<b>H</b>
Lighting is required within the Gateway in compliance with Section 25.03.060 (Lighting).	<b>I</b>

25.05.130 Arcade



*Local example in the Oak Park neighborhood*



*Local example in the Downtown neighborhood*



*Local example in the Downtown neighborhood*

**A. Description**

An Arcade is a recessed, one-story pedestrian circulation area provided at grade that is articulated with a colonnade or arches that span the majority of the façade. It provides access to the main entrance along the primary front or secondary front façade.

An Arcade may be combined with a Forecourt (25.05.080) or Shopfront (25.05.100).



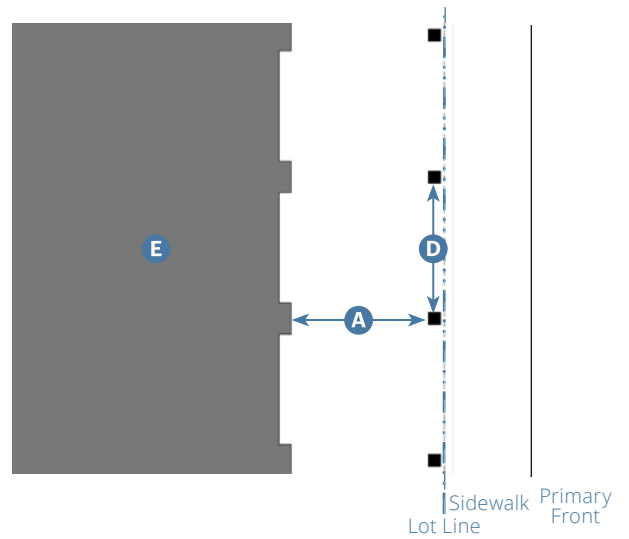
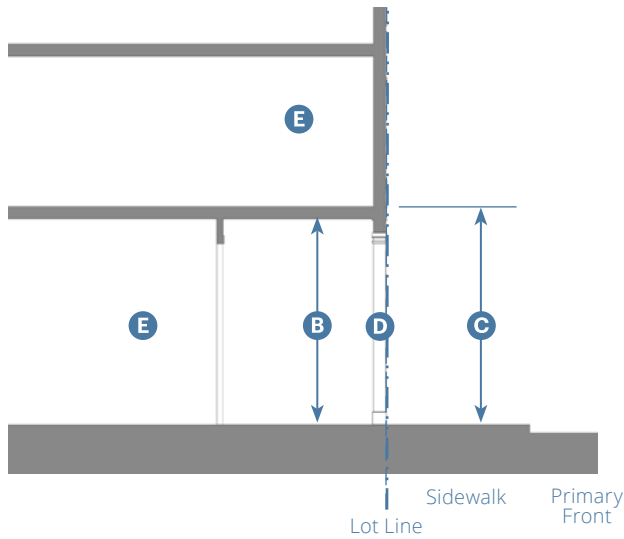

**Key**

- - - Lot/Design Site Line
- ..... Setback Line

**B. Required Elements**

Depth, Clear	10' min.; 20' max.	<b>A</b>
Ground Floor Height, Clear	12' min.	<b>B</b>
Height	1 story max.	<b>C</b>

**Columns & Openings**

Column Proportions (width to height)	1:4 min. <sup>1</sup> ; 1:8 max.	<b>D</b>
Column Diameter	1' min.; 2'-6" max.	
Opening Proportions (width to height)	1:1.6 min.; 1:2 max.	
Spacing Between Columns	10'-0" min.; 15'-0" max. on center	

The distance from the top of the arch to bottom of the next structural floor plate above shall be greater than the width of any supporting column and less than the radius of any arch.

<sup>1</sup> 1:5 min. for columns expressed with entasis.

**C. Additional Requirements**

- Occupiable space **E**
- Arcades shall have a consistent depth across the entire primary front and/or secondary front façade.
- Arcades shall occupy at least 50% of façade on lots over 50 feet wide; no minimum for lots 50 feet wide or less.
- Lighting is required within the Arcade in compliance with Section 25.03.060 (Lighting).

*This page intentionally left blank*

# Chapter 25.06 Architectural Design

---

## Sections:

25.06.010	Purpose
25.06.020	General Requirements
25.06.030	Quick Code Guide: Architectural Design Standards
25.06.040	Craftsman Style Group
25.06.050	Mediterranean Style Group
25.06.060	Contemporary Style Group

---

## 25.06.010 Purpose

This Chapter sets forth architectural design standards to further refine intended building form and physical character. The styles were created to be harmonious with Santa Barbara's distinctive built environment and were selected to represent the most prevalent existing architectural styles. The Architectural Styles Map requires certain styles in areas of the city including those that are highly visible to the public or adjacent to sensitive historic resources. These standards supplement the standards in Chapter 25.02 (Zones), Chapter 25.04 (Building Types), and Chapter 25.05 (Frontages).

---

## 25.06.020 General Requirements

- A. **Façades.** All façades shall be designed in compliance with the standards of this Chapter, Chapter 25.05 (Frontages), and Section 25.04.160 (Massing and Facade Composition).
1. Unless stated otherwise, all subsections within each architectural style group ('style') identified in this Chapter apply to all façades of a building, including primary front façades, secondary front façades, interior façades, and interior courtyard façades.
- B. **Architectural Styles.**
1. One architectural style shall be selected for each new building in compliance with Section 25.01.120 (Architectural Styles Map).
  2. Projects located in Historic Districts, Landmark Districts, or Potential Historic Districts are limited to the architectural styles required for that district, as described in either *Chapter 30.57 (Landmark District and Historic District Overlay Zone)*, or the *City's Historic Resource Design Guidelines*, as applicable. If an architectural style is required in a Historic District, Landmarks District, or Potential Historic District, but is not available in this Chapter, it is not allowed to be approved under this Title.
  3. Projects using styles not included in this Chapter are not allowed to be approved under this Title.
  4. The Industrial sub-style is limited to projects in the M-C Manufacturing Commercial or CO-CAR Coastal-Oriented Commercial, Arts, and Recreation base zones as shown on the Architectural Styles Map.
  5. All buildings on a single design site shall use the same style.

**C. Elements.**

1. Within each style, the standards for architectural elements apply to each architectural element wherever that element appears on a new building.
2. Individual element types (e.g., balconies, storefronts) or components (e.g., cornice, brackets) may be included or omitted on any given façade, but where included shall comply with the standards for the selected style, including the stated nominal dimensional standards.
3. Elements and components are required only where explicitly indicated.

**D. All Styles Requirements.** The following standards apply to each architectural style group.

1. Walls.
  - (a) Structural expansion joints shall be concealed by placement, color selection, or use of façade plane change.
  - (b) Stucco wall finish shall extend below the weep screed, flush with the wall surface above, and continue for a minimum of two inches below finish grade.
  - (c) Wall flashing to be anodized or painted to match wall, trim, or other main color of the building.
2. Skylights.
  - (a) Skylights shall be curb or deck mounted in line with the roof pitch. Domed skylights are not allowed.
  - (b) Skylights shall not be publicly visible. Skylights may be screened by the building form, landscape, or parapet.
3. Windows
  - (a) Glazing divisions shall be positioned exterior to glass panes.
4. Dimensions. Lumber dimensions for trellises and carports are nominal.
5. Materials and Colors
  - (a) Wood and composite wood shall be stained, sealed, or painted.
  - (b) Where used, metal shall be painted or treated to prevent shiny or reflective finishes.
  - (c) Paint, textile, and metal colors shall be selected from the *Santa Barbara Guide: A Guide to Painting Buildings*.
  - (d) Wrought iron shall have a minimum one-half-inch cross section.

## 25.06.030 Quick Code Guide: Architectural Design Standards

### Before you begin

Identify your zone. If you have not done this yet, go back to the Quick Code Guide: Development Standards (Section 25.01.130).

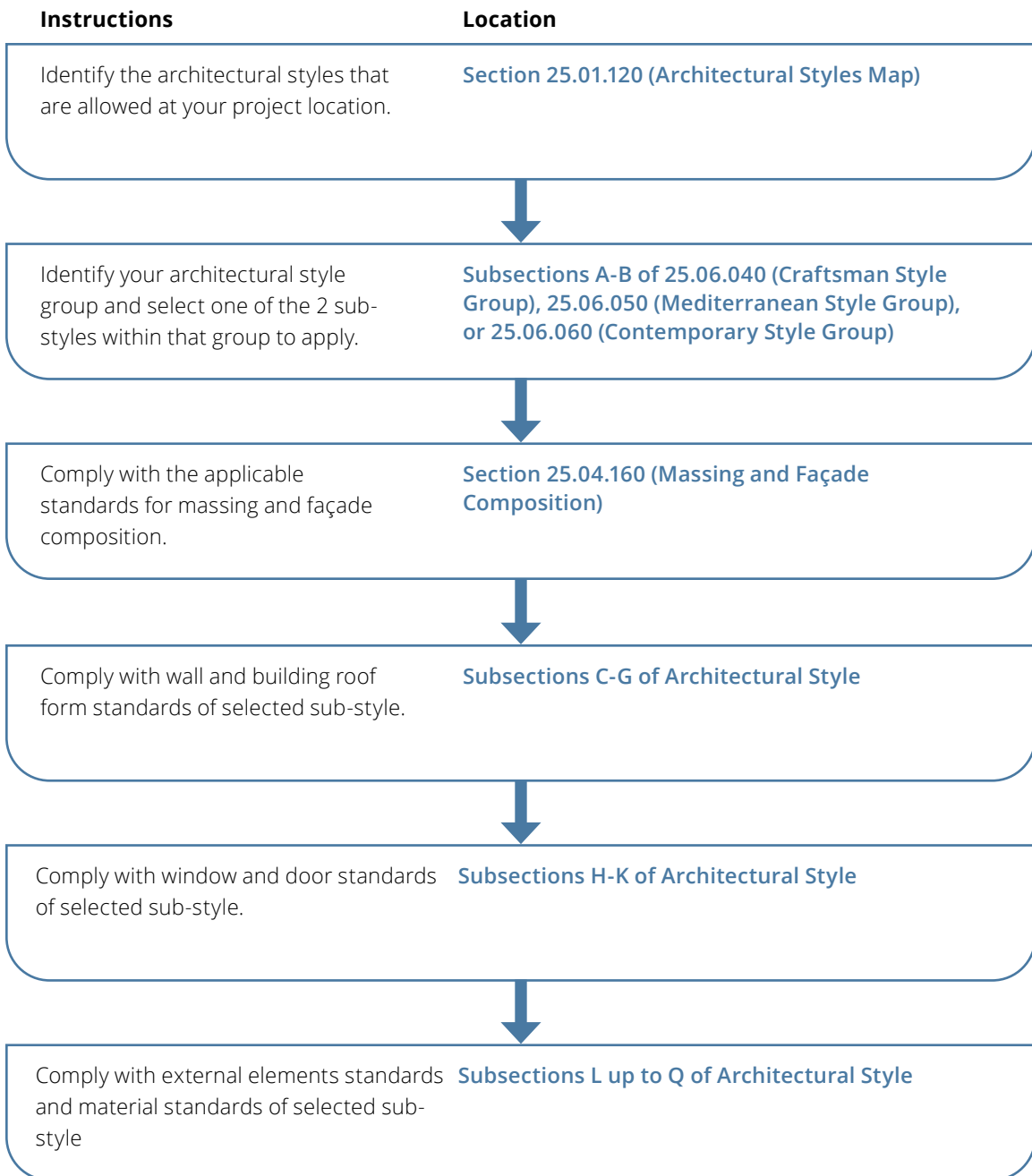

## 25.06.040 Craftsman Style Group



### A. General Description

#### Craftsman Sub-Style

The Craftsman style emerged in the American west and was inspired by the English Arts and Crafts movement. The Craftsman bungalow house was prevalent from the 1900s to the 1940s. Since that time, it has been adapted to multi-unit and mixed-use prototypes.

#### Cottage Sub-Style

Prevalent in the early 20th century, the Cottage style, like Craftsman, was influenced by the English Arts and Crafts movement and its affinity for pre-industrial models. In Santa Barbara, the Cottage style accommodates a range of primarily Northern European vernacular expressions. Windows, bay windows, balconies, porches, and materials are based on elements used in these traditions.



**B. Character Description: Craftsman**

- Massing of two and a half stories or less
- Low-pitched roofs with deep eaves and exposed rafter tails
- Horizontally proportioned openings made from ganged vertical windows
- Emphasis on natural-appearing materials, including composite wood shingles
- Asymmetrical composition with wall plane broken by projecting gable ends
- Wall plane broken by projecting and/or recessed elements

**B. Character Description: Cottage**

- Massing of two and a half stories or less
- Asymmetrical massing with front-facing gables
- Steeply-pitched shingle roof with low eaves; minimal projection at eave and rake
- Windows with evenly-spaced divided lites
- Stucco walls with or without half-timbering
- Mix of arched doors and square, though occasionally segmented arched, windows

# Elements of Craftsman Style



Example Building Elevation: Craftsman

C.1 Wall: Craftsman	
<b>Height Limitation</b>	
Building Height	2.5 stories max.
<b>Trim<sup>1</sup></b>	
Width	6" min. <span style="float: right;">(A)</span>

<sup>1</sup>Trim not required on portions of buildings where stucco, masonry, or stone is the primary wall material.

C.1. Wall: Craftsman (Continued)	
<b>Base</b>	
Height	1'-0" min.; 1 story max. <span style="float: right;">(B)</span>
Required	Projecting Profile/Molding <span style="float: right;">(C)</span>
Articulation	

Base is required for this sub-style.



# Elements of Cottage Style

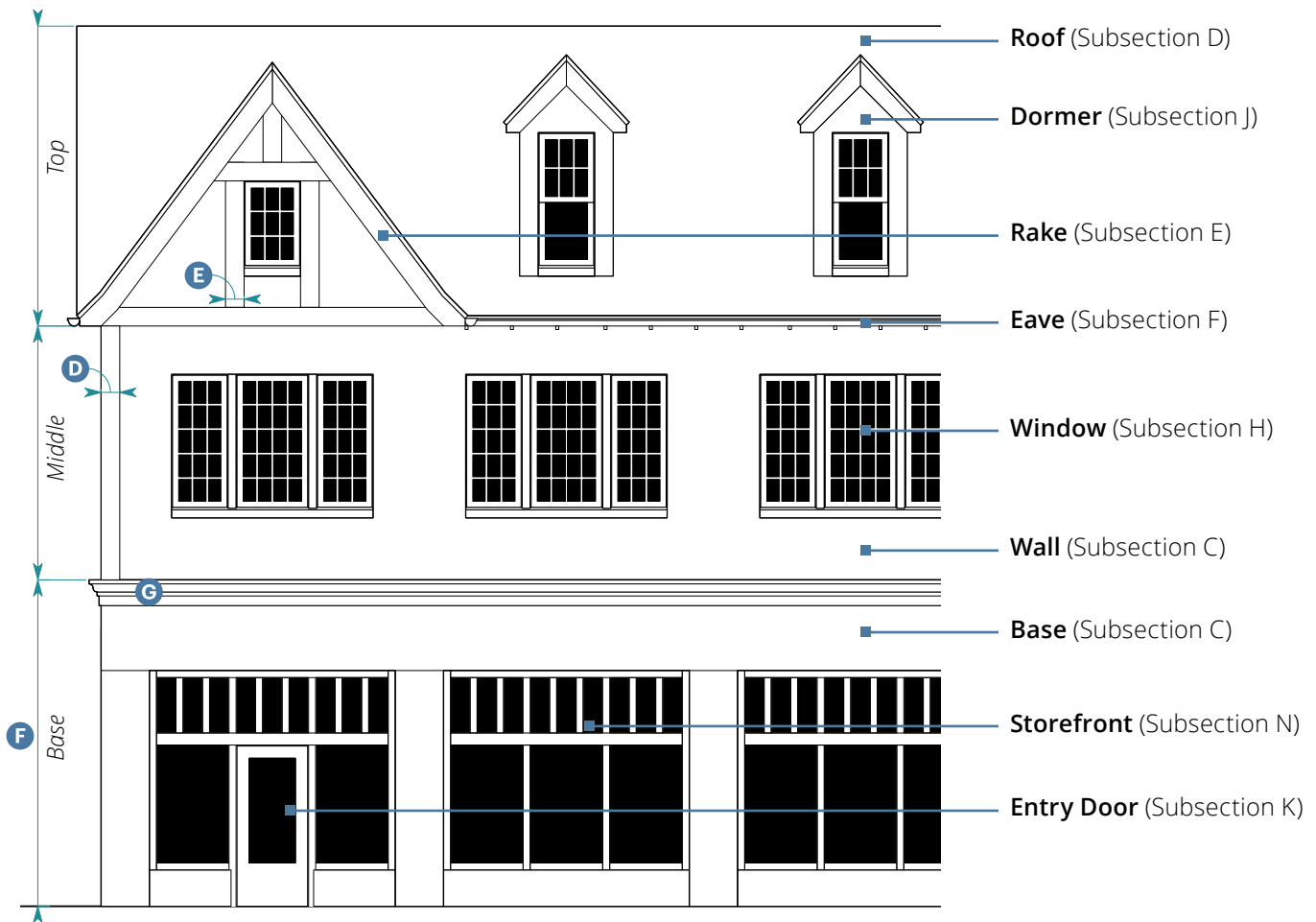

Example Building Elevation: Cottage

## C.2. Wall: Cottage

### Height Limitation

Building Height 2.5 stories max.

### Trim<sup>2</sup>

Edge Trim Width 4" min. **D**

Half-Timbering Width 8" min. **E**

## C.2. Wall: Cottage (Continued)

### Base

Height 1 story max. **F**

Required Articulation Projecting Profile/Molding **G**

Base is not required for this sub-style.

<sup>2</sup>Trim not required on portions of buildings where stucco, masonry, or stone is the primary wall material.

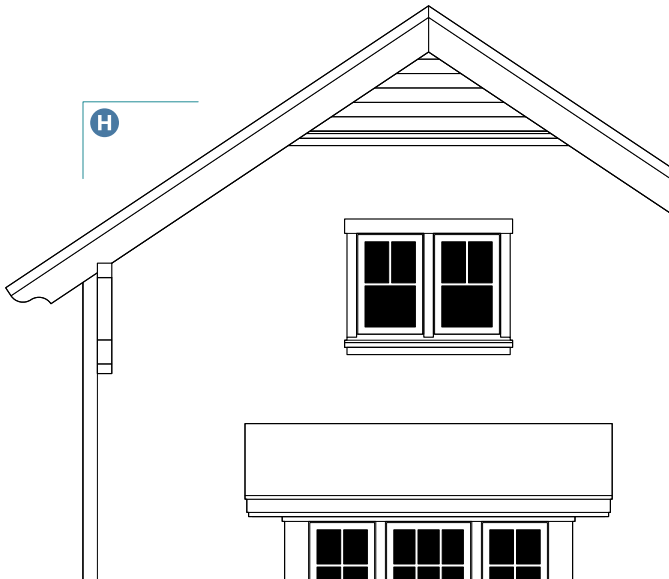

Gable End Elevation

**D.1. Building Roof: Craftsman**

Roof Form	
Type	Gable, Hip, Shed <sup>3</sup>
Pitch	3:12 min.; 8:12 max. <span style="float: right;">(H)</span>

<sup>3</sup> High side of shed roof must terminate into wall.

**D.2. Building Roof: Cottage**

Roof Form	
Type	Gable, Shed <sup>4</sup>
Pitch	8:12 min. <span style="float: right;">(H)</span>

<sup>4</sup> High side of shed roof must terminate into wall.

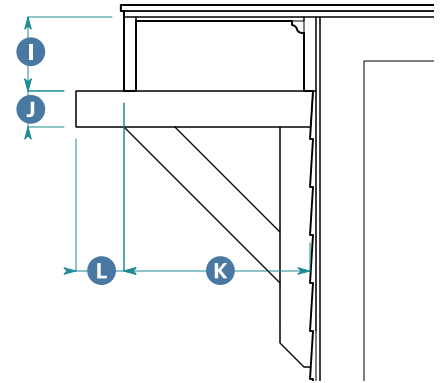

Rake Section: Craftsman with Bracket

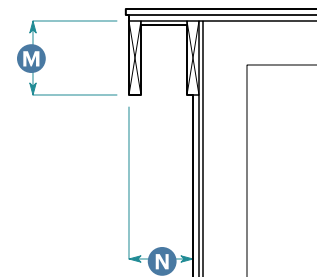

Rake Section: Cottage

**E.1. Rake: Craftsman**

Height		
Fascia	10" min.	(I)
Bracket Bracing Member	4" min.	(J)
Horizontal Projection		
To Fascia: Main Roof Form	1'-8" min. 3'-0" max;	(K)
To Fascia: Dormer	8" min. 1'-2" max;	(K)
Bracket Projection Beyond Fascia	No min.; 1'-0" max.	(L)

**E.2. Rake: Cottage**

Height		
Fascia	8" min.	(M)
Horizontal Projection		
Projection to Fascia	8" min.	(N)

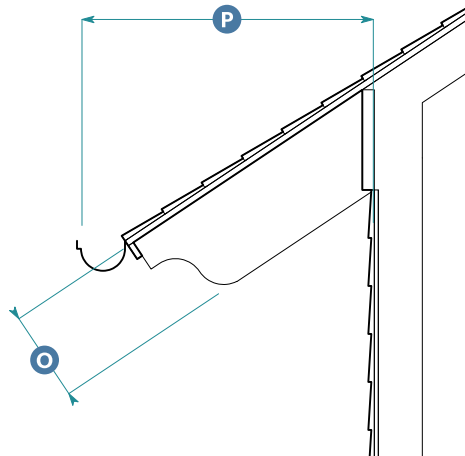

Open Eave Elevation: Craftsman

F.1. Eave: Craftsman			
Standards	Open Eave	Closed Eave	
<b>Height</b>			
Rafter	8" min.	N/A	O
<b>Horizontal Projection<sup>5</sup></b>			
Main Roof Form	2'-6" min.	N/A	P
Dormer	8" min.	N/A	P

<sup>5</sup>Horizontal projection includes gutter, where occurs.

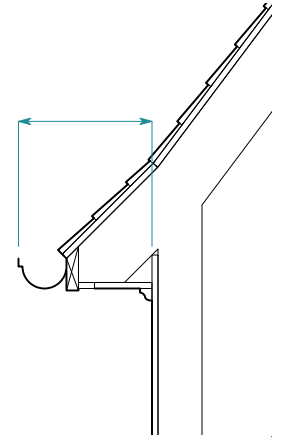

Closed Eave Elevation: Cottage

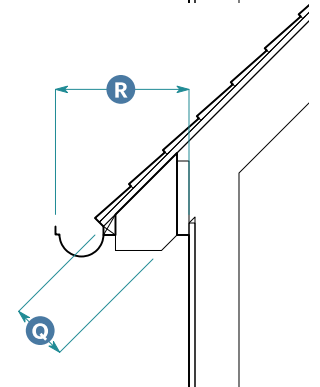

Open Eave Elevation: Cottage

F.2. Eave: Cottage			
Standards	Open Eave	Closed Eave	
<b>Height</b>			
Rafter	8" min.	N/A	Q
<b>Horizontal Projection<sup>6</sup></b>			
Overall	1'-0" min.	1'-0" min.	R

<sup>6</sup>Horizontal projection includes gutter, where occurs.

**G. Parapet: All**

Flat roofs with parapets are not allowed in this style group. See Subsection E (Rake) and Subsection F (Eave) for standards applicable to sloped roofs.

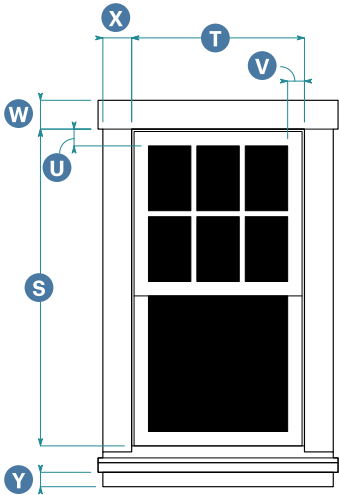

Typical Window Elevation: Craftsman (Shown with 6 over 1 Glazing Division)

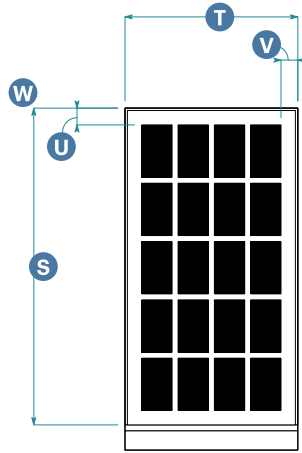

Typical Window Elevation: Cottage (Shown with 20 Parts Glazing Division)

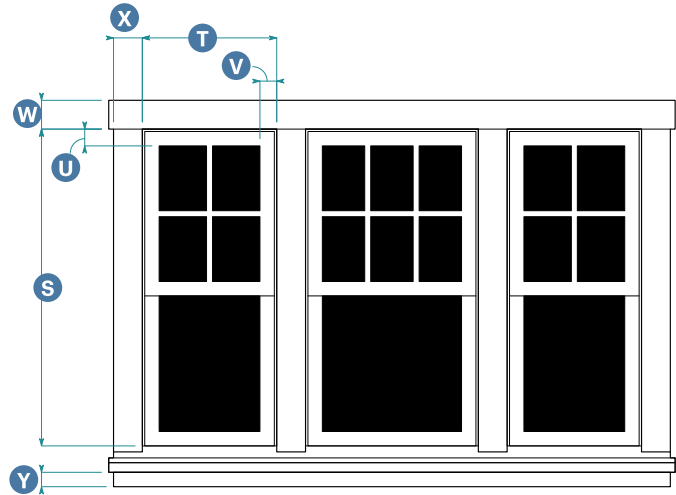

Ganged Window Elevation: Craftsman with 4 over 1 and 6 over 1 Glazing Divisions

**H. Windows: All**

**Opening Proportion, Height **S** to Width **T****

Typical Window	
Ground Floor	2:1 min.
Typical Upper Floor	7:4 min.
Accent Window	
Rectangle	3:2 min. (2'-6" max. width)
Square	1:1 min. (3'-0" max. width)
Ganged Window	3:5 min.
Picture Window	6:5 min.
Dormer Window	7:4 min.

**Window**

Sash Widths		
Rail	2" min.	<b>U</b>
Stile	2" min.	<b>V</b>
Trim Widths <sup>7</sup>		
Head	6" min.	<b>W</b>
Jamb	6" min.	<b>X</b>
Apron	3" min.	<b>Y</b>

**H. Windows: All (Continued)**

**Window Frame Recess**

Depth	2" min. from face of surround to face of sash
-------	---

**Sill Projection**

Depth	2" min. from face of surround
-------	-------------------------------

**Pediment**

Allowed	No
---------	----

**Mullions**

Mullions required between ganged windows.

<sup>7</sup>Trim required for windows only on buildings or parts of buildings with lap siding.

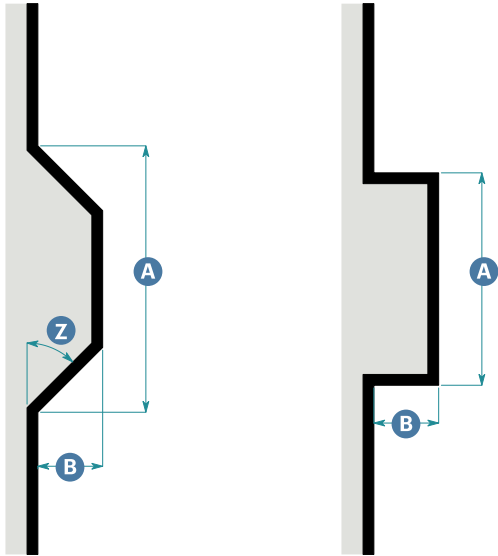

Bay Window Plan: Chamfered

Bay Window Plan: Square

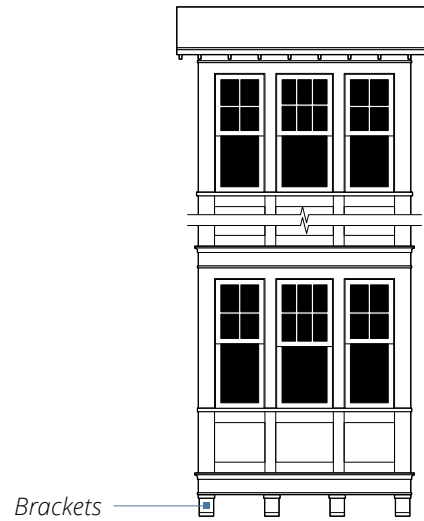

Bay Window Elevation

**H.1. Windows: Craftsman**

**Opening**

Shape Rectangular

**Window**

Operation Double-Hung, Single-Hung, Awning, Casement, Fixed

Glazing Divisions 4 over 1, 6 over 1, or 10 over 1

Width of lites shall be no greater than their height.

**H.2. Windows: Cottage**

**Opening**

Shape Rectangular, Arched

**Window**

Operation Double-Hung, Single-Hung, Awning, Casement, Fixed

Glazing Divisions 6 parts min.;  
24 parts max.

Width of lites shall be no greater than their height.

**I. Bay Windows: All**

**Form**

Type Square, Chamfered

Interior Angle for Chamfered Form 30 degrees min.; 55 degrees max. **Z**

Continuous horizontal articulation on building shall wrap bay window form.

**Dimensions**

Width 6'-0" min.; 12'-0" max. **A**

Depth 1'-0" min.; 4'-0" max. **B**

Bay window that does not extend to grade shall be supported on brackets.

Bay window form shall be vertically continuous from lowest bay window to highest bay window.

**Allowed Cornice Treatments**

Bay window stops below building eave (provide roof or cornice for bay window).

**Corner Placement**

At building corner, square bay window may be rotated 45 degrees.

When wrapping a corner, chamfered bay window may incorporate up to five faces instead of the typical three.

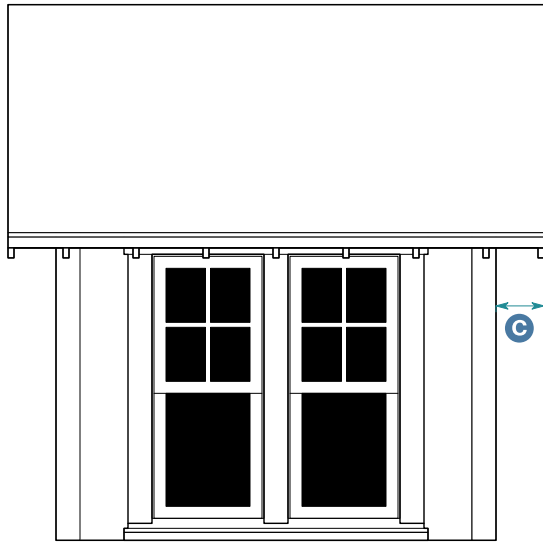

Dormer Elevation: Craftsman

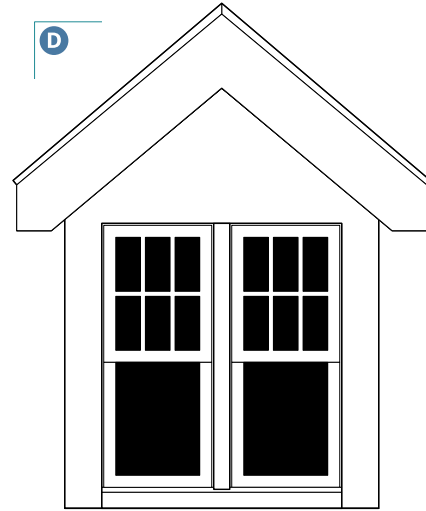

Dormer Elevation: Cottage Shown with Gable Roof

**J.1. Dormers: Craftsman**

**Roof Form**

Type	Shed
Pitch	3:12 min.; 7:12 max.

**Horizontal Projection**

Rake	See Subsection E.1 (Rake) for rake standards. <b>C</b>
Eave	See Subsection F.1 (Eave) for eave standards.

**Placement**

Setback from Side Façade	3'-0" min.
Setback from Façade to Face of Dormer	1'-0" min.
Dormers shall not interrupt continuity of main building roof eave.	

**Window**

See Subsection H (Windows) for window standards.

**J.2. Dormers: Cottage**

**Roof Form**

Type	Gable, Hip
Pitch	6:12 min.; 10:12 max. <b>D</b>

**Horizontal Projection**

Rake	See Subsection E.2 (Rake) for rake standards.
Eave	See Subsection F.2 (Eave) for eave standards.

**Placement**

Setback from Side Façade	3'-0" min.
Setback from Façade to Face of Dormer	1'-0" min.
Dormers shall not interrupt continuity of main building roof eave.	

**Window**

See Subsection H (Windows) for window standards.

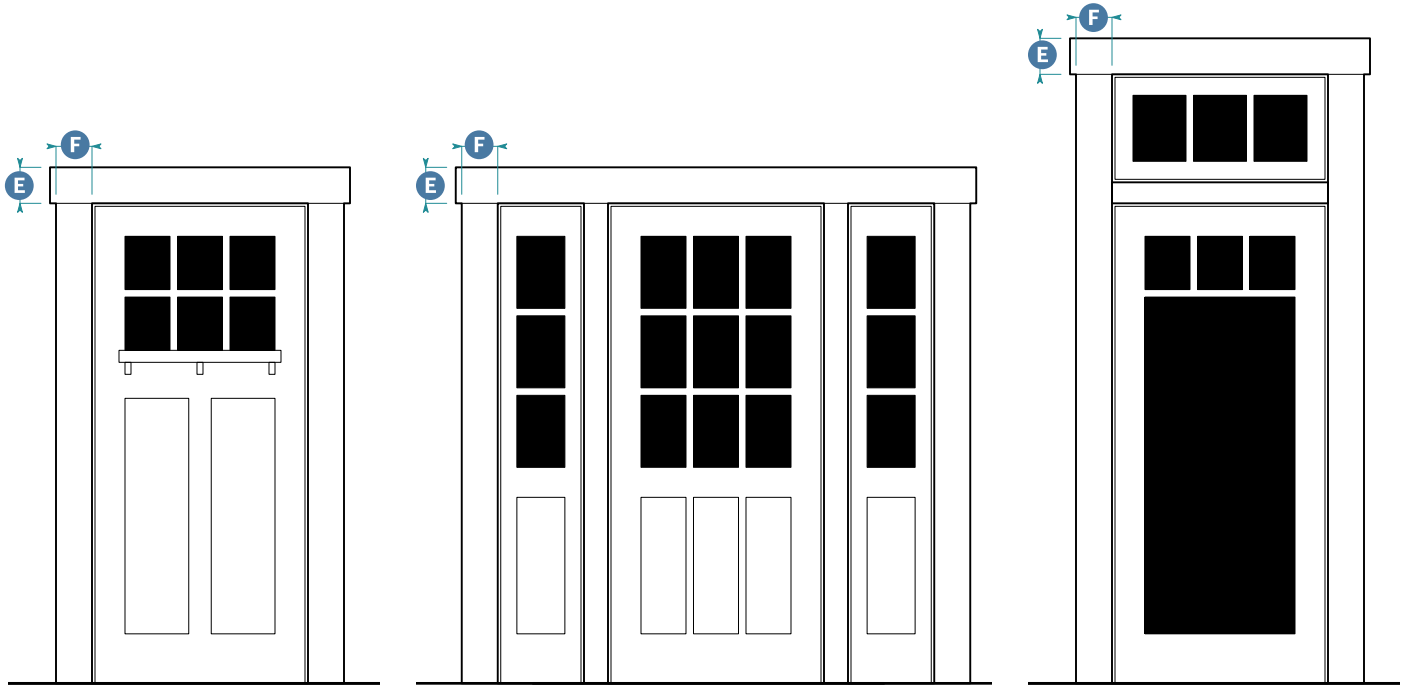

Vision Glass Door Elevation with Two Panels and Square Span

Half Glass Door Elevation with Three Panels and Sidelights

Full Glass Door Elevation with Transom: Craftsman

**K.1. Entry Doors: Craftsman**

**Door**

Number of Panels 2 min.<sup>8</sup>

**Lite Types/Glazing Divisions**

Vision Glass 3 parts min.

Half Glass 6 parts min.

Full Glass 3 parts min. over 1

**Surround**

Span Type Lintel

Head Width 6" min. **E**

Jamb Width 4" min. **F**

**Glazed Openings**

Transom Allowed

Sidelights Allowed

**Placement**

No portion of door shall be allowed within 1'-6" of outside corners of building.

Doors shall be centered along width of balconies and arches, where occurs.

<sup>8</sup> Panels not required for full glass lite type.

**K.2. Entry Doors: Cottage**

**Door**

Number of Panels 2 min.<sup>9</sup>

**Lite Types/Glazing Divisions**

Vision Glass 4 parts min.

Half Glass 8 parts min.

Full Glass 16 parts min.

**Surround**

Span Type Lintel, Arch

Head Width 6" min. **E**

Jamb Width 4" min. **F**

**Glazed Openings**

Transom Allowed

Sidelights Allowed

**Placement**

No portion of door shall be allowed within 1'-6" of outside corners of building.

Doors shall be centered along width of balconies and arches, where occurs.

<sup>9</sup> Panels not required for full glass lite type.

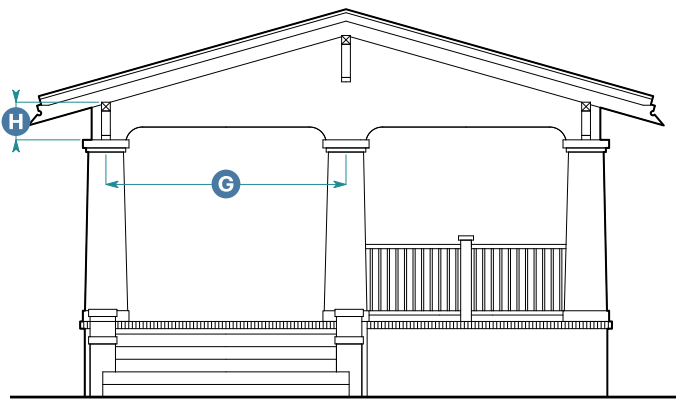

One-Story Porch with Square Tapered Column and Capital Connection: Craftsman

**L.1. Columns/Pilasters: Craftsman**

**Columns + Pilasters**

Shape	Square, Square Tapered
Width/Diameter	9" min. each
Spacing	9'-6" min., 12'-0" max. on center <b>G</b>
Pedestal Height <sup>10</sup>	3'-0" min.
Entablature/Beam Connection	Capital, Mortise and Tenon

Columns may be paired.  
Columns must not span multiple stories.

**Additional Features**

Paneling	Allowed
Fluting	Not Allowed

**Entablature Height**

Topmost Floor	1'-6" min. <b>H</b>
Intermediate Floor	10" min.

**Guard/Railing**

Allowed Types	Square, Flat Sawn
Width Between Posts	3'-0" min. on center

<sup>10</sup> Pedestal may be omitted.

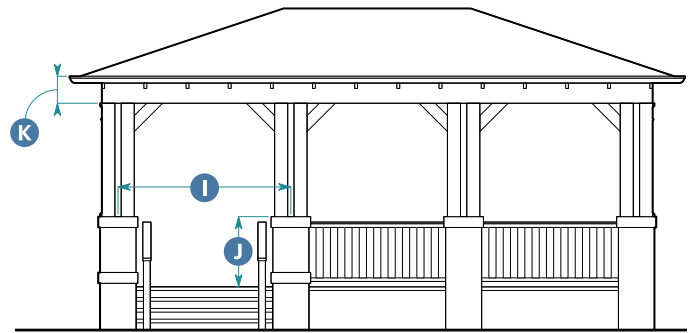

One-Story Porch with Paired Square Columns on Pedestals and Mortise and Tenon Connection: Cottage

**L.2. Columns/Pilasters: Cottage**

**Columns + Pilasters**

Shape	Square
Width/Diameter	6" min. each
Spacing	8'-0" max. on center <b>I</b>
Pedestal Height <sup>11</sup>	3'-0" min. <b>J</b>
Entablature/Beam Connection	Capital, Mortise and Tenon

Columns may be paired.  
Columns must not span multiple stories.

**Additional Features**

Paneling	Allowed
Fluting	Not Allowed

**Entablature**

Topmost Floor	1'-6" min. <b>K</b>
Intermediate Floor	10" min.

**Guard/Railing**

Allowed Types	Square, Flat Sawn
Width Between Posts	3'-0" min. on center

<sup>11</sup> Pedestal may be omitted.



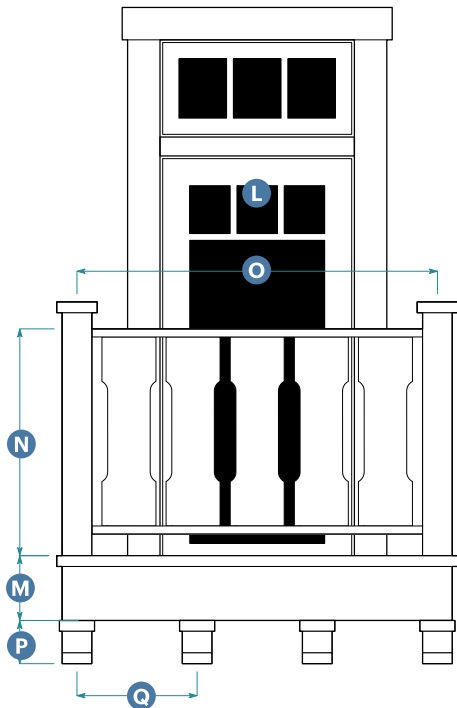

Juliet Balcony with Flat Sawn Railing, Front Elevation

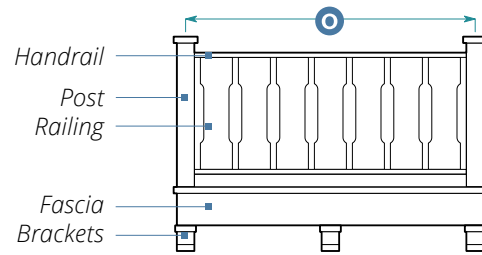

Occupiable Balcony with Flat Sawn Railing, Front Elevation

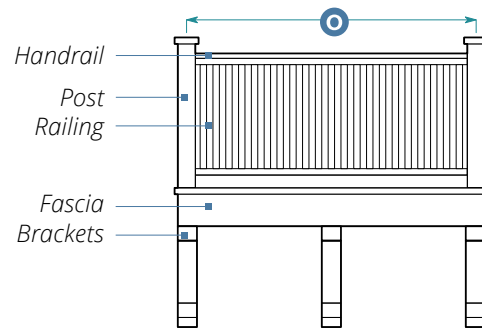

Occupiable Balcony with Square Railing, Front Elevation

**M. Balconies: All**

**Allowed Types**

**Type 1 - Juliet Balcony**

Inward-swinging door with full glazing required	L
Base Height	3" min. M
Base Projection	4" min.; 2'-0" max.

**Type 2 - Occupiable Balcony**

Clear Depth	6'-0" min.
Area	48 sq. ft. min.
Recess into Façade	4'-6" max.
Overall Width	10'-0" max.

**M. Balconies: All (Continued)**

**Guard/Railing**

Allowed Types	Square, Flat Sawn
Height	Per Building Code N
Width Between Posts	3'-0" min. on center O

**Brackets/Supports**

Allowed Types	Brackets, Cantilevered Beams
Depth	80% of projection depth at bracket, min.
Height	50% of bracket depth, min. P
Spacing	6'-0" on center, max. Q

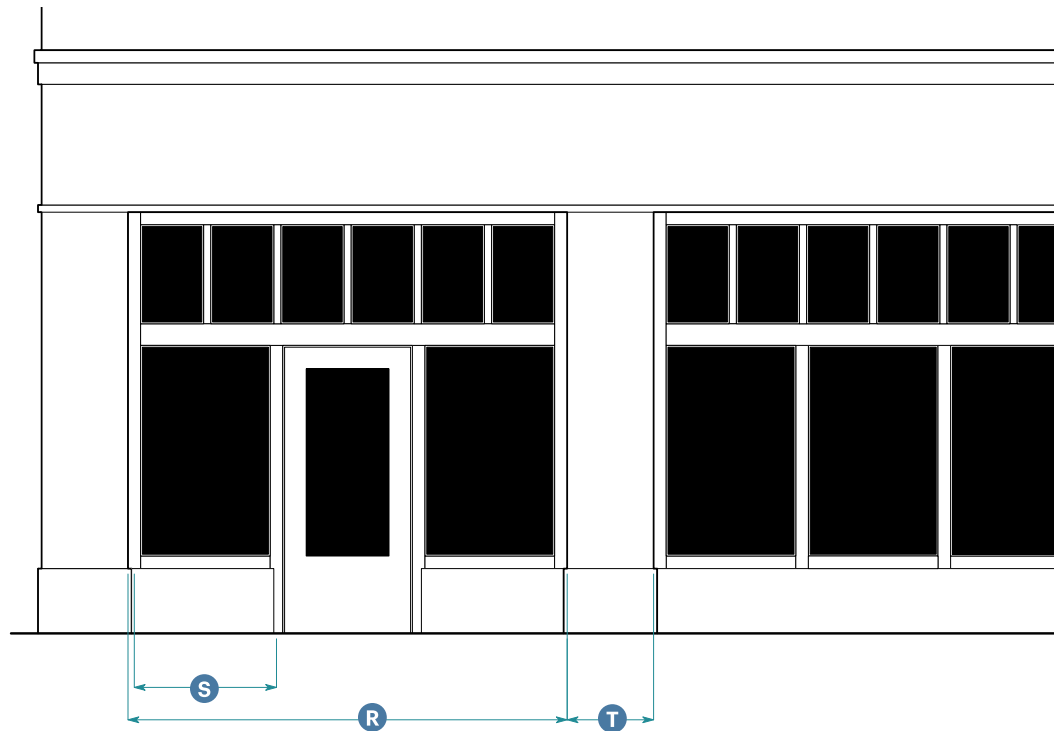
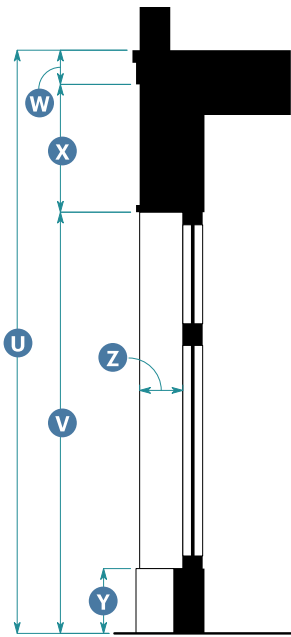

Storefront Section

Storefront Elevation

N. Storefronts: All		
<b>Width</b>		
Storefront Module <sup>12</sup>	10'-0" min.; 25'-0" max.	<b>R</b>
Display Window	3'-0" min.; 6'-0" max.	<b>S</b>
Distance Between Storefront Modules	1'-0" min.; 6'-0" max.	<b>T</b>
<b>Height</b>		
Overall	13'-0" min.	<b>U</b>
Head Height	10'-0" min.	<b>V</b>
Cornice	10" min.	<b>W</b>
Signage Band	1'-6" min.	<b>X</b>
Bulkhead	1'-0" min.; 2'-0" max.	<b>Y</b>
<b>Horizontal Recess</b>		
Depth	6" min.; 1'-0" max. <sup>13</sup>	<b>Z</b>
Bulkhead shall be continuous, unless divided by pilaster, and align with base height of building (if any).		
Cornice shall be continuous.		

<sup>12</sup> May be expressed as a pilaster. See Subsection L (Columns/Pilasters)

<sup>13</sup> No max. depth for residential entries.

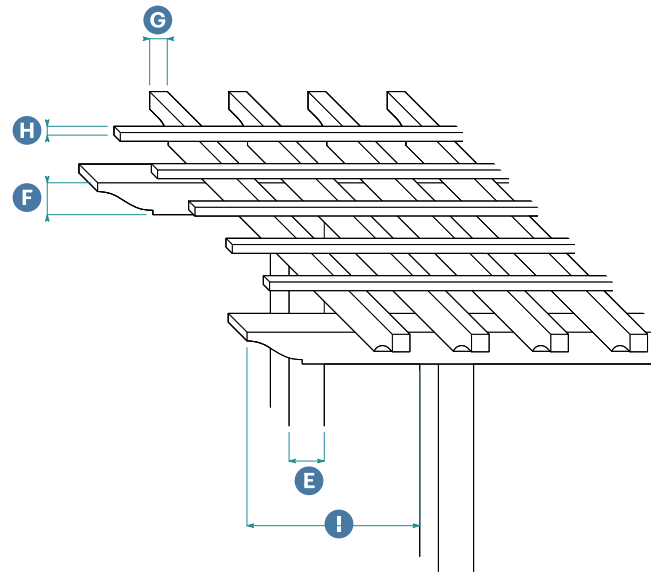
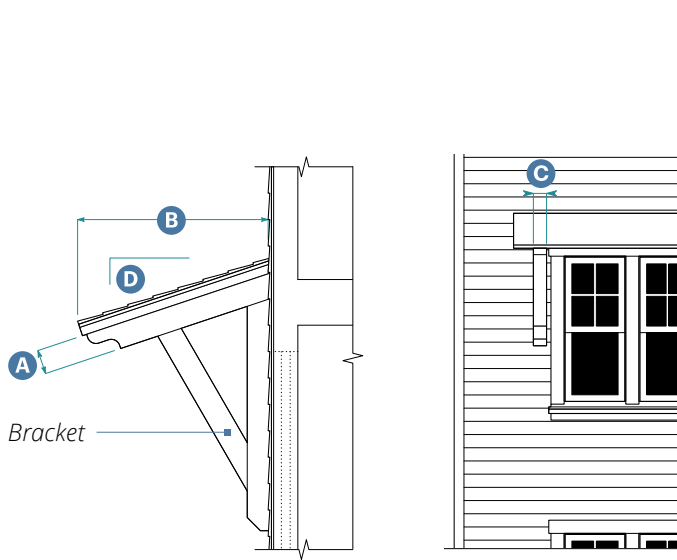

Awning Section: Craftsman

Awning Elevation: Craftsman

Trellis Diagram

O. Awning: All		
Awning		
Eave Height	6" min.	A
Horizontal Projection <sup>14</sup>	3'-0" min.	B
Required Support Elements	Brackets	
Bracket Width	4" min.	C
Roof Pitch	3:12 min.	D

<sup>14</sup> Horizontal projection includes gutter, where occurs.

P. Trellises and Carports: All		
Dimensions		
Post	8" x 8" min.	E
Main and Cross Beam	4" x 8" min. <sup>15</sup>	F
Rafter	2" x 4" min.	G
Purlin or Lattice	2" x 2" min.	H
Overhang		I
Beams	3'-0" max.	
Purlin or Lattice	2'-0" max.	
Trellis	1'-6" max.	

<sup>15</sup> Paired 2" x 8" members are allowed when placed on both sides of the supporting posts.

Q.1. Materials: Craftsman	
Element	Allowed Materials
<b>Building Walls</b>	
Cladding	Shingle or lap siding (wood, composite wood, fiber cement), stucco
Base or Foundation	Stucco, stone, cast stone, colored or painted concrete
<b>Roof and Roof Elements</b>	
Roofing	Shingles (composite wood, slate, dimensional or luxury asphalt shingles to mimic the look of wood or slate); standing seam metal (black, white, or reflective metal finishes are prohibited)
Rake and Eave	Wood, composite wood
Cornice	Wood, composite wood
Brackets	Wood, composite wood, fiberglass
Gutter	Half-round copper, metal
<b>Windows, Bay Windows, and Entry Doors</b>	
Trim or Surround	Wood, composite wood, fiber cement
Entry Door	Wood, composite wood, aluminum-clad wood, fiberglass
Window Frames	Wood, aluminum-clad wood
Glazing	Clear glass; shall not be tinted, mirrored, or colored
<b>Garages</b>	
Garage Door <sup>16</sup>	Wood, composite wood, fiberglass
<b>Balconies</b>	
Post, Handrail, Fascia, and Support Members	Wood, composite wood, solid metal
Railing	Wood, composite wood, metal
<b>Porches</b>	
Columns	Wood, composite wood, sandstone, metal
Railing	Wood, composite wood, solid metal

Q.1. Materials: Craftsman (Continued)	
Element	Allowed Materials
<b>Storefronts</b>	
Storefront Module	Wood, composite wood, metal, fiberglass
Storefront Base (Bulkhead)	Wood, brick, stone, tile, fiber cement
<b>Chimneys</b>	
Cap	Copper, steel
Body	Brick, stone, cast stone (including veneers of any of the above)
<b>Exterior Building Lighting</b>	
Body and Mount	Wrought iron, metal
Shield	Clear, translucent, punched, louvers
<b>Stairs and Ramps</b>	
Treads and Risers	Wood, composite wood, stucco, brick, stone
Handrails	Wood, composite wood, stucco, stone, wrought iron, metal
<b>Trellises and Carports</b>	
Spanning Members	Wood, composite wood
Trellis Posts	Wood, composite wood
Carport Support Posts	Wood, composite wood, stucco
<b>Trash Enclosure</b>	
Walls	Wood, composite wood, stucco
<b>Fences and Hedges</b>	
Walls	Stucco, brick, stone (faux manufactured stone veneer is prohibited), concrete block (coated and painted or pigmented to match the main building)
Fences <sup>17</sup>	Wood, composite wood, wrought iron, metal, chain link (vinyl-coated black or green)

<sup>16</sup> Metal roll up doors are allowed only if not publicly visible.

Metal security grilles are allowed for parking structures.

<sup>17</sup> Publicly visible fences may not be chain link unless screened with vines.

Q.2. Materials: Cottage	
Element	Allowed Materials
<b>Building Walls</b>	
Cladding	Wood, composite wood, stucco, brick, stone, fiber cement
Base or Foundation	Stucco, brick, stone, cast stone, colored or painted concrete
<b>Roof and Roof Elements</b>	
Roofing	Shingles (composite wood, slate, dimensional or luxury asphalt shingles to mimic the look of wood or slate)
Rake and Eave	Wood, composite wood
Cornice	Wood, composite wood
Brackets	Wood, composite wood, fiberglass
Gutter	Half-round copper, metal
<b>Windows, Bay Windows, and Entry Doors</b>	
Trim or Surround	Wood, composite wood, fiber cement
Entry Door	Wood, composite wood, aluminum-clad wood, fiberglass
Window Frames	Wood, aluminum-clad wood
Glazing	Clear glass; shall not be tinted, mirrored, or colored
<b>Garages</b>	
Garage Door <sup>18</sup>	Wood, composite wood, fiberglass
<b>Balconies</b>	
Post, Handrail, Fascia, and Support Members	Wood, composite wood, solid metal
Railing	Wood, composite wood, metal
<b>Porches</b>	
Columns	Wood, composite wood, metal, fiberglass
Railing	Composite wood, wood, solid metal
<b>Storefronts</b>	
Storefront Module	Wood, composite wood, metal
Storefront Base (Bulkhead)	Wood, stucco, brick, fiber cement

Q.2. Materials: Cottage (Continued)	
Element	Allowed Materials
<b>Chimneys</b>	
Cap	Copper, steel
Body	Brick, stone, cast stone (including veneers of any of the above)
<b>Exterior Building Lighting</b>	
Body and Mount	Wrought iron, metal
Shield	Clear, translucent, punched, louvers
<b>Stairs and Ramps</b>	
Treads and Risers	Wood, composite wood, stucco, brick, stone
Handrails	Wood, composite wood, stucco, stone, wrought iron, metal
<b>Trellises and Carports</b>	
Spanning Members	Wood, composite wood
Trellis Posts	Wood, composite wood
Carport Support Posts	Wood, composite wood, stucco
<b>Trash Enclosure</b>	
Walls	Wood, composite wood, stucco
<b>Fences and Hedges</b>	
Walls	Stucco, brick, stone (faux manufactured stone veneer is prohibited), concrete block (coated and painted or pigmented to match the main building)
Fences <sup>19</sup>	Wood, composite wood, wrought iron, metal, chain link (vinyl-coated black or green)

<sup>18</sup> Metal roll up doors are allowed only if not publicly visible. Metal security grilles (including roll up function) are allowed for parking structures.

<sup>19</sup> Publicly visible fences may not be chain link unless screened with vines.

## 25.06.050 Mediterranean Style Group



### A. General Description

#### Spanish Colonial Revival Sub-Style

The Spanish Colonial Revival style is a reflection of Santa Barbara's Spanish architectural tradition. The sub-style adheres to simple building massing, the impression of traditional masonry construction, prominence of clay tile roof forms, and craftsmanship with an emphasis on raw materials.

#### Italian Mediterranean Sub-Style

While similar to the Spanish Colonial Revival style in terms of cladding and materials, the Italian Mediterranean style is expressed through the symmetrical and formal composition of openings, the cornice detailing at rakes and eaves, and the types of columns and pilasters used.



**B.1. Character Description: Spanish Colonial Revival**

- Flat roofs or low-pitched gabled and/or hipped roofs, often stepped and with simple eave and cornice details
- Red cap-and-pan, terra-cotta clay roof tile installed with a scattered field pattern, random mortar lifts, and selectively placed booster tile
- Flat, rectilinear wall plane with symmetrical or asymmetrical compositions of vertically proportioned punched openings without trim
- Stucco as primary façade material with stucco or wood attached elements, and decorative tile at surrounds/stairs
- Architectural details and materials display influence of Spanish and Moorish architecture
- Ornamental elements, such as chimneys, vents, and gutters

**B.2. Character Description: Italian Mediterranean**

- Low-pitched hipped roofs clad in red tile with boxed eaves, often bracketed
- Flat, rectilinear wall plane with vertically proportioned punched openings without trim
- Stucco as primary façade material with stucco, wood, or metal attached elements
- Formal and/or symmetrical composition of doors and windows
- Use of classical orders, including columns and pilasters, to accentuate entrances and openings

# Elements of Spanish Colonial Revival Style

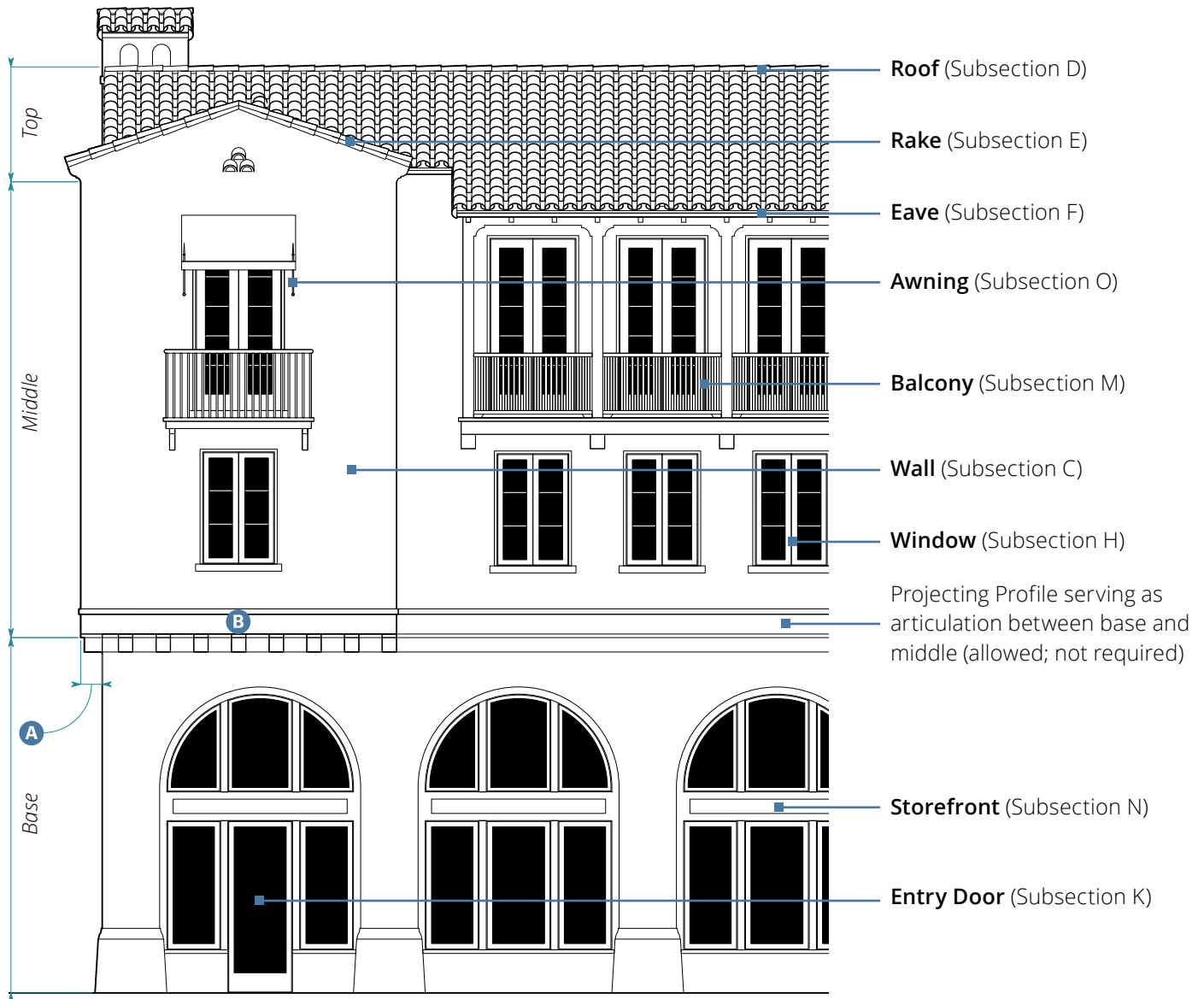

Example Building Elevation: Spanish Colonial Revival

## C. Wall: All

### Base

Base is not required for this style group.

## C. Wall: All (Continued)

### Wall Projections

Wall projections are allowed, but not required.

Depth 1'-0" min. A

Provide lintel for full width of projection. B



# Elements of Italian Mediterranean Style



Example Building Elevation: Italian Mediterranean

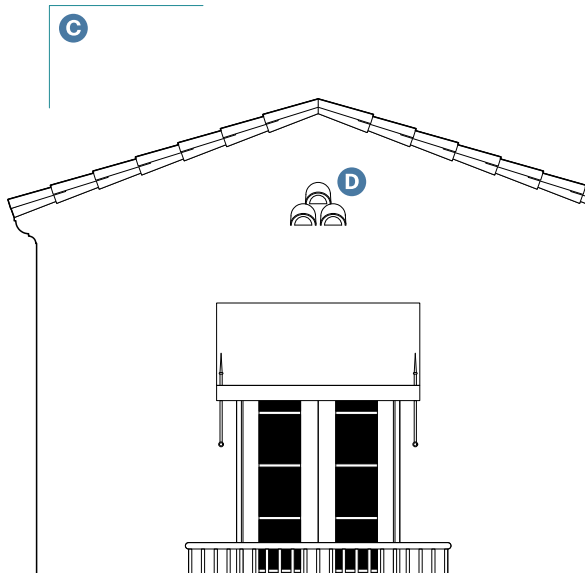

Gable End Elevation

D. Building Roof: All		
Standards	Sloped Roof	Flat Roof
<b>Roof Form</b>		
Type	Gable, Hip, Shed <sup>1</sup>	Flat <sup>2,3</sup>
Pitch	3:12 min.; 6:12 max.	N/A
<b>Applicable Subsections</b>		
E. Rake	Applies	N/A
F. Eave	Applies	N/A
G. Parapet	N/A	Applies
<b>Roof Tile Installation Standards</b>		
Starter course shall be double tiled, min.		
Unpigmented mortar required at birdstops, hips, and ridges.		
<b>Attic Vents</b>		
Placement	Centered within gable	

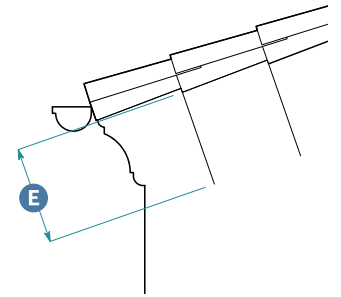

Rake Elevation (with Ornamental Scored Scallop Pattern)

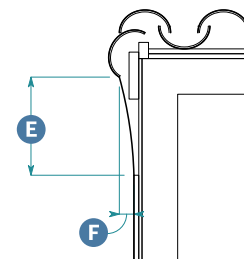

Rake Section (with Ornamental Scored Scallop Pattern)

D. Building Roof: All (Continued)		
<sup>1</sup> High side of shed roof must terminate into wall.		
<sup>2</sup> Flat roof parapets that are publicly visible cannot exceed 25% of the building length, or 25' max., whichever is greater.		
<sup>3</sup> In the El Pueblo Viejo Landmark District, flat roof parapets cannot be publicly visible.		
E. Rake: All		
Allowed Ornament <sup>4</sup>		
Height	1'-0" min.	E
Projection to Rake Tile	3" min.	F
<sup>4</sup> Scored scallop pattern shall align with tile breaks, where occurs.		

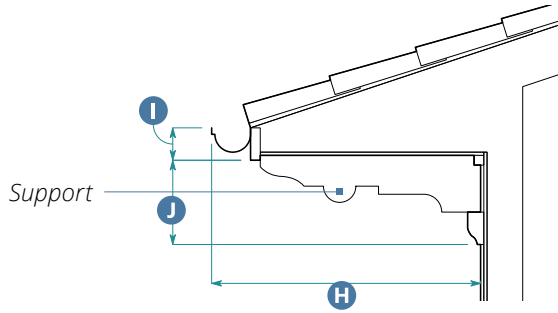

Returned Eave Section: Italian Mediterranean

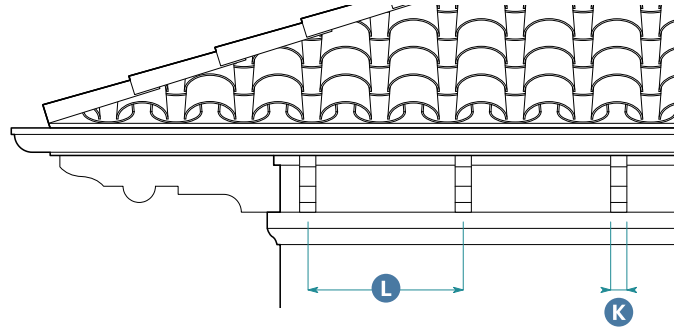

Returned Eave Elevation: Italian Mediterranean

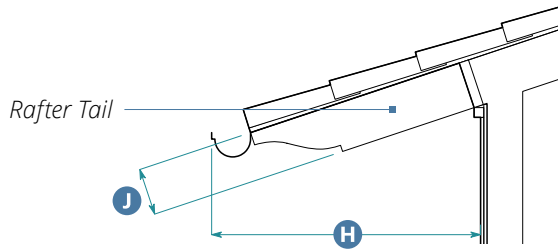

Open Eave Section: Italian Mediterranean

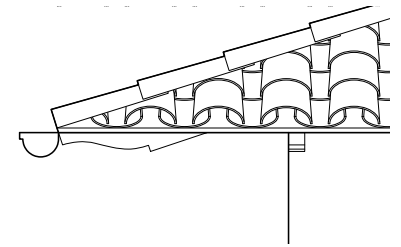

Open Eave Elevation: Italian Mediterranean

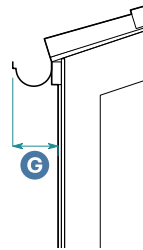

Closed Eave Section: Spanish Colonial Revival

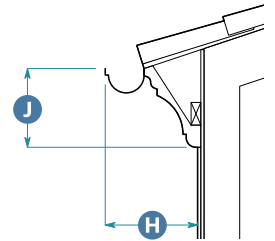

Closed Eave Section: Italian Mediterranean

F.1. Eave: Spanish Colonial Revival			
Standards	Closed	Open	Returned
<b>Horizontal Projection<sup>5</sup></b>			
Overall	3" min.	N/A	N/A

<sup>5</sup>Horizontal projection includes gutter.

F.2. Eave: Italian Mediterranean			
Standards	Closed	Open	Returned
<b>Horizontal Projection<sup>6</sup></b>			
Overall	1'-0" min.	3'-0" min.	2'-6" min.

<b>Fascia/Cornice Molding</b>			
Height	1'-0" min.	N/A	6" min.

<b>Allowed Rafter Tails and Supports</b>			
Type	N/A	Shaped, Plumb Cut	Shaped
Height	N/A	8" min.	1'-0" min.
Width	N/A	3" min.	3" min.
Spacing	N/A	2'-0" max. on center	2'-0" max. on center
Placement	N/A	Below decking	Below fascia

<sup>6</sup>Horizontal projection includes gutter.

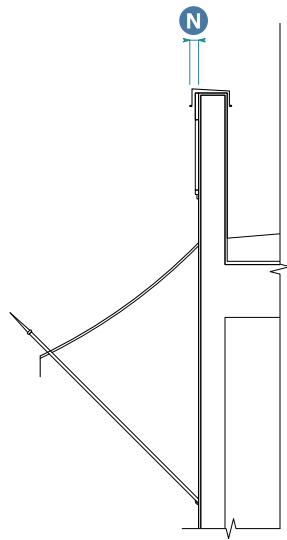

Parapet Section: Spanish Colonial Revival

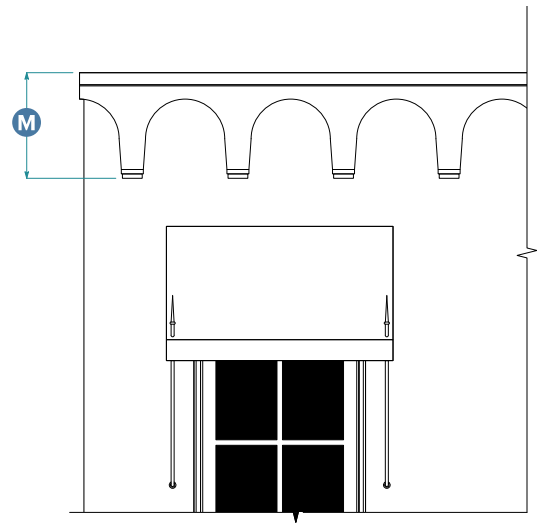

Parapet Elevation: Spanish Colonial Revival

**G. Parapet: All**

**Allowed Ornament**

Type	Wall Moulding at Top of Parapet	
Height	2'-0" max.	M
Projection	1'-0" max.	N
Placement	Continuous with Parapet Cap	

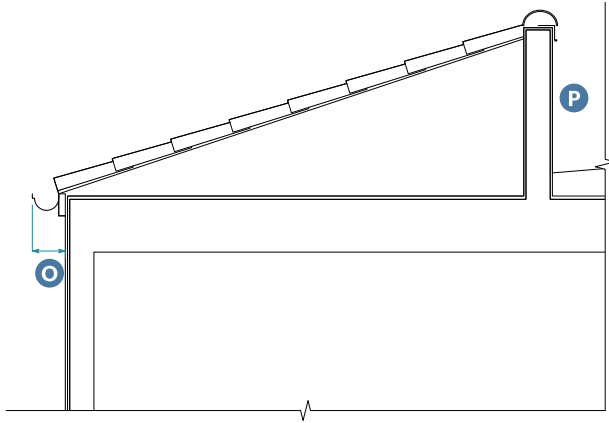

Sloped Roof Parapet Section: Spanish Colonial Revival

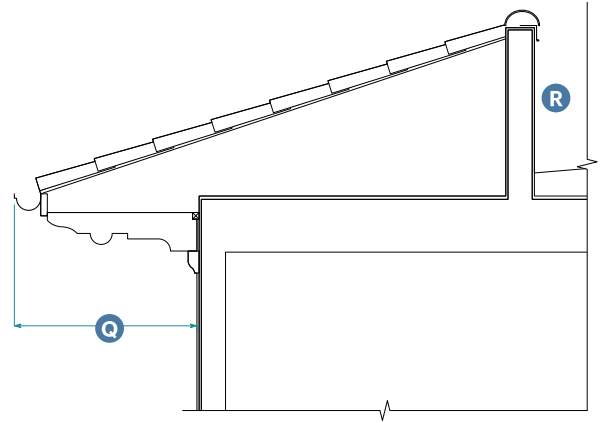

Sloped Roof Parapet Section: Italian Mediterranean

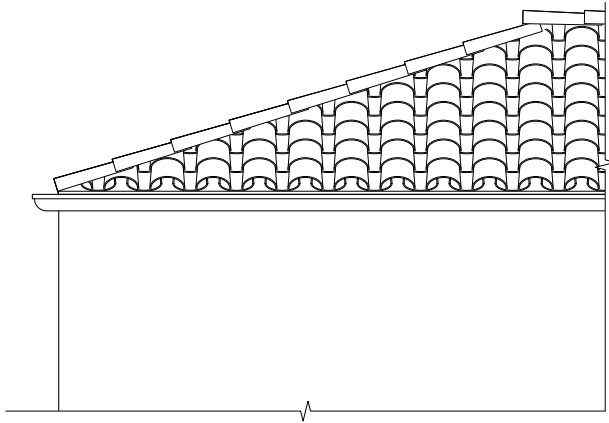

Sloped Roof Parapet Elevation: Spanish Colonial Revival

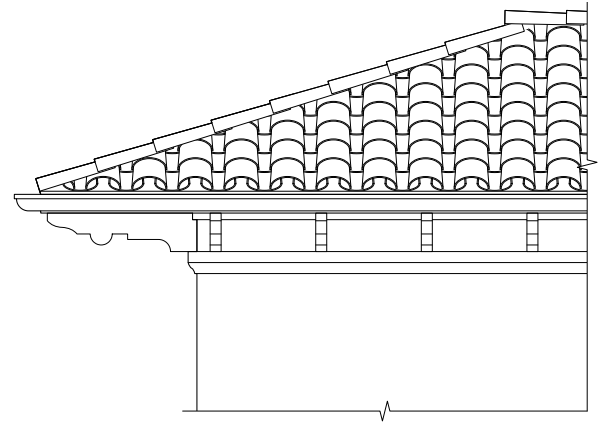

Sloped Roof Parapet Elevation: Italian Mediterranean

**G.1. Parapet: Spanish Colonial Revival**

**Sloped Roof with Parapet**

Eave Projection See Subsection F.1 (Eave) for eave standards. O

Parapet Height 2'-6" min. P

Sloped roof shall extend to reach full height of parapet.

Sloped roof portion shall comply with all standards applicable to sloped roofs in Subsection D (Building Roof).

**G.2. Parapet: Italian Mediterranean**

**Sloped Roof with Parapet**

Eave Projection, See Subsection F.2 (Eave) for eave standards. Q

Profile, and Supports R

Parapet Height 2'-6" min. R

Sloped roof shall extend to reach full height of parapet.

Sloped roof portion shall comply with all standards applicable to sloped roofs in Subsection D (Building Roof).

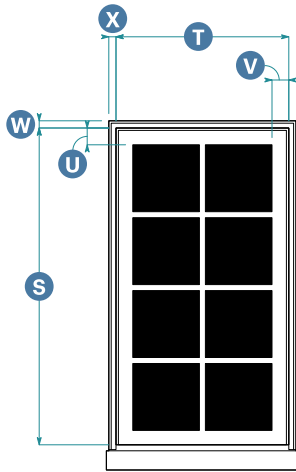

Typical Window Elevation with 8 Parts Glazing Divisions:  
Spanish Colonial Revival

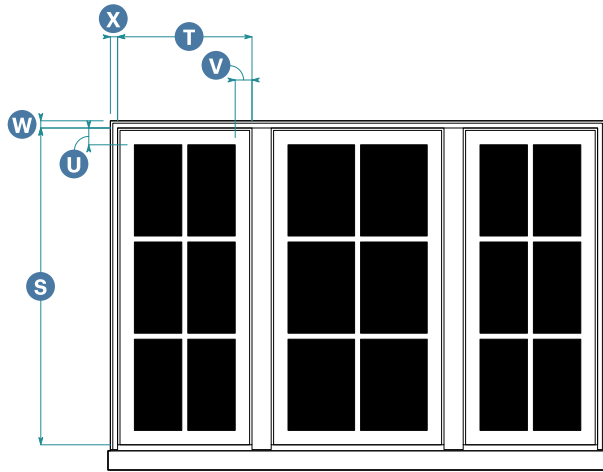

Ganged Window Elevation with 6 Parts Glazing Divisions:  
Italian Mediterranean

**H. Windows: All**

**Opening Proportion, Height **S** to Width **T****

Typical Window	
Ground Floor	2:1 min.
Typical Upper Floor	7:4 min.
Accent Window	
Rectangle	3:2 min. (2'-6" max. width)
Square	1:1 min. (3'-0" max. width)
Ganged Window	3:5 min.
Picture Window	6:5 min.
Dormer Window	7:4 min.

**Opening**

Shape	Rectangular, Arched
-------	---------------------

**Window**

Operation	Casement, Fixed
Glazing Divisions <sup>7</sup>	6 or 8 parts

Width of lites shall be no greater than their height.

**Sash Widths**

Rail	2" min.	<b>U</b>
Stile	2" min.	<b>V</b>

**Moulding Widths**

Head	2" min.	<b>W</b>
Jamb	2" min.	<b>X</b>
Apron	None	

**Window Frame Recess**

Depth	2" min. from face of surround to face of sash.
-------	--

**H. Windows: All (Continued)**

**Sill Projection**

Depth	2" min. from face of surround.
-------	--------------------------------

**Pediment**

Allowed	Italian Mediterranean only
---------	----------------------------

**Mullions**

Mullions required between ganged windows.

**Placement**

No portion of window shall be allowed within 1'-6" of outside corners of building.

<sup>7</sup>Glazing divisions for picture and accent windows may be one part. Italian Mediterranean may also have 10, 12, or 15 equal parts.



Bay Window Plan

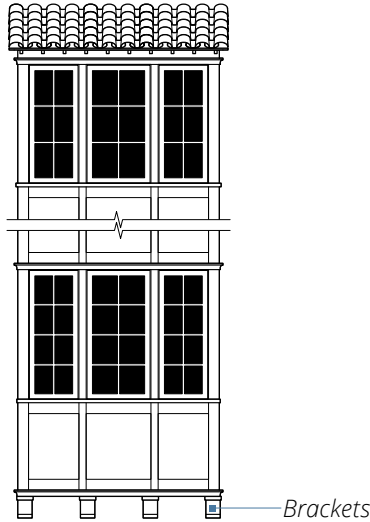

Bay Window Elevation

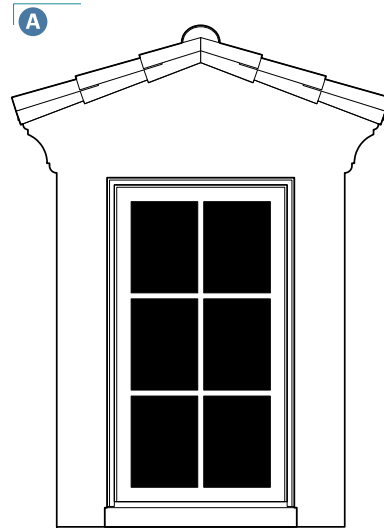

Dormer Elevation with Gable Roof

I. Bay Windows: All	
<b>Form</b>	
Type	Square
Continuous horizontal articulation on building shall wrap bay window form.	
<b>Dimensions</b>	
Width	6'-0" min.; 12'-0" max. <span style="float: right;">Y</span>
Depth	1'-0" min.; 4'-0" max. <span style="float: right;">Z</span>
<b>Height</b>	
Bay window may extend from second story to top story.	
Bay window may occupy first story on buildings less than 3 stories tall.	
Bay window that does not extend to grade shall be supported on brackets.	
Bay window form shall be vertically continuous from lowest bay window to highest bay window.	
<b>Allowed Cornice Treatments</b>	
Building parapet wraps bay window.	
Bay window stops below building eave (provide roof or cornice for bay window).	
Bay window terminates into building eave (bay window shall not project vertically or horizontally beyond building eave).	

J. Dormers: All	
<b>Roof Form</b>	
Type	Gable
Pitch	3:12 min.; 6:12 max. <span style="float: right;">A</span>
<b>Horizontal Projection</b>	
Rake	See Subsection E (Rake) for rake standards.
Eave	See Subsection F (Eave) for eave standards.
<b>Placement</b>	
Setback from Side Façade	3'-0" min.
Setback from Façade to	1'-0" min.
Face of Dormer	Dormers shall not interrupt continuity of main building roof eave.
<b>Window</b>	
See Subsection H (Windows) for window standards.	

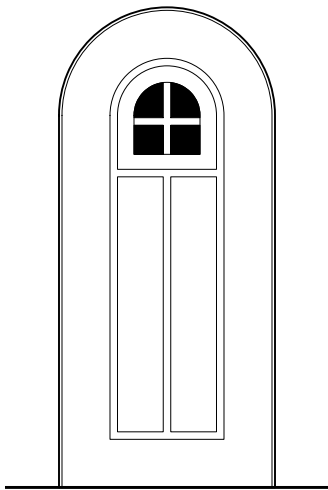

*Vision Glass Door Elevation with Two Panels and Arched Span*

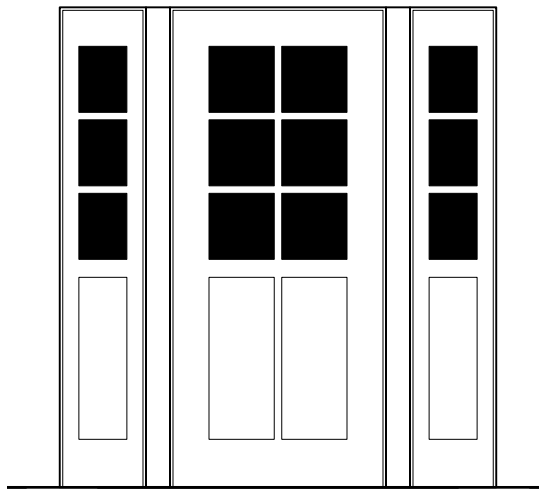

*Half Glass Door Elevation with Two Panels and Sidelights*

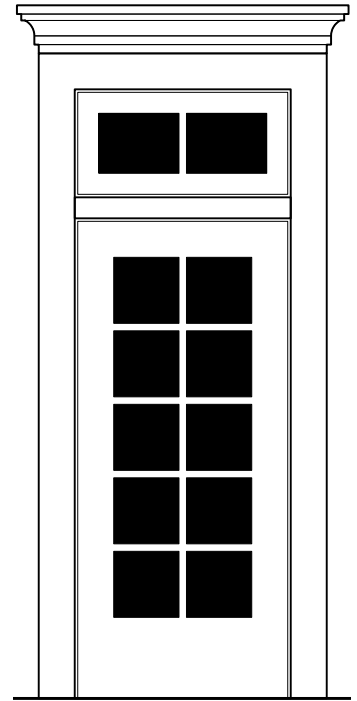

*Full Glass Door Elevation with Transom and Entablature: Italian Mediterranean*

**K. Entry Doors: All**

**Door**

Number of Panels	2 min. <sup>8</sup>
Frame Recess	4" min. from face of door to face of surround.

**Lite Types/Glazing Divisions**

Vision Glass	0 parts min.; 4 parts max.
Half Glass	6 parts
Full Glass	8 parts min.; 15 parts max.

**Surround**

Span Type	Square, Arch
-----------	--------------

**Glazed Openings**

Transom	Allowed
Sidelights	Allowed
Entablature	Italian Mediterranean only
Pediment	Italian Mediterranean only

**Placement**

No portion of door shall be allowed within 1'-6" of outside corners of building.

Doors shall be centered along width of balconies and arches, where occurs.

<sup>8</sup> Panels not required for full glass lite type.



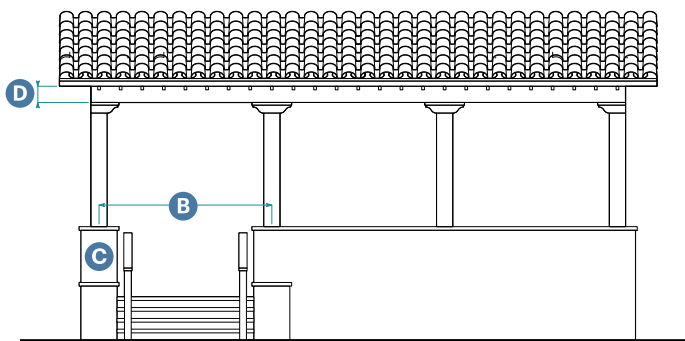

One-Story Porch with Square Column and Capital Connection:  
Spanish Colonial Revival

**L.1. Columns/Pilasters: Spanish Colonial Revival**

**Columns + Pilasters**

Shape	Square, Round
Width/Diameter	8" min. each
Spacing	9'-0" max. on center <b>B</b>
Pedestal Height <sup>9</sup>	3'-0" min. <b>C</b>
Entablature/Beam Connection	Capital, Bracket, Corbel

Columns must not span multiple stories.

**Additional Features**

Paneling	Allowed
Fluting	Not Allowed

**Entablature Height**

Topmost Floor	1'-6" min. <b>D</b>
Intermediate Floor	10" min.

**Guard/Railing**

Allowed Types	Square, Turned (includes balustrade), Wall
Width Between Posts	3'-0" min. on center

<sup>9</sup> Pedestal may be omitted.

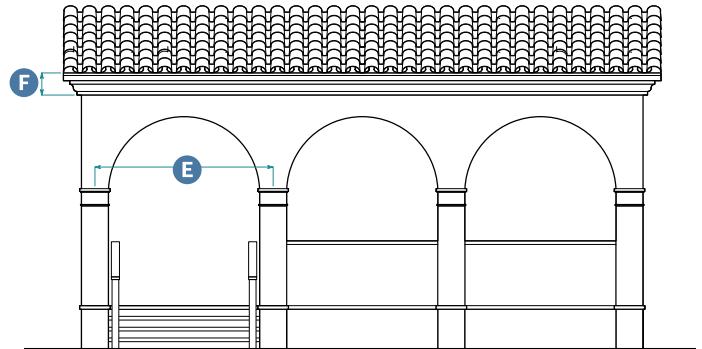

One-Story Porch with Round Column and Capital Connection:  
Italian Mediterranean

**L.2. Columns/Pilasters: Italian Mediterranean**

**Columns + Pilasters**

Shape	Square, Round, Tuscan (Tapered)
Width/Diameter	8" min. each
Spacing	9'-0" max. on center <b>E</b>
Pedestal Height <sup>10</sup>	3'-0" min.
Entablature/Beam Connection	Capital

Columns must not span multiple stories.

**Additional Features**

Paneling	Allowed
Fluting	Not Allowed

**Entablature Height**

Topmost Floor	1'-6" min. <b>F</b>
Intermediate Floor	10" min.

**Guard/Railing**

Allowed Types	Square, Turned (includes balustrade), Wall
Width Between Posts	3'-0" min. on center

<sup>10</sup> Pedestal may be omitted.

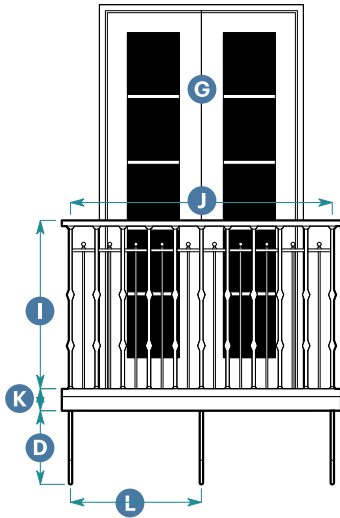

Juliet Balcony with Decorative Metal Railing, Front Elevation

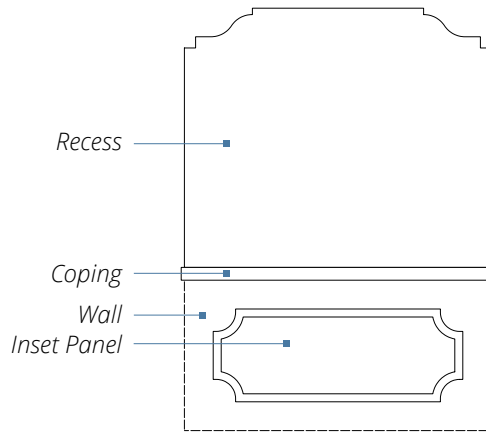

Recessed Balcony with Stucco Wall, Front Elevation

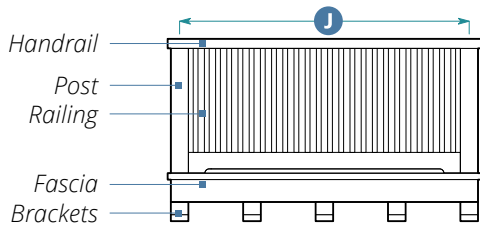

Balcony with Square Railing, Front Elevation

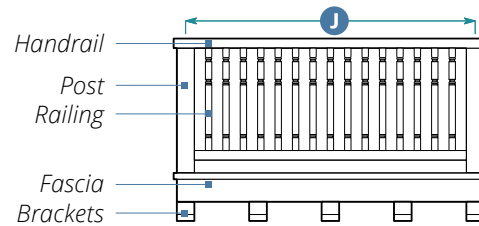

Balcony with Turned Railing, Front Elevation

**M. Balconies: All**

**Allowed Types**

**Type 1 - Juliet Balcony**

Inward-swinging door with full glazing required	<b>G</b>
Base Height	3" min. <b>H</b>
Base Projection	4" min.; 2'-0" max.

**Type 2 - Occupiable Balcony**

Clear Depth	6'-0" min.
Area	48 sq. ft. min.
Recess into Façade	6'-8" max.
Overall Width	10'-0" max.

**M. Balconies: All (Continued)**

**Guard/Railing**

Allowed Types	Square, Turned (includes balustrade), Wall <sup>11</sup>
Height	Per Building Code <b>I</b>
Width Between Posts	3'-0" min. on center <b>J</b>

**Brackets/Supports**

Allowed Types	Brackets, Cantilevered Beams
Depth	80% of projection depth at bracket, min.
Height	50% of bracket depth, min. <b>K</b>
Spacing	4'-0" on center, max. <b>L</b>

<sup>11</sup> Wall is allowed only for recessed balconies and shall not be used for Juliet Balcony.

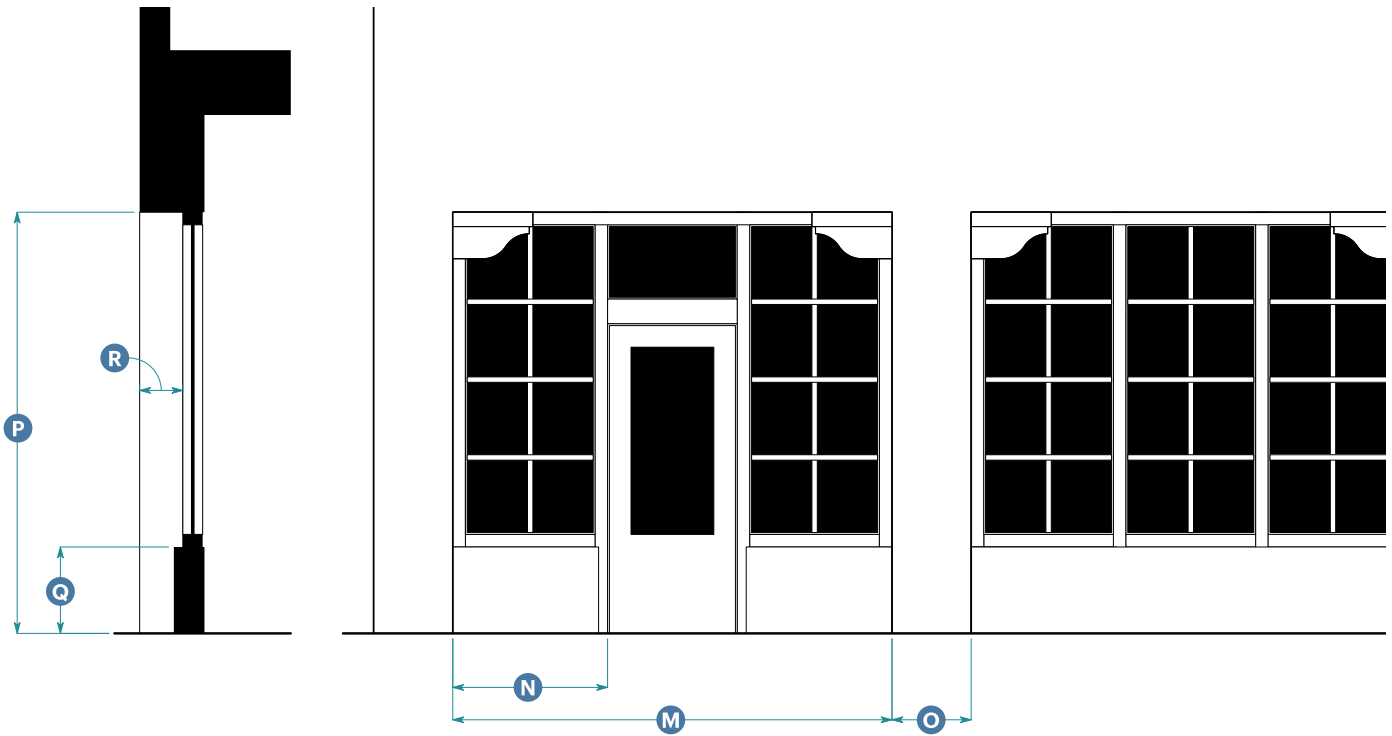

Storefront Section

Storefront Elevation

**N. Storefronts: All**

**Width**

Storefront Module <sup>12</sup>	10'-0" min.; 25'-0" max.	<b>M</b>
Display Window	3'-0" min.; 6'-0" max.	<b>N</b>
Distance Between Storefront Modules	1'-6" min.; 6'-0" max.	<b>O</b>

**Height**

Overall	None	
Head Height	10'-0" min.	<b>P</b>
Cornice	None	
Signage Band	None	
Bulkhead	1'-0" min.; 2'-0" max.	<b>Q</b>

**Horizontal Recess**

Depth	1'-0" min.; 2'-0" max. <sup>13</sup>	<b>R</b>
-------	--------------------------------------	----------

Bulkhead shall be continuous, unless divided by pilaster, and align with base height of building (if any).

For arched storefronts, see Section 25.05.130 (Arcades).

<sup>12</sup> May be expressed with pilasters. See Subsection L (Columns/Pilasters)

<sup>13</sup> No max. depth for residential entries.

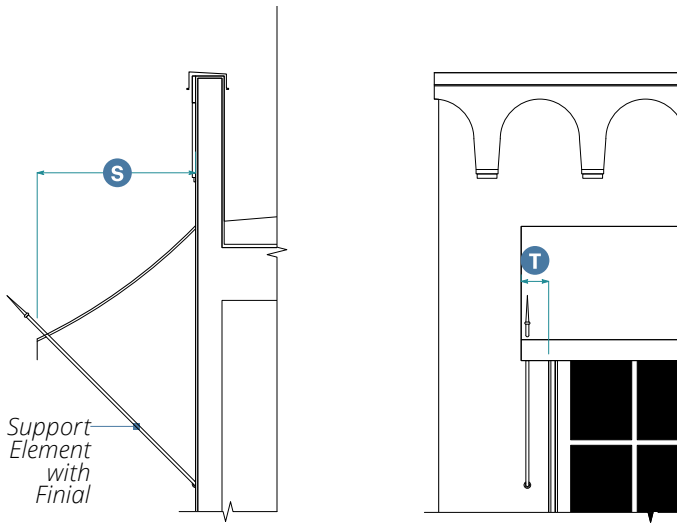

Awning Section

Awning Elevation with Straight Valance

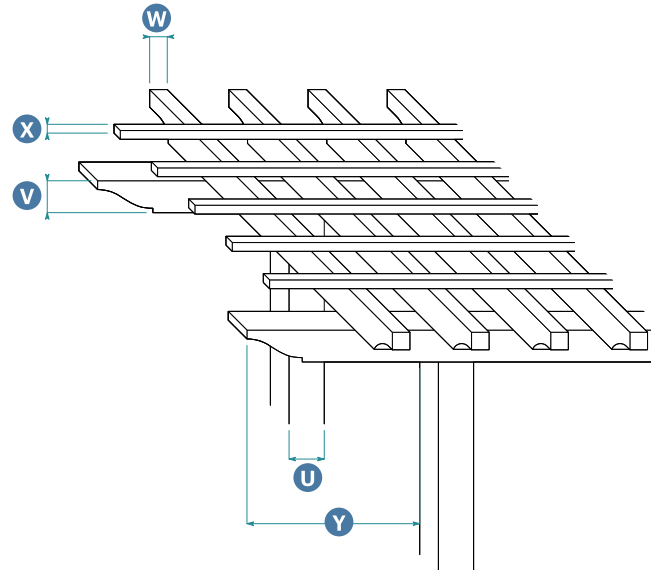

Trellis Diagram

O. Awning: All		
Awning Design		
Horizontal Projection	3'-0" min.	S
Offset from Opening	6" max.	T
Surface Shape <sup>14</sup>	Angled Surface with Open Sides	
Valance Shape	Straight	
Required Support Elements	Finials <sup>15</sup>	

The bottom edge of the valance shall fall below the window or door head height, unless this conflicts with minimum clear height standards.

Supports shall not be installed horizontally, and shall angle up from the point of wall attachment at an angle equal to the slope of the awning surface.

<sup>14</sup>Horizontally segmented, curved, and domed awnings are prohibited, except that curved awnings are allowed for an arched opening if placed within the arch such that the form and depth of the arch are still visible.

<sup>15</sup> Finials must be spear points in the Spanish Colonial Revival sub-style.

P. Trellises and Carports: All		
Dimensions		
Post	8" x 8" min.	U
Main and Cross Beam	4" x 8" min. <sup>16</sup>	V
Rafter	2" x 4" min.	W
Purlin or Lattice	2" x 2" min.	X
Overhang		
Beams	3'-0" max.	Y
Purlin or Lattice	2'-0" max.	
Trellis	1'-6" max.	

<sup>16</sup> Paired 2" x 8" members are allowed when placed on both sides of the supporting posts.

**Q.1. Materials and Colors: Spanish Colonial Revival**

Element	Allowed Materials
<b>Building Walls</b>	
Cladding	Stucco
Accent Materials	Stone, tile
Projection Materials	Wood, cast-stone
<b>Roof and Roof Elements</b>	
Roofing <sup>17</sup>	Two-piece (cap-and-pan) terra-cotta clay barrel tiles
Rake and Eave	Wood, composite wood, stucco
Cornice	Wood, composite wood, stucco
Brackets and Corbels	Wood, composite wood, stucco, fiberglass
Parapet Cap	Stucco, two-piece (cap-and-pan) terra-cotta clay barrel tiles
Finials	Metal (copper, cast iron, steel)
<b>Attic and Mechanical Vents</b>	
Vent	Masonry, terra-cotta clay barrel tiles, wood louvers, wrought iron grill
<b>Gutters, Downspouts, and Leaderheads</b>	
Gutter Profile	Half-round
Downspout Profile	Round
Materials	Copper <sup>18</sup> , metal
<b>Windows, Bay Windows, and Entry Doors</b>	
Entry Door	Wood, composite wood, aluminum-clad wood, fiberglass
Window Frames	Wood, aluminum-clad wood, steel
Door/Window Surrounds	Stucco, stone, cast stone, tile
Sill	Stucco, stone, cast stone
Glazing	Clear glass; shall not be tinted, mirrored, or colored
<b>Garages</b>	
Garage Door <sup>19</sup>	Wood, composite wood, fiberglass
<b>Balconies</b>	
Post, Handrail, Fascia, Railing, and Brackets	Wood, composite wood, wrought iron, metal <sup>20</sup>
Deck Soffit	Wood, composite wood, stucco, wrought iron, tile (glazed, terra-cotta), metal

**Q.1. Materials and Colors: Spanish Colonial Revival (Con't)**

Element	Allowed Materials
<b>Porches</b>	
Columns	Wood, composite wood, stucco fiberglass, metal
Railing	Wood, composite wood, wrought iron
<b>Storefronts</b>	
Storefront Module	Wood, composite wood, metal
Storefront Base (Bulkhead)	Stucco, tile
<b>Chimneys</b>	
Cap	Stucco, terra-cotta clay barrel tiles, copper, steel
Body	Stucco, brick, stone, cast stone (including veneers of any of the above)
<b>Exterior Building Lighting</b>	
Body and Mount	Wrought iron, metal
Shield	Clear, translucent, punched, louvers
<b>Stairs and Ramps</b>	
Treads and Risers	Wood, composite wood, stucco, brick, stone, tile, concrete <sup>20</sup>
Handrails	Wood, composite wood, stucco stone, wrought iron, metal
<b>Trellises and Carports</b>	
Spanning Members	Wood
Trellis Posts	Wood
Carport Support Posts	Wood, composite wood, stucco,
Connections	Steel, iron
<b>Trash Enclosure</b>	
Walls	Wood, composite wood, stucco
<b>Fences and Hedges</b>	
Walls	Stucco, stone (faux manufactured stone veneer is prohibited)
Fences <sup>21</sup>	Wood, composite wood, wrought iron, metal, chain link (vinyl-coated black or green)
Stucco wall finish shall be smooth trowel, with 1/2" to 3/4" bull-nosed corners.	
Accent tile shall be 6" x 6" minimum.	

**Q.1. Materials and Colors: Spanish Colonial Revival (Con't)**

Element	Allowed Materials
---------	-------------------

Where used, "metal" and "wrought iron" shall be solid metal (not hollow tube).

<sup>17</sup> Applies to pitched roof forms; visible birdstops not allowed.

<sup>18</sup> Required on façades facing rights-of-way and community open spaces.

<sup>19</sup> Metal roll up doors are allowed only if not publicly visible. Metal security grilles are allowed for parking structures.

<sup>20</sup> Allowed on façades not facing streets and community open spaces.

<sup>21</sup> Chain link fences are prohibited within the El Pueblo Viejo Landmark District. In other locations, publicly visible chain link fences are prohibited unless screened with vines.

**Q.2. Materials and Colors: Italian Mediterranean**

Element	Allowed Materials
---------	-------------------

**Wall**

Cladding	Stucco
----------	--------

Accent Materials	Tile, stone
------------------	-------------

**Roof and Roof Elements**

Roofing <sup>22</sup>	Two-piece (cap-and-pan) terra-cotta clay barrel tiles
-----------------------	---

Rake and Eave	Wood, composite wood, stucco
---------------	------------------------------

Cornice	Wood, composite wood, stucco, cast stone, fiberglass
---------	--

Brackets and Corbels	Wood, composite wood, stucco, fiberglass
----------------------	--

Parapet Cap	Stucco, two-piece (cap-and-pan) terra-cotta clay barrel tiles
-------------	---

Finials	Metal (copper, cast iron, steel)
---------	----------------------------------

**Attic and Mechanical Vents**

Vent	Masonry, terra-cotta clay barrel tiles, wood louvers, wrought iron grill
------	--

**Gutters, Downspouts, and Leaderheads**

Gutter Profile	Half-round
----------------	------------

Downspout Profile	Round
-------------------	-------

Materials	Copper <sup>23</sup> , metal
-----------	------------------------------

**Windows, Bay Windows, and Entry Doors**

Entry Door	Wood, composite wood aluminum-clad wood, steel, fiberglass
------------	--

Window Frames	Wood, aluminum-clad wood, steel
---------------	---------------------------------

Door/Window Surrounds	Stucco, stone, cast stone, tile
-----------------------	---------------------------------

Sill	Stucco, stone, cast stone
------	---------------------------

Glazing	Clear glass; shall not be tinted, mirrored, or colored
---------	--

**Garages**

Garage Door <sup>24</sup>	Wood, composite wood, fiberglass
---------------------------	----------------------------------

**Balconies**

Post, Handrail, Fascia, Railing, and Brackets	Wood, composite wood, cast stone, wrought iron, metal, fiberglass
---	---

Q.2. Materials and Colors: Italian Mediterranean (Con't)	
Element	Allowed Materials
Deck Soffit	Wood, composite wood, stucco, tile (glazed, terra-cotta), wrought iron, metal
<b>Porches</b>	
Columns	Wood, composite wood, stucco, cast stone, metal, fiberglass
Railing	Wood, composite wood, cast stone, wrought iron, fiberglass
<b>Storefronts</b>	
Storefront Module	Wood, composite wood, metal
Storefront Base (Bulkhead)	Stucco, tile
<b>Chimneys</b>	
Cap	Stucco, terra-cotta clay barrel tiles, copper, steel
Body	Stucco, brick, stone, cast stone (including veneers of any of the above)
<b>Exterior Building Lighting</b>	
Body and Mount	Wrought iron, metal
Shield	Clear, translucent, punched, louvers
<b>Stairs and Ramps</b>	
Treads and Risers	Stucco, brick, stone, tile, concrete <sup>25</sup>
Handrails	Wood, composite wood, stucco, stone, wrought iron, metal
<b>Trellises and Carports</b>	
Spanning Members	Wood
Trellis Posts	Wood
Carport Support Posts	Wood, composite wood, stucco,
Connections	Steel, iron
<b>Trash Enclosure</b>	
Walls	Wood, composite wood, stucco
<b>Fences and Hedges</b>	
Walls	Stucco, stone (faux manufactured stone veneer is prohibited)
Fences <sup>26</sup>	Wood, composite wood, wrought iron, metal, chain link (vinyl-coated black or green)

Q.2. Materials and Colors: Italian Mediterranean (Con't)	
Element	Allowed Materials
Stucco wall finish shall be smooth trowel, with 1/2" to 3/4" bull-nosed corners.	
Accent tile shall be 6" x 6" minimum.	
Where used, "metal" and "wrought iron" shall be solid metal (not hollow tube).	
<sup>22</sup> Applies to pitched roof forms; visible birdstops not allowed.	
<sup>23</sup> Required on façades facing streets and community open spaces.	
<sup>24</sup> Metal roll up doors are allowed only if not publicly visible. Metal security grilles (including roll up function) are allowed for parking structures.	
<sup>25</sup> Allowed on façades not facing streets and community open spaces.	
<sup>26</sup> Chain link fences are prohibited within the El Pueblo Viejo Landmark District. In other locations, publicly visible chain link fences are prohibited unless screened with vines.	



#### A. General Description

##### **Contemporary Sub-Style**

Contemporary style buildings have a sleek aesthetic and minimal ornamentation. This style focuses on combining simple rectilinear massing forms with changes in material and color. The use of glass and cantilevered elements imbues buildings with a sense of lightness and simplicity.

##### **Industrial Sub-Style**

The Industrial style similarly uses simple building forms, but utilizes gabled roof forms as well as flat roofs. Openings are simple and laid out in a rational manner. Thoughtful aging of industrial material, often metal, is allowed.





**B.1. Character Description: Contemporary**

- Simple rectilinear massing volumes
- Limited pushing and pulling of massing forms, delineated by changes in materials, colors, and finishes
- Limited ornamentation and simple punched openings
- Bay windows, awnings, balconies, and trellises used to break down façade and volume

**B.2. Character Description: Industrial**

- Low- and medium-pitched or flat roofs with shallow eave or parapet
- Simple gable roof forms
- Horizontally proportioned opening made from ganged vertical windows

# Elements of Contemporary Style

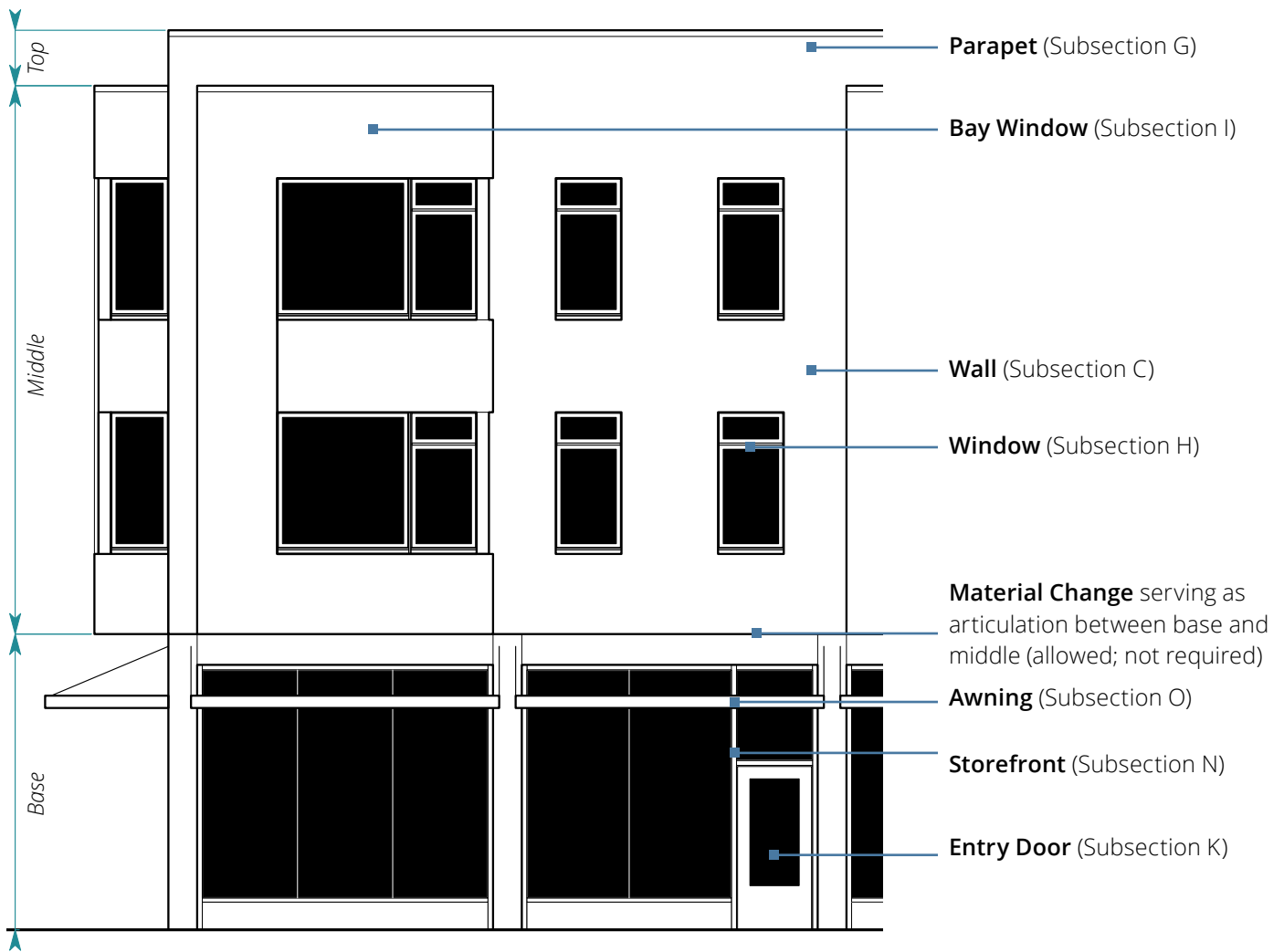

Example Building Elevation: Contemporary

## C.1. Wall: Contemporary

### Base

Base is not required for this sub-style.

### Middle and Top

Cantilever without 6'-0" max. projection  
visually supportive  
column

Material changes may only occur at convex corners both  
vertical and horizontal.

# Elements of Industrial Style



Example Building Elevation: Industrial

C.2. Wall: Industrial	
<b>Trim<sup>1</sup></b>	
Width	3" min. <b>A</b>
<sup>1</sup> Trim not required on buildings or portions of buildings where stucco or stone is the primary wall material.	
<b>Base</b>	
Height	1'-0" min.; 1/2 story max. <b>B</b>
Required Articulation	Change in finish material <b>C</b>
Base is required for this sub-style.	

C.2. Wall: Industrial (Continued)	
<b>Middle and Top</b>	
Cantilever without visually supportive column	6'-0" max. projection
Material changes may only occur at convex corners both vertical and horizontal.	



Shed Roof Elevation

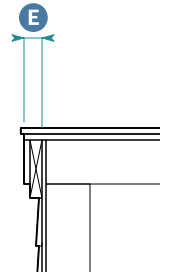

Flush Rake Section

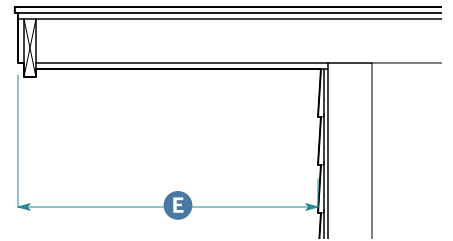

Projecting Rake Section

D. Building Roof: All		
Building Roof	Sloped Roof	Flat Roof
<b>Standards</b>		
<b>Roof Form</b>		
Type	Shed, Gable	Flat
Pitch	2:12 min.; 8:12 max.	N/A

Applicable Subsections		
E. Rake	Applies	N/A
F. Eave	Applies	N/A
G. Parapet	N/A	Applies

E.1. Rake: Contemporary		
Standards	Flush Profile	Projecting Profile
Horizontal Projection	No min.; 2" max.	2'-6" min.; 6'-0" max.

See Subsection F (Eave) for height standards.

E.2. Rake: Industrial		
Standards	Flush Profile	Projecting Profile
Horizontal Projection	No min.; 2" max.	6" min.; 1'-6" max.

See Subsection F (Eave) for height standards.

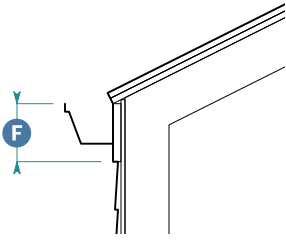

Closed Eave Section

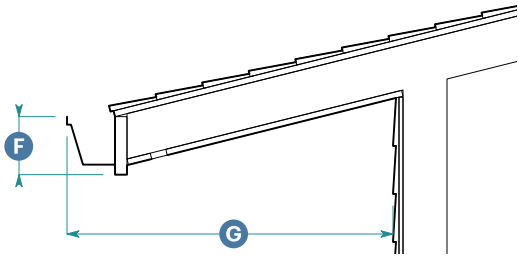

Open Eave Section

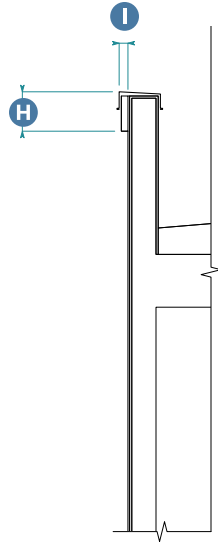

Parapet Section

F. Eave: All			
Standards	Open Eave	Closed Eave	
<b>Height</b>			
Fascia	6" min.	6" min.	F
<b>Horizontal Projection<sup>2</sup></b>			
Overall	1'-6" min.	N/A	G

<sup>2</sup>Horizontal projection includes gutter.

G.1. Parapet: Contemporary			
Parapet Cap/Molding			
Height	0" min.; 1'-0" max.		H
Horizontal Projection	0" min.; 3" max.		I

G.2. Parapet: Industrial			
Parapet Cap/Molding			
Height	0" min.; 6" max.		H
Horizontal Projection	0" min.; 3" max.		I

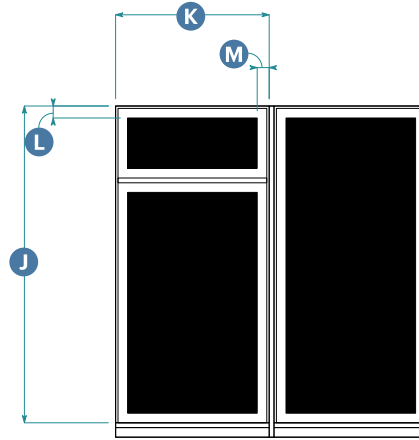
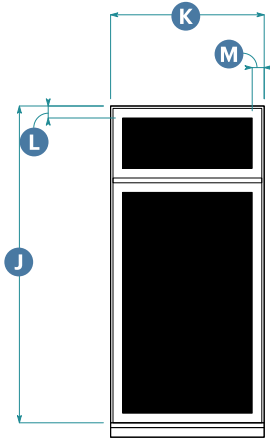

Typical Window Elevation: Contemporary

Ganged Window Elevation: Contemporary

**H.1. Windows: Contemporary**

**Opening Proportion, Height **J** to Width **K****

Typical Window	
Ground Floor	11:5 min.
Typical Upper Floor	2:1 min.
Accent Window	
Rectangle	3:2 min. (2'-6" max. width)
Square	1:1 min. (3'-0" max. width)
Ganged Window	3:5 min.
Picture Window	11:10 min.
Dormer Window	2:1 min.

**Opening**

Shape	Rectangular
-------	-------------

**Window**

Operation	Double-Hung, Single-Hung, Awning, Casement, Fixed
-----------	---

Glazing Divisions	None required
-------------------	---------------

Sash Widths

Rail	2" min.	<b>L</b>
Stile	2" min.	<b>M</b>

Trim Widths<sup>3</sup>

Head	2" min.
Jamb	2" min.
Apron	2" min.

**H.1. Windows: Contemporary (Continued)**

**Window Frame Recess**

Depth	2" min. from face of sash
-------	---------------------------

**Sill Projection**

Depth	2" min. from face of trim or surround
-------	---------------------------------------

**Pediment**

Allowed	No
---------	----

**Mullions**

Mullions required between ganged windows.

<sup>3</sup>Trim required for windows only on buildings or parts of buildings with lap siding.

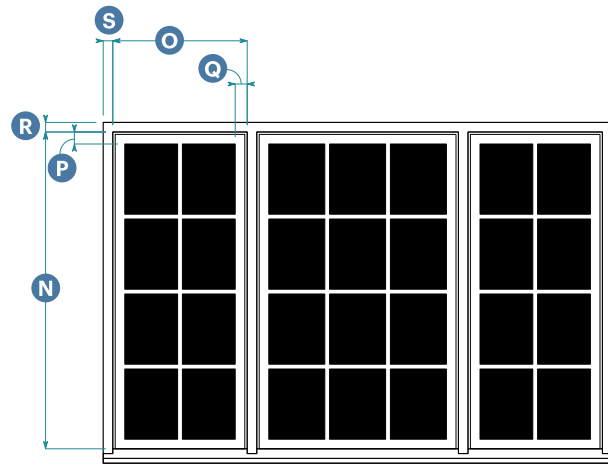
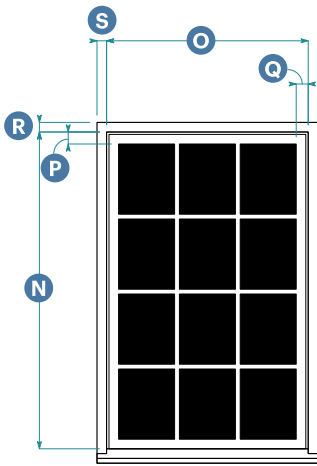

Typical Window Elevation with 12 Parts Glazing Division: Industrial

Ganged Window Elevation with 8 Parts and 12 Parts Glazing Divisions: Industrial

**H.2. Windows: Industrial**

**Opening Proportion, Height **N** to Width **O****

Typical Window	
Ground Floor	11:5 min.
Typical Upper Floor	2:1 min.
Accent Window	
Rectangle	3:2 min. (2'-6" max. width)
Square	1:1 min. (3'-0" max. width)
Ganged Window	3:5 min.
Picture Window	11:10 min.
Dormer Window	2:1 min.

**Opening**

Shape	Rectangular
-------	-------------

**Window**

Operation	Double-Hung, Single-Hung, Awning, Casement, Fixed
-----------	---

Glazing Divisions <sup>4</sup>	6 equal parts min.; 12 equal parts max.
--------------------------------	--

Sash Widths

Rail	2" min.	<b>P</b>
Stile	2" min.	<b>Q</b>

Trim Widths<sup>5</sup>

Head	2" min.	<b>R</b>
Jamb	2" min.	<b>S</b>
Apron	None	

**H.2. Windows: Industrial (Continued)**

**Window Frame Recess**

Depth	2" min. from face of sash
-------	---------------------------

**Sill Projection**

Depth	2" min. from face of trim or surround
-------	---------------------------------------

**Pediment**

Allowed	No
---------	----

**Mullions**

Mullions required between ganged windows.

<sup>4</sup>Glazing divisions for picture windows may be one part.

<sup>5</sup>Trim required for windows only on buildings or parts of buildings with lap siding.

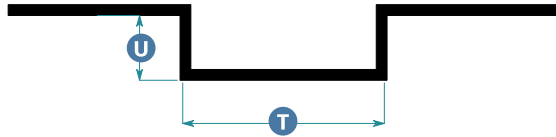

Bay Window Plan

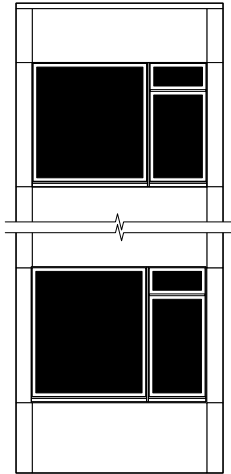

Bay Window Elevation

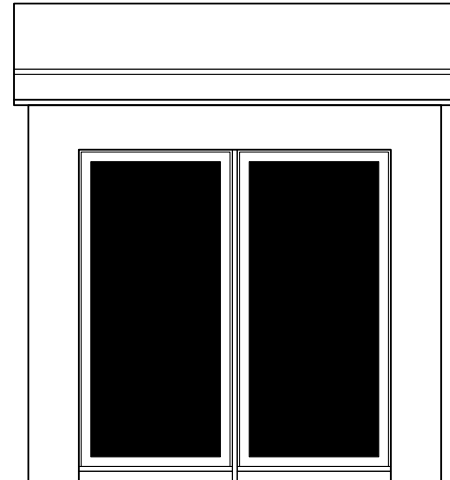

Dormer Elevation

I. Bay Windows: All	
<b>Form</b>	
Type	Square
<b>Dimensions</b>	
Width	6'-0" min.; 12'-0" max. <span style="float: right;">T</span>
Depth	8" min.; 4'-0" max. <span style="float: right;">U</span>
<b>Height Standards</b>	
Bay window may extend from second story to top story.	
Bay window may occupy first story on buildings less than 3 stories tall.	
Bay window form shall be vertically continuous from lowest bay window to highest bay window.	
<b>Allowed Cornice Treatments</b>	
Building parapet wraps bay window form.	
Bay window stops below building eave (provide roof or cornice for bay window).	
Bay window terminates into building eave (bay window form shall not project vertically or horizontally beyond building eave).	

J. Dormers: All	
<b>Roof Form</b>	
Type	Shed
Pitch	2:12 min.; 6:12 max.
<b>Horizontal Projection</b>	
Rake	See Subsection E (Rake) for rake standards.
Eave	See Subsection F (Eave) for eave standards.
<b>Placement</b>	
Setback from	1'-0" min.
Façade to Face of Dormer	
Dormers shall not interrupt continuity of main building roof eave.	
<b>Window</b>	
See Subsection H (Windows) for window standards.	



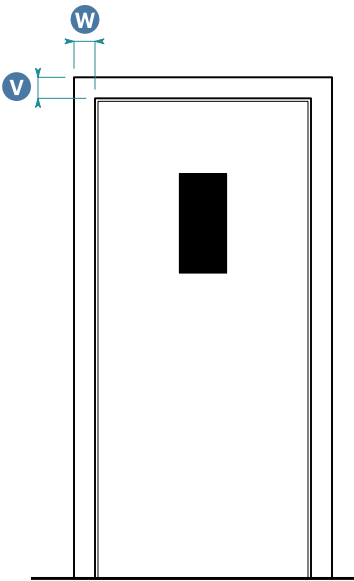

Vision Glass Door Elevation with Square Span

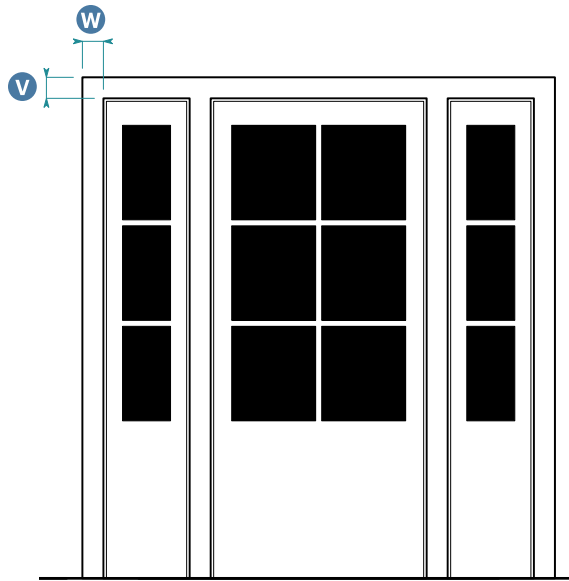

Half Glass Door Elevation with Sidelights

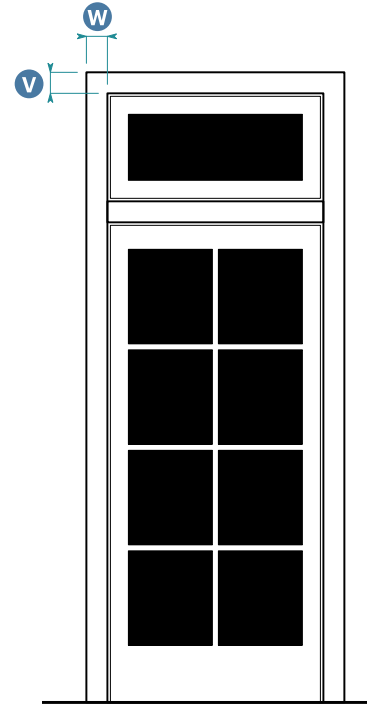

Full Glass Door Elevation with Transom

**K.1. Entry Doors: Contemporary**

**Door**

Number of Panels 0 min.

**Lite Types/Glazing Divisions**

Vision Glass 0 min.

Half Glass 0 min.

Full Glass 0 min.

**Surround**

Span Type Square

**Glazed Openings**

Transom Allowed

Sidelights Allowed

**K.2. Entry Doors: Industrial**

**Door**

Number of Panels 0 min.

**Lite Types/Glazing Divisions**

Vision Glass 0 parts min.; 4 parts max.

Half Glass 4 parts min.

Full Glass 8 parts min.

**Surround**

Span Type Square

Head Width 2" min. (V)

Jamb Width 2" min. (W)

**Glazed Openings**

Transom Allowed

Sidelights Allowed

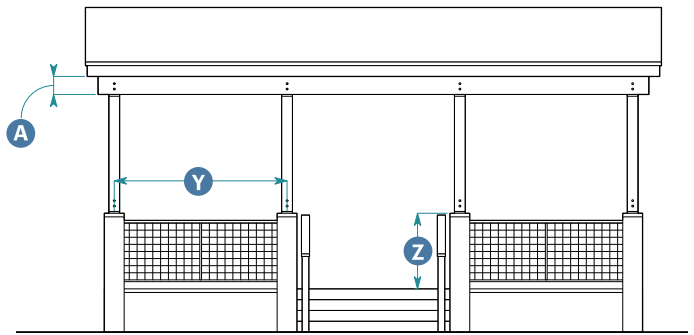
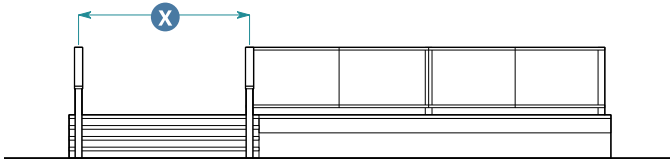

One-Story Porch: Contemporary

L.1. Columns/Pilasters: Contemporary	
Columns + Pilasters	
Shape	Square, Steel Section
Width/Diameter	6" min.; 4" min. for Steel Section
Spacing	8'-0" max. on center <span style="float: right;">X</span>
Pedestal Height <sup>6</sup>	3'-0" min.
Columns must not span multiple stories.	
Additional Features	
Paneling	Not Allowed
Fluting	Not Allowed

<sup>6</sup> Pedestal may be omitted.

One-Story Porch with Square Columns on Pedestals: Industrial

L.2. Columns/Pilasters: Industrial	
Columns + Pilasters	
Shape	Square, Steel Section
Width/Diameter	6" min.; 4" min. for Steel Section
Spacing	9'-6" min., 12'-0" max. on center <span style="float: right;">Y</span>
Pedestal Height <sup>7</sup>	3'-0" min. <span style="float: right;">Z</span>
Columns must not span multiple stories.	
Additional Features	
Paneling	Not Allowed
Fluting	Not Allowed
Entablature Height	
Topmost Floor	1'-6" min. <span style="float: right;">A</span>
Intermediate Floor	10" min.

<sup>7</sup> Pedestal may be omitted.

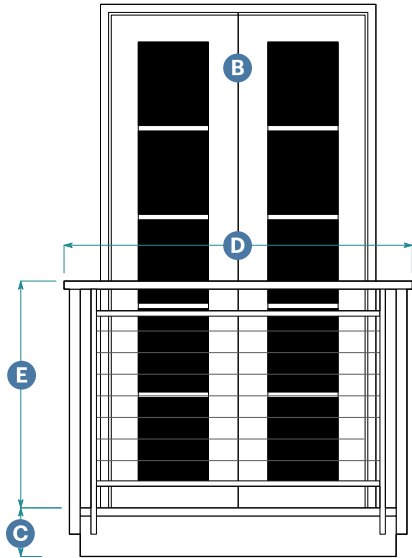

Juliet Balcony with Horizontal Railing, Front Elevation

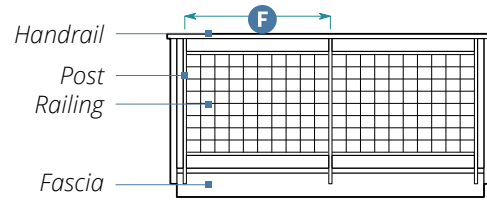

Balcony with Mesh Railing, Front Elevation

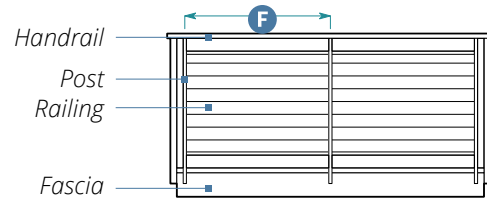

Balcony with Horizontal Railing, Front Elevation

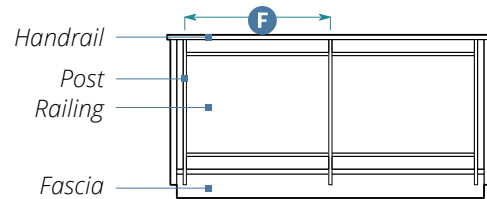

Balcony with Panel Railing, Front Elevation

**M. Balconies: All**

**Allowed Types**

**Type 1 - Juliet Balcony**

Inward-swinging door with full glazing required	(B)
Base Height	3" min. (C)
Base Projection	4" min.; 2'-0" max.

**Type 2 - Occupiable Balcony**

Clear Depth	6'-0" min.
Cantilever without supporting columns	6'-0" max.
Area	48 sq. ft. min.
Recess into Façade	4'-6" max.
Overall Width	10'-0" max. (D)

**M. Balconies: All (Continued)**

**Guard/Railing**

Allowed Types	Panel, Mesh, Horizontal
Height	Per Building Code (E)
Width Between Posts	3'-0" min. on center (F)

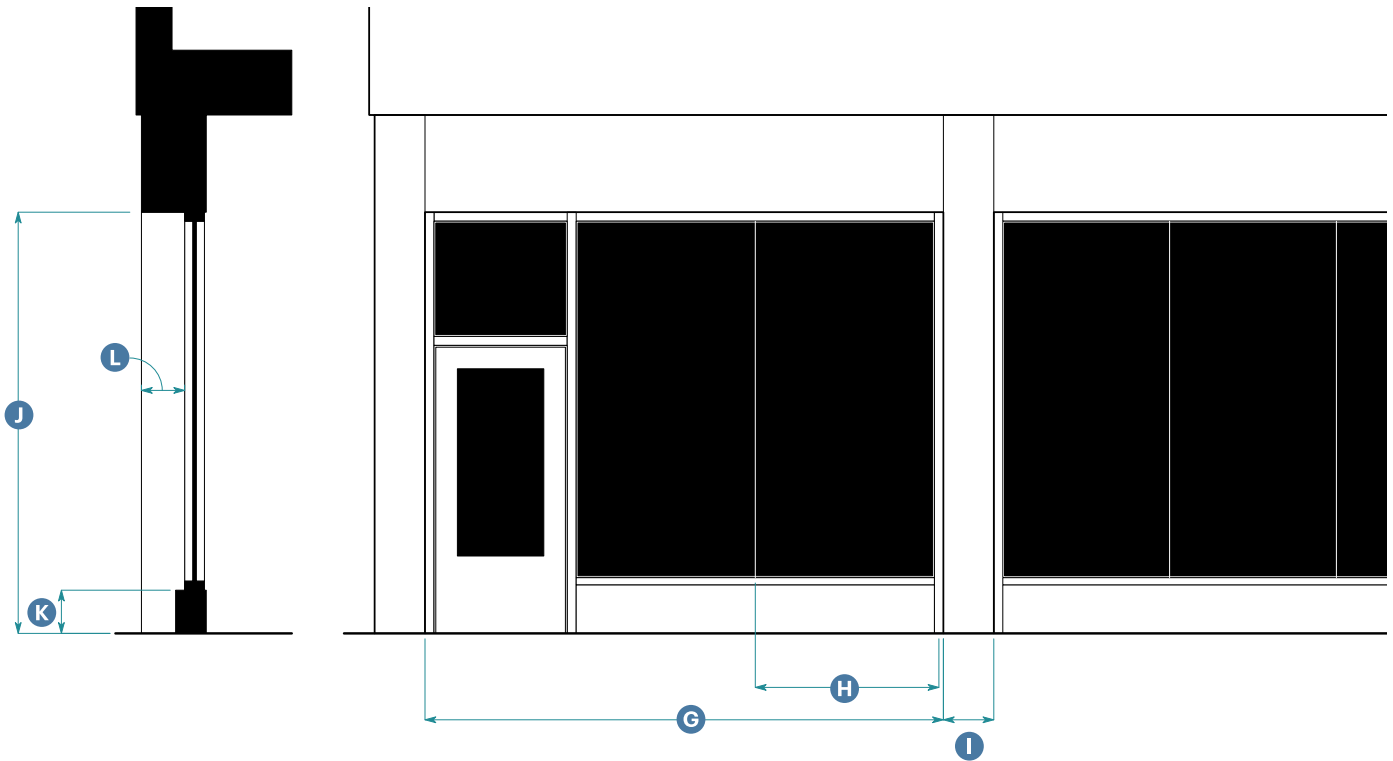

Storefront Section

Storefront Elevation

N. Storefronts: All		
<b>Width</b>		
Storefront Module	10'-0" min.; 25'-0" max.	G
Display Window	3'-0" min.; 6'-0" max.	H
Glazing Divisions	None required	
Distance Between Storefront Modules <sup>8</sup>	1'-0" min.; 4'-0" max.	I
<b>Height</b>		
Overall	N/A	
Head Height	10'-0" min.	J
Cornice	None	
Signage Band	None	
Bulkhead	0" min.; 2'-0" max.	K
<b>Horizontal Recess</b>		
Depth	6" min.; 9" max. <sup>9</sup>	L
Bulkhead shall be continuous, unless divided by pilaster.		

<sup>8</sup> May be expressed with pilasters. See Subsection L (Columns/Pilasters)

<sup>9</sup> No max. depth for residential entries.

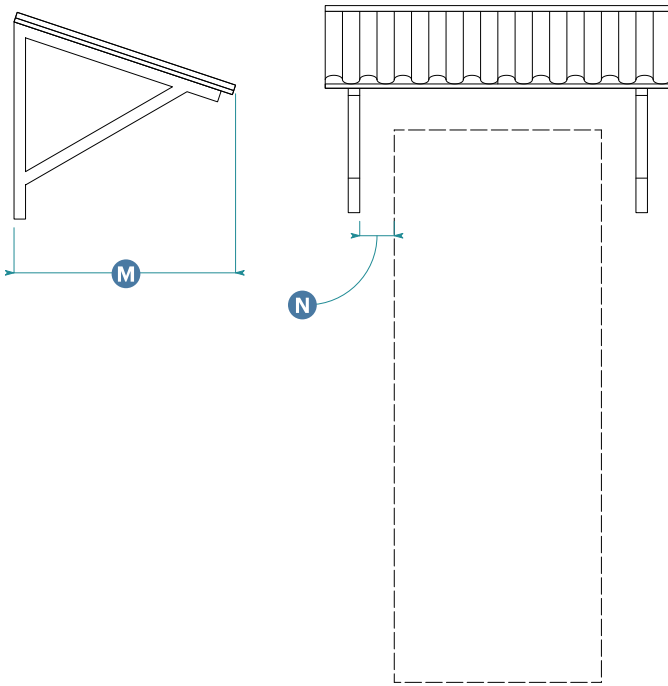

Awning Section

Awning Elevation

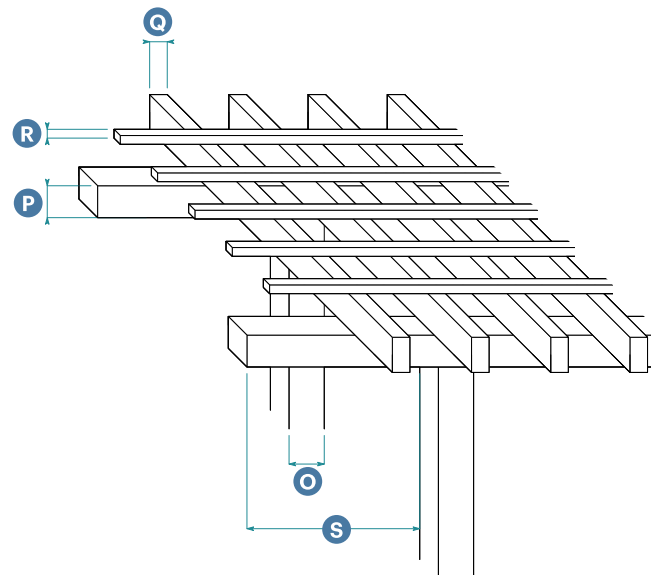

Trellis Diagram

O. Awning: Contemporary		
Awning Design		
Horizontal Projection <sup>10</sup>	3'-0" min.	(M)
Offset from Opening	1'-0" max.	(N)
Required Support Elements	Structural metal, tubing, or cable	

<sup>10</sup> Horizontal projection includes gutter, where occurs.

P. Trellises and Carports: All			
Dimensions	Wood	Metal	
Post	8" x 8" min.	4" x 4" min.	(O)
Main and Cross Beam	4" x 8" min. <sup>11</sup>	2" x 4" min.	(P)
Rafter	2" x 4" min.	1.5" x 3" min.	(Q)
Purlin or Lattice	2" x 2" min.	1.5" x 1.5" min.	(R)

Overhang		(S)
Beams	3'-0" max.	
Purlin or Lattice	2'-0" max.	
Trellis	1'-6" max.	

At balconies, overhangs may not project beyond balcony wall.

<sup>11</sup> Paired 2" x 8" members are allowed when placed on both sides of the supporting posts.

Q.1. Materials: Contemporary	
Element	Allowed Materials
<b>Building Wall</b>	
Cladding	Lap siding (wood, composite wood, fiber cement), stucco, concrete, metal panel <sup>12</sup>
<b>Base or Foundation</b>	
Base or Foundation	Wood, composite wood, stucco, brick, stone, concrete, fiber cement
<b>Roof and Roof Elements</b>	
Roofing <sup>13</sup>	Shingles (composite wood, dimensional or luxury asphalt shingles to mimic the look of wood); standing seam metal (black, white, or reflective metal finishes are prohibited)
Rake and Eave	Wood, composite wood, steel
Gutter Profile	Box
Materials	Metal
<b>Windows, Bay Windows, and Entry Doors</b>	
Entry Door	Wood, composite wood, metal, fiberglass
Window Frames	Wood, composite wood, aluminum-clad wood, steel
Glazing	Clear glass; shall not be tinted, mirrored, or colored
<b>Garages</b>	
Garage Door <sup>14</sup>	Wood, composite wood, metal opaque glass
<b>Balconies</b>	
Posts and Handrail	Metal
Railing	Metal panel, metal mesh, steel section, steel cable
Fascia	Wood, composite wood, metal
<b>Porches</b>	
Columns	Wood, composite wood, metal, fiberglass
Railing	Wood, composite wood, metal panel, metal mesh, steel section, steel cable

Q.1. Materials: Contemporary (Continued)	
Element	Allowed Materials
<b>Storefronts</b>	
Storefront Base (Bulkhead)	Wood, composite wood, concrete, metal panel, fiberglass
<b>Exterior Building Lighting</b>	
Body and Mount	Wrought iron, metal
Shield	Clear, translucent, punched, louvers
<b>Stairs and Ramps</b>	
Treads and Risers	Wood, composite wood, concrete, metal
Handrails	Wood, composite wood, metal
<b>Trellises and Carports</b>	
Spanning Members	Wood, steel
Trellis Posts	Wood, steel
Carport Support Posts	Wood, composite wood, stucco, steel
Connections	Steel, iron
<b>Trash Enclosure</b>	
Walls	Wood, composite wood, stucco
<b>Fences and Hedges</b>	
Walls	Stucco, brick, stone (faux manufactured stone veneer is prohibited), concrete, concrete block (coated and painted or pigmented to match the main building)
Fences <sup>15</sup>	Wood, composite wood, wrought iron, metal, chain link (vinyl-coated black or green)

All ends of hollow steel members must be capped.

<sup>12</sup> Metal panel wall cladding is allowed only if used as an accent and not for the entire wall surface.

<sup>13</sup> Applies to all pitched roofs and sloped roof parapets.

<sup>14</sup> Metal roll up doors are allowed only if not publicly visible. Metal security grilles are allowed for parking structures.

<sup>15</sup> Publicly visible fences may not be chain link unless screened with vines.

Q.2. Materials: Industrial	
Element	Allowed Materials
<b>Building Wall</b>	
Cladding	Lap siding (wood, composite wood, fiber cement), stucco, metal panel
<b>Base or Foundation</b>	
Base or Foundation	Brick, concrete
<b>Roof and Roof Elements</b>	
Roofing	Shingles (composite wood, dimensional or luxury asphalt shingles to mimic the look of wood); standing seam metal (black, white, or reflective metal finishes are prohibited)
Rake and Eave	Wood, composite wood, steel
Gutter Profile	Half-round, box
Materials	Metal
<b>Windows, Bay Windows, and Entry Doors</b>	
Entry Door	Wood, composite wood, metal, fiberglass
Window Frames	Wood, aluminum-clad wood, steel
Glazing	Clear glass; shall not be tinted, mirrored, or colored
<b>Garages</b>	
Garage Door <sup>16</sup>	Wood, composite wood, metal, opaque glass
<b>Balconies</b>	
Posts	Metal
Railing	Metal panel, metal mesh, steel section, steel cable
Handrail	Wood, composite wood, metal
Fascia	Wood, composite wood, metal
<b>Porches</b>	
Columns	Wood, composite wood, metal, fiberglass
Pedestal	Wood, composite wood, concrete, metal, fiberglass
Railing	Wood, composite wood, metal panel, metal mesh, steel section, steel cable

Q.2. Materials: Industrial (Continued)	
Element	Allowed Materials
<b>Storefronts</b>	
Storefront Base (Bulkhead)	Wood, composite wood, concrete, metal panel, fiberglass
<b>Exterior Building Lighting</b>	
Body and Mount	Wrought iron, metal
Shield	Clear, translucent, punched, louvers
<b>Stairs and Ramps</b>	
Treads and Risers	Metal, concrete
Handrails	Metal
<b>Trellises and Carports</b>	
Spanning Members	Steel
Trellis Posts	Steel
Carport Support Posts	Steel
Connections	Steel
<b>Trash Enclosure</b>	
Walls	Wood, composite wood, stucco
<b>Fences and Hedges</b>	
Walls	Stucco, brick, stone (faux manufactured stone veneer is prohibited), concrete, concrete block (coated and painted or pigmented to match the main building)
Fences <sup>17</sup>	Wood, composite wood, wrought iron, metal, chain link (vinyl-coated black or green)

All ends of hollow steel members must be capped.

<sup>16</sup> Metal roll up doors are allowed only if not publicly visible. Metal security grilles (including roll up function) are allowed for parking structures.

<sup>17</sup> Publicly visible fences may not be chain link unless screened with vines.

*This page intentionally left blank*



# Chapter 25.07 Exceptions

---

## Sections:

25.07.010	Purpose
25.07.020	Exceptions to Standards

---

### 25.07.010 Purpose

This Chapter establishes procedures for allowing minor deviations from certain standards for specific situations because of the prescriptive nature of the standards and as allowed by State law. Depending on the unique characteristics and dimensions on an individual parcel, it is possible that the full development potential of the zone may not be achievable even after applying the allowed exceptions in this Chapter.

---

### 25.07.020 Exceptions to Standards

- A. **Applicability.** This Section applies to all developments proposed under the ODDS. The Review Authority is allowed to grant exceptions for only the standards identified in this section.
1. Exceptions are applied separately for design sites with 10 percent or less slope and with over 10 percent average slope. Average slope for a lot is calculated using the methodology in *Section 30.15.030 (Determining Average Slope)*.
    - (a) Lots with an average slope of 10 percent or less may request an exception in Table 25.07.020.A (Exceptions to Standards for Design Sites with 10% or Less Average Slope).
    - (b) Lots with an average slope over 10 percent may request an exception in Table 25.07.020.B (Exceptions to Standards for Design Sites with Over 10% Average Slope).
- B. **Review Authority.**
1. The Review Authority for exception requests shall be the Community Development Director, except for standards which affect visibility at driveways and intersections, or standards in the right-of-way shall be reviewed by the Public Works Director.

- C. **Application Requirements.** Exception requests shall be reviewed and processed as follows:
1. If the development for which an exception is requested is being processed consistent with this Chapter, the review procedure shall be the same as for the main project application.
  2. Exception requests shall be accompanied from a written request by the applicant explaining the need for the exception and identifying all existing site conditions or features that prevent compliance with the specific standard.
  3. Granting of an exception does not eliminate other standards not specified in Table 25.07.020.A (Exceptions to Standards for Design Sites with 10% or Less Average Slope) or Table 25.07.020.B (Exceptions to Standards for Design Sites with Over 10% Average Slope).
- D. **Findings.** For the Review Authority to grant an exception, findings for the exception in Table 25.07.020.A (Exceptions to Standards for Design Sites with 10% or Less Average Slope) or Table 25.07.020.B (Exceptions to Standards for Design Sites with Over 10% Average Slope) are required.
- E. **Existing Site Condition.** An existing site condition is a legally permitted building or structure constructed on the site with a final inspection or certificate of occupancy, or a natural feature that exists as of the date of initial application submittal.
1. For purposes of this chapter, existing site conditions that prevent compliance with a standard include, but are not limited to, the following:
    - (a) A mature tree with at least one trunk measuring four inches in diameter or greater at four feet six inches above grade in height and not planned for removal or alteration with a permit per *Chapter 15.24 (Preservation of Trees)*.
    - (b) Utility infrastructure that is not required to be removed, relocated, or undergrounded per *Section 22.38.030 (Service Connection Requirements)*.
    - (c) A structure, site, cultural landscape, or feature designated or eligible to be designated historically significant based on the criteria in *Section 30.157.025 (Significance Criteria)*.
    - (d) Retaining wall necessary to retain or support soil.
    - (e) A watercourse identified on City of Santa Barbara Map Analysis and Printing System or any other map as may be adopted or established by ordinance.
  2. The existing site condition used as a basis for requesting an exception shall not be removed or altered in their footprint.

Table 25.07.020.A: Exceptions to Standards for Design Sites with 10% or Less Average Slope			
Administrative Relief Type	Findings/Criteria (All that Apply)	Allowed Administrative Relief and Conditions	Reference to Standard
<b>1. Design Site Dimensions</b>			
a. <b>Depth or Width</b> Decrease in the minimum required	<ul style="list-style-type: none"> <li>i. Existing site conditions prevent compliance with the design site dimension standards.</li> <li>ii. A non-rectangular parcel shape results in less than the required depth or width for a design site, preventing compliance with the standard.</li> <li>iii. Dimensions of the existing lot, subdivided prior to January 1, 2025, do not meet the minimum requirements for any building type allowed in Subsection B of the Zone.</li> </ul>	12" or 10% of the standard, whichever is greater	Chapter 25.02 (Zones), Subsection B (Building Types and Design Site Size) of the Zone
<b>2. Building Setbacks</b>			
a. <b>Front or Interior</b> Increase or decrease in the minimum or maximum required setback for a main building or wing	<ul style="list-style-type: none"> <li>i. Existing site conditions prevent compliance with the front setback standard.</li> <li>ii. Existing site conditions prevent compliance with the interior setback standard.</li> </ul>	12" or 10% of the standard, whichever is greater	Chapter 25.02 (Zones), Subsection D (Building Placement) of the Zone
b. <b>Façade within Façade Zone</b> Reduce the minimum amount of façade required within or abutting the façade zone	<ul style="list-style-type: none"> <li>i. Existing site conditions prevent compliance with the façade zone standard.</li> </ul>	12" or 10% of the standard, whichever is greater.  The horizontal unbuilt area resulting from this exception is landscaped per the standards in Section 25.03.050 (Landscape).	Chapter 25.02 (Zones), Subsection D (Building Placement) of the Zone
<b>3. Open Yard</b>			
a. <b>Width and Depth</b> Reduce minimum width or depth dimension	<ul style="list-style-type: none"> <li>i. Existing site conditions prevent compliance with the open yard dimensions standard.</li> </ul>	12" or 10% of the standard, whichever is greater, without reducing minimum area required.	Chapter 25.04 (Building Types), Subsection F (Open Yard) of the Building Type
b. <b>Area</b> Reduce minimum area	<ul style="list-style-type: none"> <li>i. Existing site conditions prevent compliance with the open yard area standard.</li> </ul>	Up to 10% of the standard	

**Table 25.07.020.A: Exceptions to Standards for Design Sites with 10% or Less Average Slope (Continued)**

Administrative Relief Type	Additional Findings/Criteria (All that Apply)	Allowed Administrative Relief and Conditions	Reference to Standard
<b>4. Building Footprint</b>			
<p>a. <b>Size of Main Body or Wing</b> Increase in the maximum width or length</p>	<p>i. Existing site conditions prevent compliance with the building footprint standard.</p>	<p>12" or 10% of the standard, whichever is greater</p> <p>The wing is one-story less in height than the main body; and</p> <p>The building complies with the setbacks of the zone or as allowed to be adjusted by this Section.</p>	<p>Chapter 25.04 (Building Types), Subsection C (Building Size and Massing) of the Building Type</p>
<b>5. Parking Standards</b>			
<p>a. <b>Primary and Secondary Front Setback</b> Reduce the required parking setback</p>	<p>i. Existing site conditions prevent compliance with the parking setback standard.</p>	<p>12" or 10% of the standard, whichever is greater</p> <p>The driveway is in compliance with the zone standards; and</p> <p>The ground floor space remains occupiable in compliance with the zone standards, as allowed to be adjusted by this Section; and</p> <p>The setback reduction maintains visibility at driveways and intersections, and does not affect standards for the right-of-way.</p>	<p>Chapter 25.02 (Zones), Subsection E (Parking) of the Zone</p>

**Table 25.07.020.A: Exceptions to Standards for Design Sites with 10% or Less Average Slope (Continued)**

Administrative Relief Type	Additional Findings/Criteria (All that Apply)	Allowed Administrative Relief and Conditions	Reference to Standard
<b>5. Parking Standards (Continued)</b>			
<p>b. <b>Primary Front Vehicle Access</b> Allow vehicle access from primary front on corner design sites</p>	<p>i. Existing site conditions prevent compliance with the vehicle access standard.</p>	<p>Vehicular access from the primary front</p> <p>The driveway is in compliance with the zone standards; and</p> <p>The ground floor space remains occupiable in compliance with the zone standards, as allowed to be adjusted by this Section; and</p> <p>The existing lot is at least 50' wide; and</p> <p>The proposed driveway is not aligned with any driveway on the opposite side of the street.</p>	<p>Chapter 25.02 (Zones), Subsection E (Parking) of the Zone</p>
<p>c. <b>Alley Access</b> Allow vehicle access from primary or secondary front when alley access exists.</p>	<p>i. The alley does not meet vehicle access requirements.</p>	<p>Vehicular access from primary or secondary front</p>	<p>Section 25.03.100 (Parking Techniques)</p>
<b>6. Landscape</b>			
<p>a. <b>Front Setback Shade Tree</b> Minimum required in NM zone</p>	<p>i. A certified arborist report identifies site conditions that prevent compliance with the standard.</p>	<p>No shade tree required</p>	<p>Section 25.03.050 (Landscape)</p>
<b>7. Screening</b>			
<p>a. <b>Roof-Mounted Equipment Screening Height</b> Decrease the minimum height of the architectural element screening the roof-mounted mechanical equipment</p>	<p>i. Height of architectural element used for screening results in exceeding maximum height limit of the building.</p>	<p>Up to 10% lower than the object being screened</p> <p>The roof-mounted equipment being screened is not publicly visible</p>	<p>Section 25.03.080 (Screening)</p>

Table 25.07.020.A: Exceptions to Standards for Design Sites with 10% or Less Average Slope (Continued)

Administrative Relief Type	Additional Findings/Criteria (All that Apply)	Allowed Administrative Relief and Conditions	Reference to Standard
<b>7. Screening (Continued)</b>			
b. <b>Free-Standing Equipment Location</b> Reduce minimum required setback	i. Existing site conditions prevent compliance with the front setback standard. ii. Existing site conditions prevent compliance with the interior setback standard.	12" or 10% of standard, whichever is greater	Section 25.03.080 (Screening)
<b>8. Block Size</b>			
a. <b>Block Dimensions</b> Allow larger blocks	i. Preservation of existing building or buildings within the boundaries of a Sustainable Neighborhood Plan prevents compliance with the standard.	Maximum block length and perimeter standards to be increased to encompass the building and all setbacks required by the applicable zone.	Subsection 25.03.160.C.3 (Block and Street Standards)
<b>9. Building Type</b>			
a. <b>Stories</b> Allow additional story	i. The existing site conditions or development standards of Chapter 25.04 (Building Types) prevent compliance with the minimum unit quantity required (Subsection 25.02.030.D.1 (Minimum Unit Quantities))	One additional story, not to exceed 4 stories or the maximum height allowed in the zone, for the Side Court, Medium Courtyard, and Large Multiplex Building Types	Chapter 25.04 (Building Types) Subsection C (Building Size and Massing) of the Side Court (25.04.100), Medium Courtyard (25.04.110), or Large Multiplex (25.04.120)

Table 25.07.020.B: Exceptions to Standards for Design Sites with Over 10% Average Slope			
Administrative Relief Type	Additional Findings/Criteria (All that Apply)	Allowed Administrative Relief and Conditions	Reference to Standard
<b>1. Design Site Dimensions</b>			
a. <b>Depth</b> Decrease in minimum design site depth	i. Existing average slope exceeds 15%.	12" or 10% of the standard, whichever is greater	Chapter 25.02 (Zones) Subsection B (Building Types and Design Site Size) of the Zone
<b>2. Building Setbacks</b>			
a. <b>Front and Interior</b> Increase or decrease in the minimum or maximum required setback for a main building or wing	i. Existing site conditions prevent compliance with the front setback standard. ii. Existing site conditions prevent compliance with the interior setback standard.	12" or 10% of the standard, whichever is greater	Chapter 25.02 (Zones), Subsection D (Building Placement) of the Zone
b. <b>Front</b> Decrease in minimum to maximum required setback areas for main building or wing	i. Front 50' of the design site exceeds 20% slope. ii. Front 25' of the design site exceeds 20% slope.	Front setback reduced to 10' min. The Façade Zone is not reduced. Front setback reduced to 5' min. The Façade Zone is not reduced.	
<b>3. Open Yard</b>			
a. <b>Width and Depth</b> Reduce minimum width or depth	i. Existing site conditions prevent compliance with the open yard dimension standard.	12" or 10% of the standard, whichever is greater, without reducing minimum area required.	Chapter 25.04 (Building Types) Subsection F (Open Yard) of the Building Type
b. <b>Area</b> Reduce minimum area	i. Existing site conditions prevent compliance with the open yard area standard.	Up to 10% of the standard	

**Table 25.07.020.B: Exceptions to Standards for Design Sites with Over 10% Average Slope (Continued)**

Administrative Relief Type	Additional Findings/Criteria (All that Apply)	Allowed Administrative Relief and Conditions	Reference to Standard
<b>4. Parking Standards</b>			
<p>a. <b>Primary and Secondary Front Setback</b> Reduce the required parking setback</p>	<p>i. Existing site conditions prevent compliance with the parking setback standard.</p> <hr/> <p>ii. The front 50' of parcel exceeds 20% slope.</p>	<p>12" or 10% of the standard, whichever is greater</p> <p>The driveway is in compliance with the zone standards; and</p> <p>The ground floor space remains occupiable in compliance with the zone standards, as allowed to be adjusted by this Section; and</p> <p>The setback reduction maintains visibility at driveways and intersections, and does not affect standards for the right-of-way.</p> <hr/> <p>Required parking is allowed to be located between the right-of-way and the building:</p> <p>a. 20' parking setback if street facing, 10' parking setback for non-street facing.</p> <p>b. Max 50% of primary or secondary front lot width</p> <p>The driveway is in compliance with the zone standards; and</p> <p>The ground floor space is between the street and the parking, remains occupiable, and is at least 15' deep.</p>	<p>Chapter 25.02 (Zones) Subsection E (Parking) of the Zone</p>



**Table 25.07.020.B: Exceptions to Standards for Design Sites with Over 10% Average Slope (Continued)**

Administrative Relief Type	Additional Findings/Criteria (All that Apply)	Allowed Administrative Relief and Conditions	Reference to Standard
<b>4. Parking Standards (Continued)</b>			
b. <b>Primary Front Vehicle Access</b> Allow vehicle access from primary front on corner design sites	i. Existing site conditions prevent compliance with the vehicle access standard.	Vehicular access from the primary front  The driveway is in compliance with the zone standards; and.  The ground floor space remains occupiable in compliance with the zone standards, as allowed to be adjusted by this Section; and  The existing lot is at least 50' wide; and  The proposed driveway is not aligned with any driveway on the opposite side of the street; and  The design site average slope along the secondary front exceeds 15%	Chapter 25.02 (Zones), Subsection E (Parking) of the Zone

Table 25.07.020.B: Exceptions to Standards for Design Sites with Over 10% Average Slope (Continued)			
Administrative Relief Type	Additional Findings/Criteria (All that Apply)	Allowed Administrative Relief and Conditions	Reference to Standard
<b>5. Site Grading</b>			
<p>a. <b>Retaining Wall Height</b> Increase in maximum retaining wall height or length</p>	<p>i. Existing slopes average 20% slope.</p> <p>ii. The retaining wall is necessary to accommodate the building and required site access and parking.</p>	<p>Increase in retaining wall height up to 10' along interior design site line.</p> <p>Increase in retaining wall height up to 12' within the building footprint if overall building height in compliance with zone standards.</p> <p>The retaining wall or series of retaining walls are not visible from the adjacent public sidewalk or abutting lots; and</p> <p>Retaining walls not within the building footprint are less than 50' in total length along the interior design site line opposite the primary front or any one design site line; and</p> <p>The retaining wall is the result of excavation (cut).</p>	<p>Section 25.03.120 (Retaining Walls)</p>
<b>6. Landscape</b>			
<p>a. <b>Front Setback Shade Tree</b> Minimum required in NM zone</p>	<p>i. A certified arborist report identifies site conditions that prevent compliance with the standard.</p>	<p>No shade tree required</p>	<p>Section 25.03.050 (Landscape)</p>
<b>7. Screening</b>			
<p>a. <b>Roof-Mounted Equipment Screening Height</b> Decrease the minimum height of the architectural element screening the roof-mounted mechanical equipment</p>	<p>i. Height of architectural element used for screening results in exceeding maximum height limit of the building.</p>	<p>Up to 10% lower than the object being screened</p> <p>The roof-mounted equipment being screened is not publicly visible</p>	<p>Section 25.03.080 (Screening)</p>

**Table 25.07.020.B: Exceptions to Standards for Design Sites with Over 10% Average Slope (Continued)**

Administrative Relief Type	Additional Findings/Criteria (All that Apply)	Allowed Administrative Relief and Conditions	Reference to Standard
<b>7. Screening (Continued)</b>			
b. <b>Free- Standing Equipment Location</b> Reduce minimum required setback	i. Existing site conditions prevent compliance with the front setback standard. <hr/> ii. Existing site conditions prevent compliance with the interior setback standard.	12" or 10% of the standard, whichever is greater	Section 25.03.080 (Screening)
<b>8. Building Type</b>			
a. <b>Stories</b> Allow an additional story	i. The existing site conditions or development standards of Chapter 25.04 (Building Types) prevent compliance with the minimum unit quantity required (Subsection 25.02.030.D.1 (Minimum Unit Quantities))	One additional story, not to exceed 4 stories or the maximum height allowed in the zone, for the Side Court, Medium Courtyard, or Large Multiplex Building Type	Subsection C (Building Size and Massing) of the Side Court (25.04.100), Medium Courtyard (25.04.110), or Large Multiplex (25.04.120)

*This page intentionally left blank*

# Chapter 25.08 Definitions

---

## Sections:

25.08.010	Purpose
25.08.020	Definitions

---

### 25.08.010 Purpose

This Chapter provides definitions for specialized terms and phrases used in Title 25. All other applicable definitions in the Santa Barbara Municipal Code apply.

---

### 25.08.020 Definitions

#### A. Definitions

**Arcade.** A series of open or closed arches, supported by pilasters or columns.

**Architectural Feature.** Exterior building element intended to provide ornamentation to the building massing including, but not limited to the following: eaves, cornices, bay windows, window and door surrounds, light fixtures, canopies, and balconies.

#### B. Definitions

**Baluster.** A small column, shaft, or other vertical member commonly used in a balustrade to support a top rail or coping.

**Base of Building.** The lowest division of a building, adjacent to the ground. A building's base may occupy the lowest floor level or levels, or it may be expressed with a water table. In the former case, the base is typically articulated by a change of material or projecting element such as a molding at the upper boundary of the lowest floor or floors. If a water table is used, the lowest portion of the ground-floor wall is finished in a different, more durable material or color, usually articulated with a molding at the upper boundary where the material change occurs. Also called base.

**Bay.** Any division of a building between vertical lines or planes that run entirely through solid components of the building, including the entire space included between consecutive structural supports.

**Block Length.** The horizontal distance from the right-of-way on one end of the block to the right-of-way on the other end along the same street.

**Block Perimeter.** The aggregate of all sides of a block bounded by the abutting rights-of-way.

**Bracket.** Structural or ornamental elements designed to strengthen the connection between components of a structure that meet at an angle.

**Buildable Area.** The horizontal area on a lot in which a building is allowed to be constructed.

**Building.** See *Section 30.300.020 ("B")*, Building.

**Building, Block-Scale.** A building that is individually as large as a block or individual buildings collectively arranged along a street to form a continuous façade as long as most or all of a block.

**Building, House-Scale.** A building that is the size of a small-to-large house and detached from other buildings, typically ranging from 24 feet to as large as 80 feet overall, including wings.

**Building, L-shaped.** A horizontal form for the main body of a building or a massing composition which has an extension at a right angle to the length of a building. Also called an "EII"-Shaped Building.

**Building, O-shaped.** A horizontal form for the main body of a building or a massing composition which has the shape of the capital letter O except that the form typically includes rectilinear corners.

**Building, U-shaped.** A horizontal form for the main body of a building or a massing composition which has the shape of the capital letter U. Also called a C-shaped Building.

**Building Form.** The overall shape and dimensions of a building.

**Building Type.** A structure defined by its combination of configuration, disposition, and function. See also, Chapter 25.04 (Building Types).

**Bulkhead.** The area of the storefront between the sidewalk and the base of the display window.

### C. Definitions

**Capital.** Uppermost segment of a column or pilaster, directly supporting the beam, lintel, or arch above.

**Chamfered.** An edge between two faces of an external wall or window, typically at a symmetrical, 45 degree angle creating a beveled edge to the window or building rather than a 90 degree corner.

**Column.** A vertical shaft extending from the ground or from one part of the structure to another.

**Community Open Space.** A publicly accessible outdoor area. See Subsection 25.03.160.D (Community Open Space).

**Coping.** The horizontal covering of the top of a wall or parapet.

**Corbel.** A type of bracket, supporting another element from below and used for structural and aesthetic purposes.

**Corner Element.** A physical distinction in a building at the corner of two streets.

**Cornice.** A horizontal projection traditionally used to join a roof to the wall below and protect the wall from rainwater. The cornice forms the uppermost part of an entablature and may appear secondarily in locations other than at the building's eave or parapet, such as the upper boundary of a base story.

## D. Definitions

**Depth, Ground-Floor Space.** The distance from the street-facing façade to the rear interior wall of the ground-floor space available to an allowed use.

**Design Site.** A portion of land within a parcel, delineated from other design sites or parcels, to accommodate no more than one building type. The main purpose of a design site is to allow a parcel large enough to contain more than one building type to contain multiple building types while not requiring the legal subdivision of the parcel into additional parcels. "Design Site" and all related definitions and standards are applicable only to projects using Title 25 of the Municipal Code. See also, Section 25.02.040 (Design Sites).

**Area, Design Site.** The total square footage or acreage of horizontal area included within the design site lines.

**Line, Design Site.** The perimeter and geometry of a design site demarcating one design site from another.

**Distance Between Entries.** The horizontal distance between entrances to a building or buildings, measured parallel to the façade.

**Door.** See Section 30.300.040 ("D"), Door.

**Full Glass.** Door glass framed by the outermost rails and stiles of the door.

**Half Glass.** Door glass placed within the upper half of a door, framed by upper and middle rails and stiles.

**Vision Glass.** Door glass located within the upper portion of a door, occupying no more than one third of the door and designed to provide visibility from the inside to the outside rather than to illuminate the interior.

**Overhead.** Doors constructed in horizontally hinged sections that are equipped with hardware that rolls the sections into an overhead position, clear of the opening.

## E. Definitions

**Eave.** See Section 30.300.050 ("E"), Eave.

**Eave, Closed.** Eaves with projecting roof members closed from view by boarding.

**Eave, Open.** Overhanging eaves where the rafters are exposed at the eaves and visible from below.

**Eave, Returned.** Eave that extends around corner and terminates into gable end or rake wall.

**Entablature.** A superstructure which lies horizontal upon pilasters or columns, and is composed of an architrave, frieze, and cornice.

**Entasis.** A slight convex curve in the shaft of a column, introduced to correct the visual illusion of concavity created by the vertical load. In columns with entasis, the diameter at the top of the shaft is typically around five sixths of the diameter at the bottom.

**Entry.** An opening, including, but not limited to, a door, gateway, or gate, that allows access to a building.

**Expression Line.** A horizontal molding, projection, or other boundary articulating one portion of a façade from the portion above.

## F. Definitions

**Façade.** See *Section 30.300.060 ("F")*, Façade.

**Façade, Front.** The exterior wall of a building adjacent to a primary or secondary front lot line/design site line. Also called a Main Façade.

**Façade, Interior.** The exterior wall of a building adjacent to the interior lot line/design site line or opposite the front façade.

**Façade Zone.** The area between the minimum and maximum front setback lines along the primary front of a design site and along the secondary front of a corner design site where the building façade is required to be placed. The zone standards identify the minimum amount of façade to abut or be placed in the façade zone. "Façade Zone" and all related definitions and standards are applicable only to projects using Title 25 of the Municipal Code. See also, Section 25.02.050 (Façade Zone).

**Fascia.** A horizontal board or moulding appended to the end of joists or rafters, as part of roof rake or eave assembly or as part of balcony platform assembly.

**Finish Level, Ground Floor.** The elevation of the top of the ground floor structure to which flooring finishes and materials are applied.

**Fluting.** Shallow grooves running vertically along a column or pilaster surface.

**Frontage.** A physical element configured to connect the building façade to the back of the sidewalk abutting a street or public open space depending on the intended physical character of the zone. "Frontage" and all related definitions and standards are applicable only to projects using Title 25 of the Municipal Code. See also, Chapter 25.05 (Frontages).

## G. Definitions

**Gable.** A vertical wall in the shape of a triangle formed between the cornice or eave and the ridge of the roof.

**Garage.** See *Section 30.300.160 ("P")*, Parking, Covered.

**Glazing.** Openings in a building in which glass is installed.

**Glazing Division.** A module of glass, known as a lite, divided by real or simulated muntins.

## H. Definitions

No specialized terms beginning with the letter H are defined at this time.

## I. Definitions

No specialized terms beginning with the letter I are defined at this time.

## J. Definitions

No specialized terms beginning with the letter J are defined at this time.

## K. Definitions

No specialized terms beginning with the letter K are defined at this time.



## L. Definitions

**Lighting.** Wall mounted light fixture.

**Body.** The part of the light fixture that holds the shield.

**Mount.** The part of the light fixture mounted to the building, sometimes called the backplate or the canopy, including the chain or armature that holds the body.

**Shield.** The part of the light that controls direction, strength, and spread. Also called a shade.

**Lintel.** A horizontal member designed to support the wall above it, such as above an opening. When expressed on a façade, a lintel adds aesthetic value by communicating structural stability at a discontinuity in the wall.

## M. Definitions

**Massing.** The overall shape or arrangement of the bulk or volume of a building and structures.

**Mortise and Tenon.** A system in which wood members are joined through the use of intersecting cuts, secured by wooden pegs.

**Mullion.** Vertical bar providing structural support between windows.

**Muntin.** Pieces of non-glazing material to secure multiple panes of glass, or lites, within a window. Muntins serve to articulate glazing divisions.

## N. Definitions

No specialized terms beginning with the letter N are defined at this time.

## O. Definitions

No specialized terms beginning with the letter O are defined at this time.

## P. Definitions

**Paneling.** Solid raised or recessed parts of a column, pilaster, or pedestal, surrounded by stiles and rails.

**Panels.** Solid raised or recessed parts of a door, surrounded by stiles, rails, and mullions.

**Parapet.** A low wall along the edge of a roof or the portion of a wall that extends above the roof line.

**Parking, Covered.** See *Section 30.300.160 ("P")*, Parking, Covered.

**Podium.** Parking spaces located in an at-grade garage with shared ingress/egress and maneuvering areas located under the building. The podium parking garage has occupiable space above the garage level.

**Subterranean.** Parking spaces located below the finished grade of the building.

**Tuck-Under.** Parking spaces located in an at-grade garage or carport accessed by an open driveway. Tuck-under parking has occupiable space above the garage level.

**Pedestal.** A substructure that may be placed under a column or pilaster.

**Pedestrian Orientation.** A physical structure or place with design qualities and elements that contribute to an active, inviting, and pleasant place for pedestrians.

**Pediment.** A triangular or arched element above the lintel or entablature of a door or window.

**Pilaster.** A column engaged to and projecting from a wall.

**Pitch.** The slope of a roof expressed as vertical rise per measure of length.

#### Q. Definitions

No specialized terms beginning with the letter Q are defined at this time.

#### R. Definitions

**Rail.** Any of the horizontal members of the structure of a door or a window sash.

**Rake.** The junction of a sloped roof and the wall of a building, following the slope of the roof.

**Recessed Entry.** An entrance to a building that is set back from the façade of the building.

**Roof.** See Section 30.300.180 ("R"), Roof.

**Gable Roof.** Roof with sloped surfaces that intersect along a ridge at the uppermost edge.

**Hip Roof.** Roof with sloped sides rising from multiple intersecting walls. Roof surfaces meet along convex ridges that rise from outside corners, convex valleys that rise from inside corners, and convex ridges at the uppermost edges.

**Shed Roof.** Roof with its surface sloping in a single direction.

**Flat Roof.** Nearly level roof which relies on subtle variations in its surface for drainage and is typically surrounded by a parapet.

#### S. Definitions

**Sash.** A panel of a window, framed using rails and stiles.

**Shopfront Base.** A very low wall, that does not include glass, between the bottom of the display windows of a shopfront and the adjacent sidewalk. Also called a bulkhead.

**Sidelight.** A glazed panel at the side of a doorway.

**Signage Band.** The frieze of the storefront entablature, typically used to support wall-mounted lettering and signage.

**Sill.** The horizontal bottom member of a window frame.

**Stile.** Any of the vertical members of the structure of a door or a window sash.

**Storefront.** The majority portion of a shopfront frontage that consists of the display window or entrance and its components, including windows, doors, transoms, and sill pane.

## T. Definitions

**Transom.** Glazed lite or window set above a door that is the same width or no wider than the door frame, including sidelights if present.

**Trim.** A narrow strip of wood, moulding, or other material as a surface decoration or the covering for joints and seams between building structure and window and door openings, or at wall edges.

## U. Definitions

No specialized terms beginning with the letter U are defined at this time.

## V. Definitions

**Valance.** The panel of drapery at the front edge of a canopy or awning.

## W. Definitions

**Walkable/Walkability.** The condition in which an area is highly interconnected with other areas by more through streets than dead-end streets, providing more options for access to recreational walking or for walking to work, transit, errands, shopping, or restaurants.

**Wall Plane.** A vertical surface defined by the façades of buildings.

**Window.** See *Section 30.300.230 ("W")*, Window.

**Window, Accent.** A window typically smaller in its vertical dimension, and occurring less than a typical window.

**Window, Awning.** A window with one or more sashes hinged horizontally along the top rail.

**Window, Bay.** See *Section 30.300.020 ("B")*, Bay Window.

**Window, Casement.** A window with at least one sash hinged vertically to swing open.

**Window, Dormer.** A vertical window opening with surrounding wall and roof construction projecting from a sloping roof.

**Window, Double Hung.** A window with two sashes arranged one above the other, both of which are moveable in the vertical direction.

**Window, Fixed.** A window or part of one that cannot be moved or opened.

**Window, Ganged.** An opening composed of two or three typical windows, of which one typical window may be replaced with a picture window.

**Window, Picture.** A fixed window designed to take advantage of a view by reducing visual obstruction. Picture windows do not have glazing division.

**Window, Single Hung.** A window with two sashes arranged one above the other, one of which is moveable in the vertical direction.

**Window, Typical.** A regular recurring window (i.e., size or lite pattern) on a façade.

**Wing.** A structure of at least five feet in depth physically attached to, and secondary to, the main body of a main building.

**X. Definitions**

No specialized terms beginning with the letter X are defined at this time.

**Y. Definitions**

No specialized terms beginning with the letter Y are defined at this time.

**Z. Definitions**

No specialized terms beginning with the letter Z are defined at this time.